

SAMSUNG

SYSTEM AIR CONDITIONER

OUTDOOR UNIT

AM036FXMDCH

AM048FXMDCH

AM053FXMDCH

SERVICE *Manual*

AIR CONDITIONER



CONTENTS

- Product Specifications
- Disassembly and Reassembly
- Troubleshooting
- PCB Diagram
- Wiring Diagram
- Reference Sheet
- Check Operation & Amount of Refregent Automatically Checking

Refer to the service manual in the GSPN(see the rear cover) for the more information.

Contents

■ Product Specifications	1
1. The Feature of Product.....	1
1-1 Featres.....	1
2. Product Specifications.....	7
■ Disassembly and Reassembly	8
■ Troubleshooting	18
1. Error Display	18
2. Error Code.....	19
3. How to take measures for each symptom.....	20
3-1 Communicaion error between indoor and outdoor units during tracking(Error Code:E201)	20
3-2 Communicaion error between indoor and outdoor units during tracking(Error Code:E202).....	21
3-3 Communicaion error (1minute)between Main and Sub Micoms of an Outdoor unit or among Outdoor Units (Error Code:E203)	22
3-4 Outdoor temperature sensor error (Error Code : E221, E231, E251, E269)	23
3-5 High pressure temperature sensor error (Open/Short) (Error Code : E291) Low pressure temperature sensor error (Open/Short) (Error Code : E296)	24
3-6 Compressor down by antifreeze control (Error Code: E403)	25
3-7 Comp. down due to a protective control of high pressure (Error Code : E407)	26
3-8 Comp. down due to a protective control of low pressureError Code : E410)	27
3-9 Comp. down due to a discharge temperature sensor of a compressor (Error Code : E416).....	28
3-10 Reverse phase detection error (3Phase outdoor unit) (Error Code : E425).....	29
3-11 ESC EEV open error (Error Code : E438).....	30
3-12 Refrigerant leakage error (Error Code : E439).....	31
3-13 Prohibition of the compressor operation due to outdoor temperature (Error Code : E440, 441).....	32
3-14 Refrigerant leakage error (during operation) (Error Code : E443).....	32
3-15 Outdoor unit fan error (Error Code : E458, 475).....	33
3-16 Comp down due to OLP temperature control (Error Code : E463)	34
3-17 Compressor starting/rotation error (Error Code : E461, E467)	35
3-18 Current error / PFC overload error (Error Code : E462, E484).....	37
3-19 IPM over current error (Error Code : E464).....	38
3-20 DC-Link voltage under/over error (Error Code : E466).....	41
3-21 Gas leak error (Error Code : E554).....	43
3-22 Others	45
■ PCB Diagram	46
■ Wiring Diagram	52
■ Reference Sheet	53
1. Refrigerant cycle diagram.....	53
2. Nomenclature	54
■ Check Operation & Amount of Refrigerant Automatically Checking	55
1. Check Operation.....	55
1-1 Check Operation	55
1-2 How to trouble of the "Undetermined".....	56
1-3 Automatic Commissioning Error Code.....	63
2. Amount of Refrigerant Automatically Checking	64

Product Specifications

1. The Feature of Product

1-1 Feature

Structure of outdoor unit

High performance BLDC fan motor

- 33% more efficient compare to AC motor
- Wide speed control range, less noise generation

High efficient propeller fan

- Reduced noise on outdoor unit
- Improved heat exchange rate

Anti-chloride coated outdoor unit heat exchanger

- Anti-corrosion /erosion G-Fin provide stable heat exchanging performance

Turbo Inter-cooler

- Long piping up to 175m with sub-cooling
- Up to 50m levela difference is allowed for installation

Twin BLDC compressor

- Increased energy efficiency compare to conventional compressor
- Stable operation with 80% decreased vibration

High efficient heat exchanger

High efficient G-Fin & epoxy acrylic coating has increased heat transfer and hydrophilicity on heat exchanger.

		DVM Mini	Company A
Diameter		Ø8	Ø7
Heat transfer surface area		19%	
Pressure loss in heat exchanger	Evaporation	↑ 14.1%	
	Condensation	↓ 10.3%	
Internal heat transfer performance		↓ 30.8%	
Pressure resistance		Same	

Feature (cont.)

■ Application of wide fin

High efficient heat exchanger has been applied, therefore it delays the onset of frost formation and increased heat transfer efficiency.

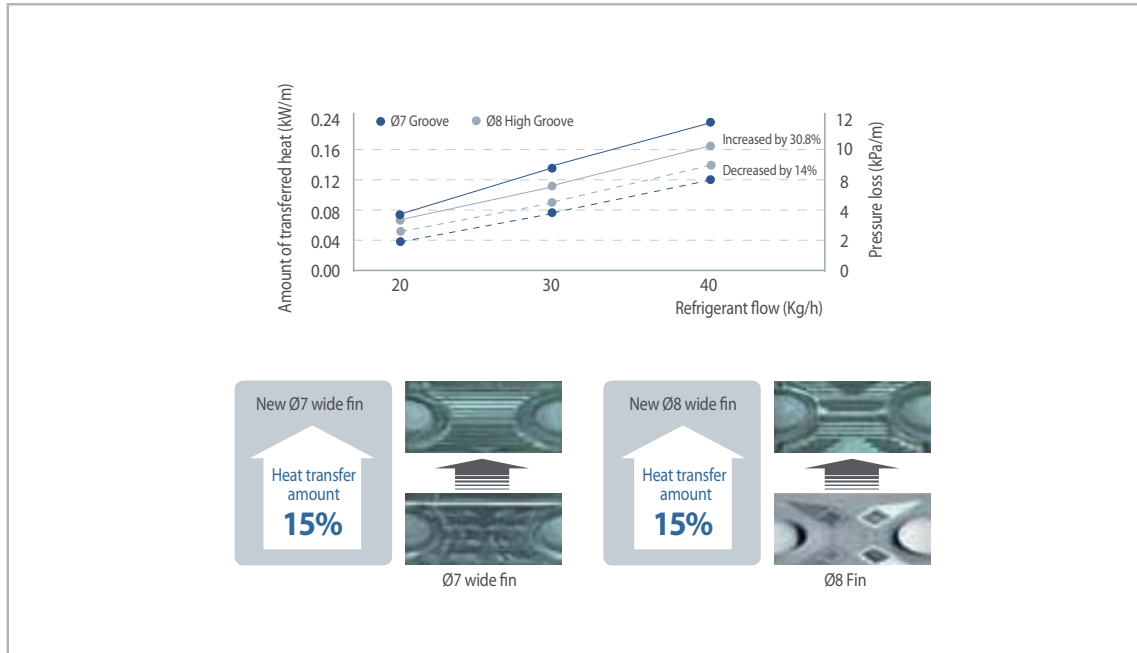

■ Optimized cooling/heating and increased system efficiency! Liquid EEV & Turbo Inter-cooler

• Liquid EEV for increased efficiency of the system

Through Liquid EEV, controlling of valve opening has become more efficient and it achieved optimized system efficiency and minimized noise from the refrigerant in the indoor unit.

• Turbo Inter-cooler

High performing shell & tube type heat exchanger has been applied to secure cooling/heating efficiency. It has secured enough subcooling to acquire reliability on long piping and it also increased cooling/heating efficiency.

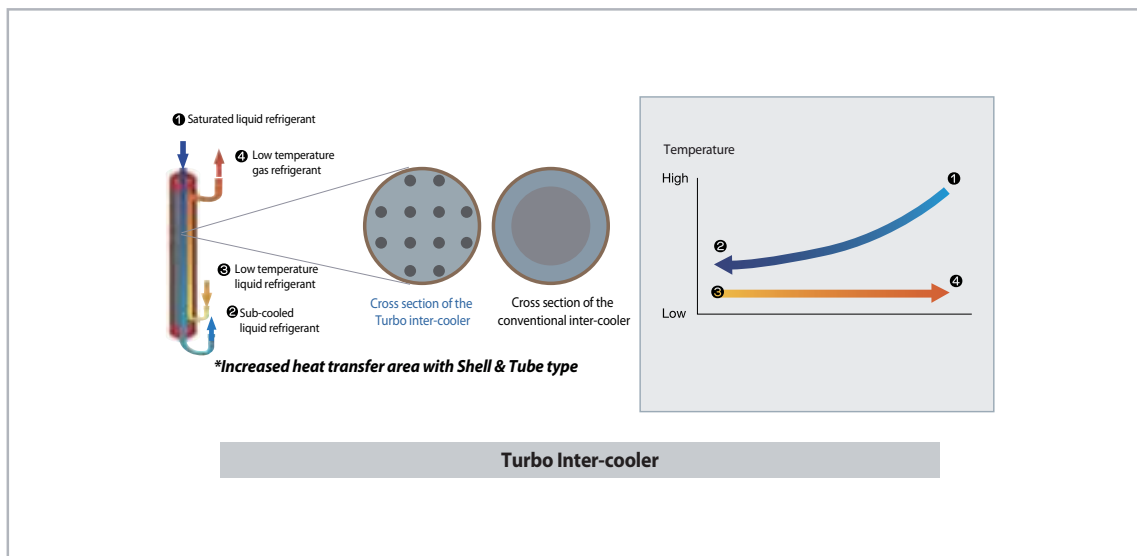

Feature (cont.)

■ Reinforced corrosion resistance on the heat exchanger

To prevent corrosion of the products which is installed in saline area, corrosion resistance has been reinforced.

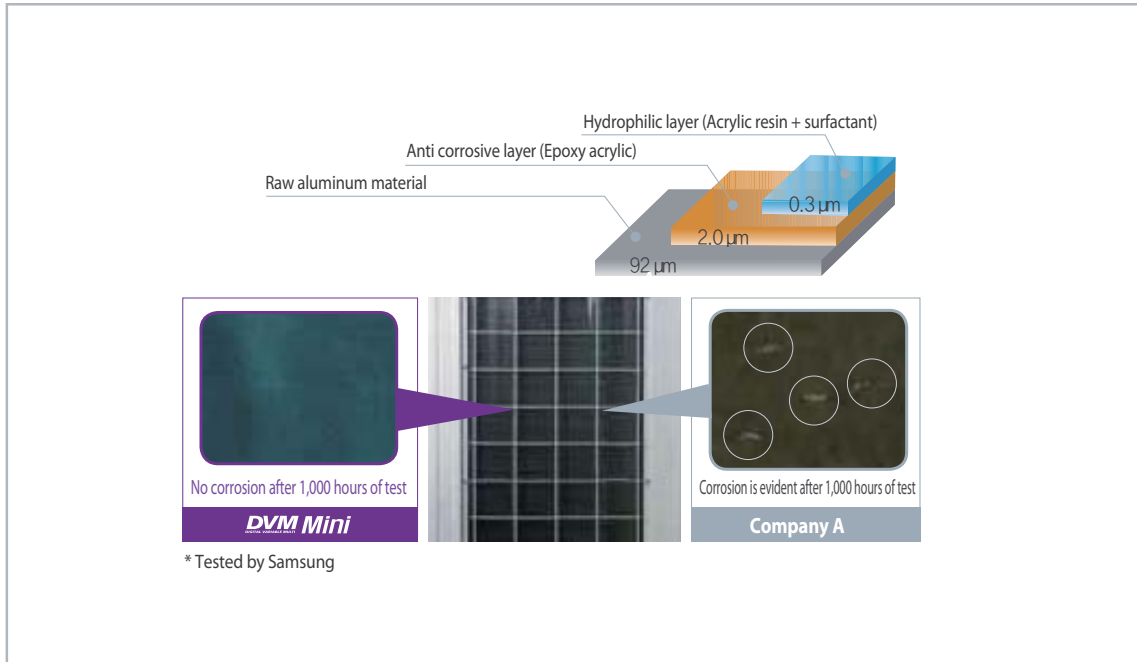

■ Long piping/High level difference technology

Longest piping length is allowed up to 175m (equivalent length) and Maximum 50m of level difference is allowed for more flexible installation.

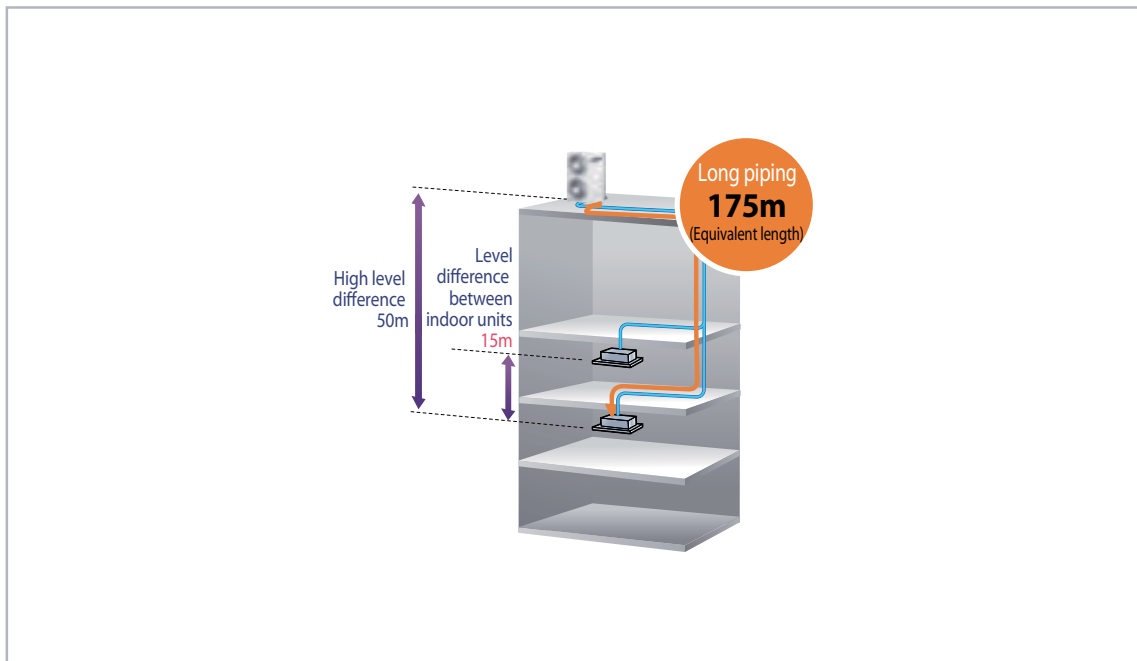

Feature (cont.)

■ Memory module

- Achieves world-class efficiency with hyper compressor that applies double compression technology

If outdoor unit malfunction occurs, diagnose and repair of the problem will be much quicker with the last 3 minutes worth of a data saved before the malfunction. (With the extra memory module, 3 months worth of a data can be saved.)

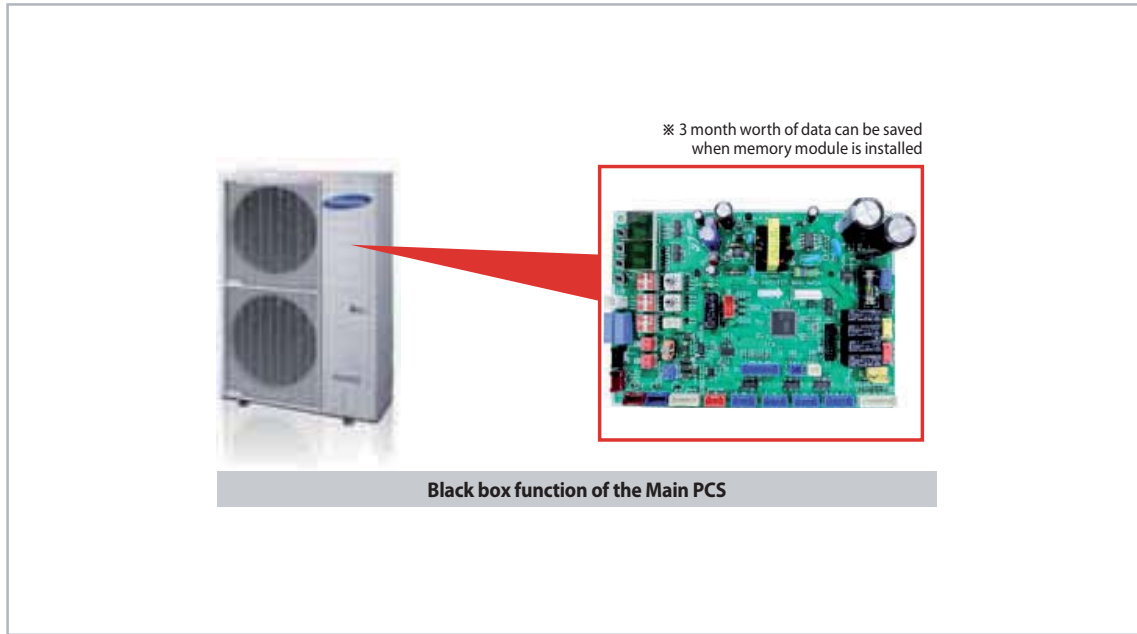

■ Silent operation at nighttime

- When outdoor unit needs to operate more silently during nighttime, silent mode can be set from the outdoor unit option mode.
- Silent mode can be adjusted in 3 levels depending on the level of noise.

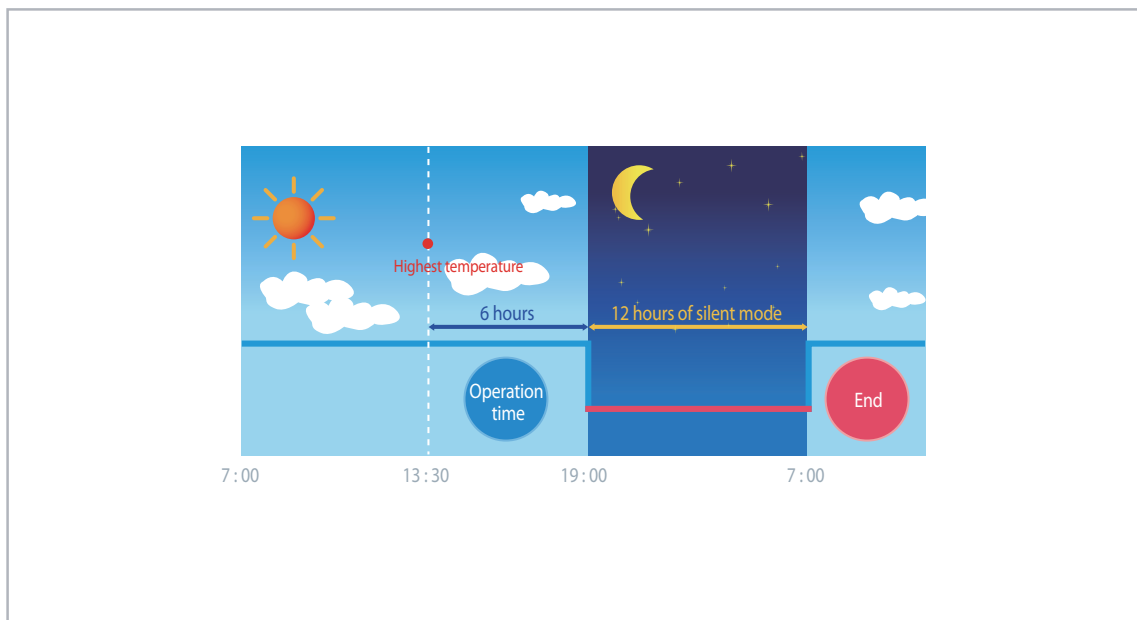

Feature (cont.)

■ Refrigerant pump-down

If you need to move/replace the outdoor unit or when there are problems on indoor units or on the pipes, outdoor unit will recover refrigerant remaining on the pipes.

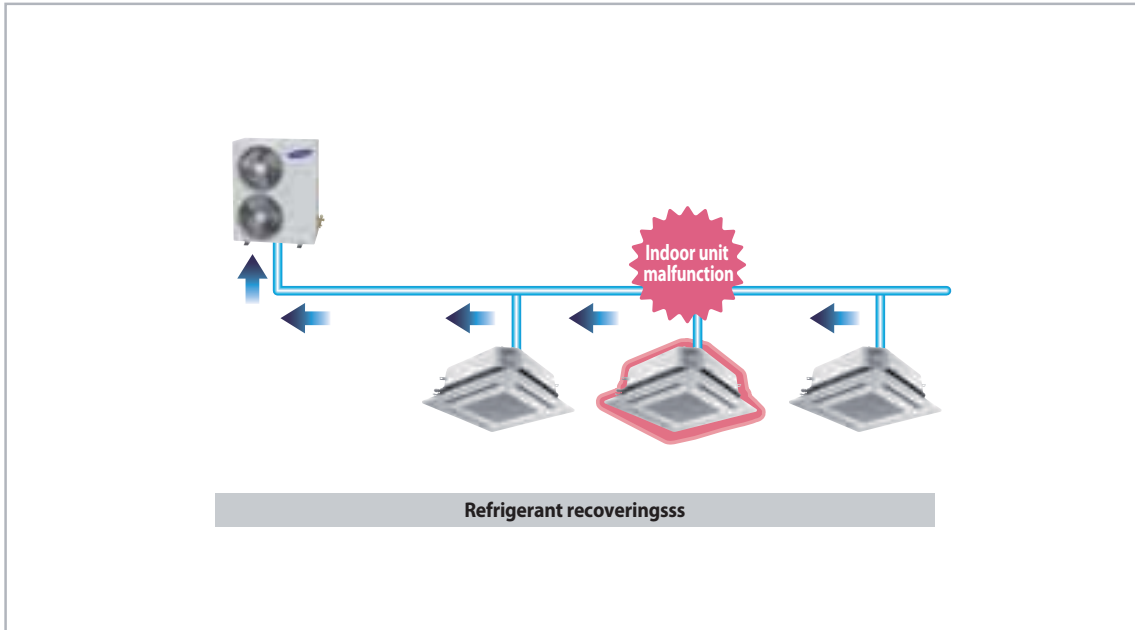

■ System check through View mode

- Through the window on outdoor unit PCB display, you can check the main system data during operation.
- Shortened maintaining and inspection
- Displaying 15 main data including high pressure of system
 - Outdoor temperature
 - Discharge temperature of the compressor
 - Condensing temperature
- Using the DIP switch on the outdoor unit PCB, you can limit the running current of the system

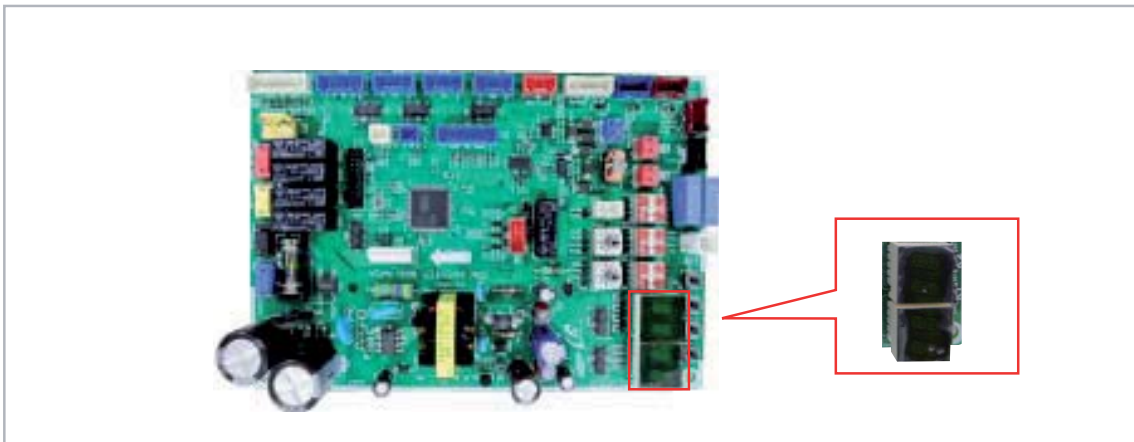

Feature (cont.)

■ Maximum 9 indoor unit connection

You may connect up to 9 indoor units on a single outdoor unit. It will allow more powerful and flexible air conditioning system and you can select refrigerant pipe length, or number of indoor units depending on the needs for office, commercial and residential places.

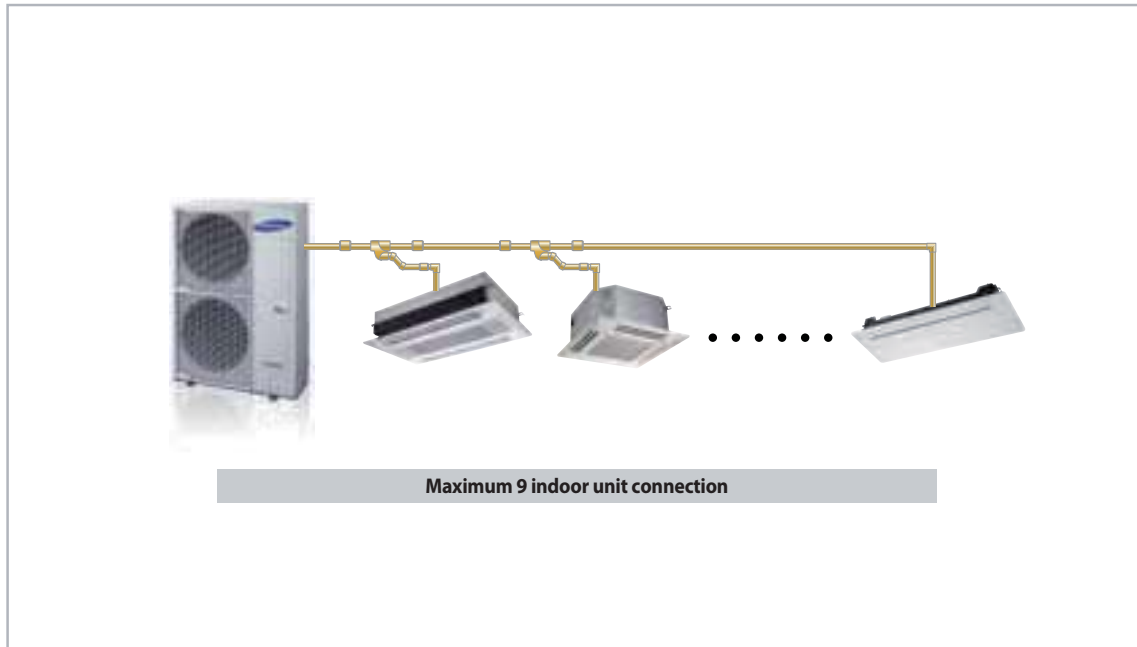

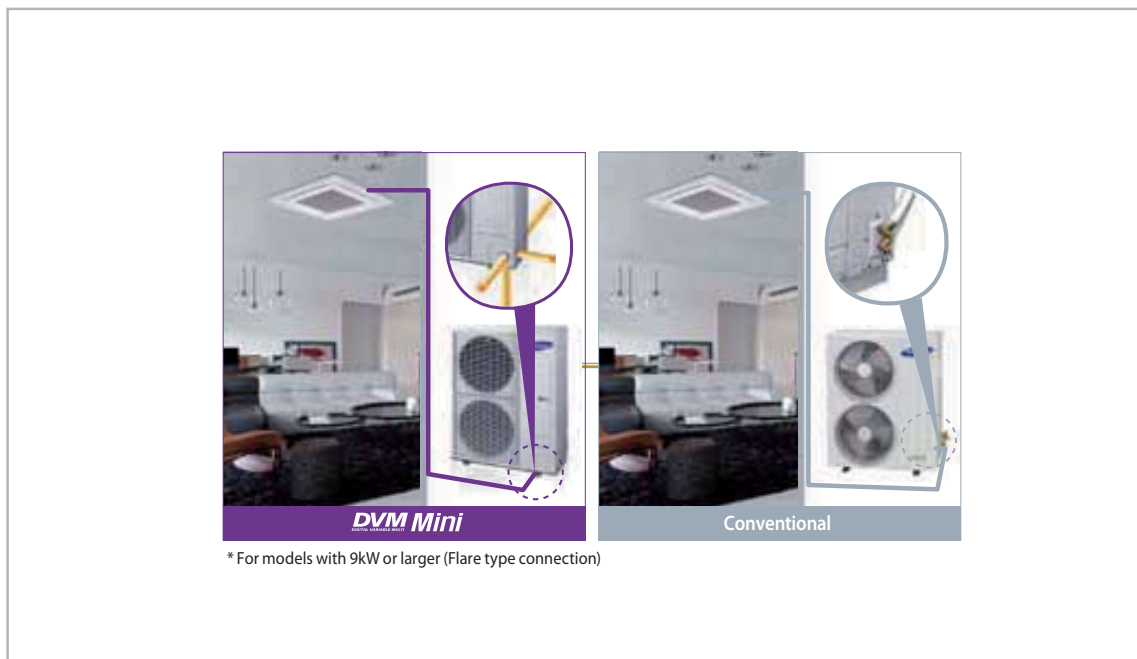

■ Convenient product installation

Service valve is not exposed to keep the neat appearance and pipe can be connected in 4 different directions which provide flexible installation and maintenance services.









2. Product Specifications

Type						
Performance		Btu/h	38,000	48,000	53,000	
Model			AM036FXMDCH	AM048FXMDCH	AM053FXMDCH	
Power Supply(Φ/V/Hz)			1, 208~230, 60	1, 208~230, 60	1, 208~230, 60	
Mode			HP	HP	HP	
Performance	Cooling	Btu/h	38,000	48,000	53,000	
	Heating	Btu/h	42,000	54,000	61,000	
	-10°C Heating	Btu/h	26,500	35,000	38,000	
Power	Running Current	Cooling*	A	15.2	20.7	24.7
		Heating*	A	18.1	23.2	26.6
	Input	Cooling*	W	3390	4700	5610
		Heating*	W	4100	5270	6060
	Power Breaker(MCCB/ELB)	A	4,100	5270	40	
Compressor	Type	-	Twin BLDC Inverter	Twin BLDC Inverter	Twin BLDC Inverter	
	Piston	cc/REV	43.0	43.0	43.0	
	Output	W	-	-	-	
	Lubricant	Type	-	POE	POE	POE
Charging		cc	1,700	1,700	1,700	
Refrigerant	Type	-	R410A	R410A	R410A	
	Factory Charging	kg	3.2	3.2	3.3	
FAN	Type	-	Propeller Fan	Propeller Fan	Propeller Fan	
	Motor Output	W	125x2	125x2	125x2	
	Airflow rate	CMM	95 (C) / 100 (H)	95 (C) / 100 (H)	95 (C) / 100 (H)	
Pipe	Piping connections	Liquid	ø,mm	9.52	9.52	9.52
		Gas	ø,mm	15.88	15.88	19.05
	Installation Limitation	Max. Length	M	300	300	300
		Length	M	150	150	150
Max. Height		M	50	50	50	
Cable	Main Power(Below/about 20m)	mm ²	CV 2.5/4.0	CV 2.5/4.0	CV 4.0/6.0	
	Communication	mm ²	VCTF 0.75~1.5	VCTF 0.75~1.5	VCTF 0.75~1.5	
Set Size	Net weight	Kg	100	100	103	
	Shipping Weight	Kg	105	105	108	
	Net dimension(WxHxD)	mm	940x1,210x330	940x1,210x330	940x1,210x330	
	Shipping dimension(WxHxD)	mm	995x1,338x426	995x1,338x426	995x1,338x426	
Operating Temp. Range	Cooling	°C	-5~48	-5~48	-5~48	
	Heating	°C	-20~26	-20~26	-20~26	
Maximum of connected indoor units			6	8	9	

* Rated Power/Current using Ducted indoor units

■ Disassembly and Reassembly

■ Necessary Tools



Item	Remark
+Screw Driver	
Monkey Spanner	
-Screw Driver	
Nipper	
Electric Motion Driver	
L-Wrench	

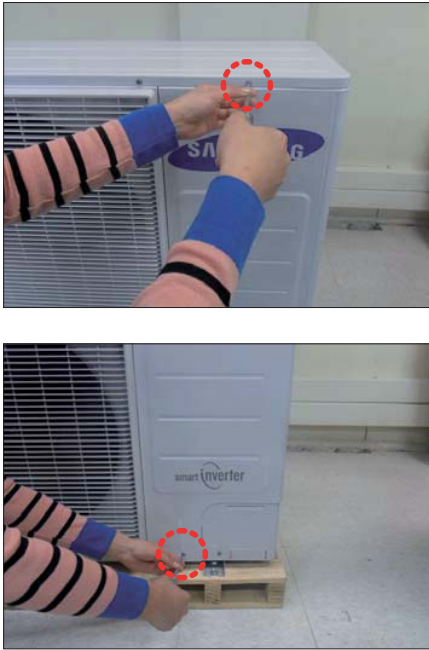
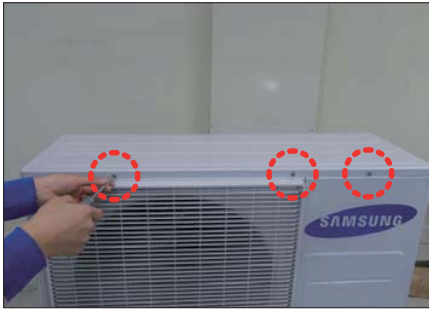
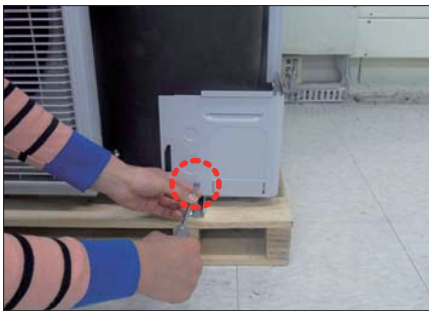

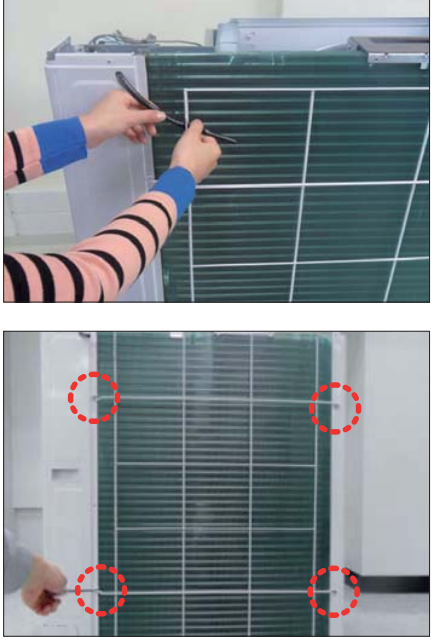
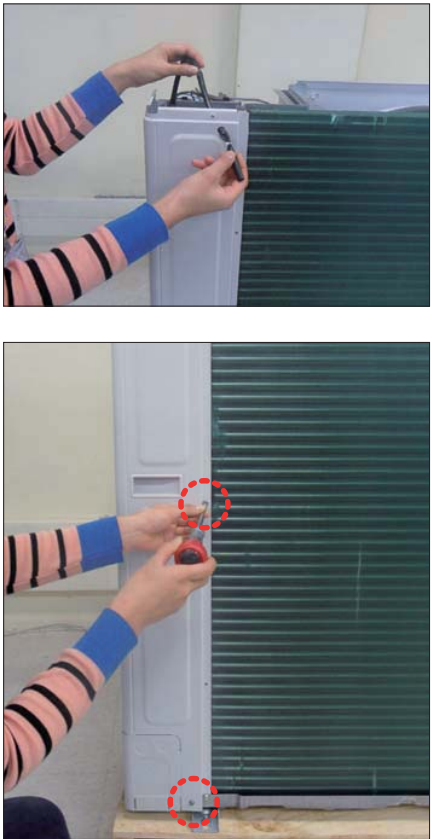
■ OUTDOOR UNIT

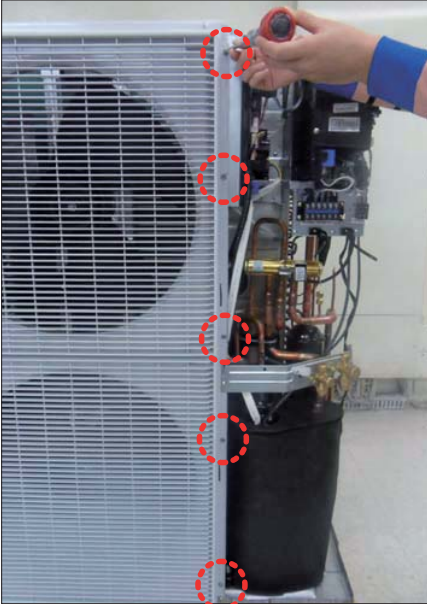
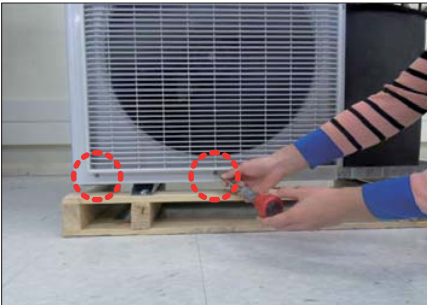
No	Parts	Procedure	Remark
1	Cabi Front RH	<p>⚠ You must turn off the Power before disassembly.</p> <p>1) Unscrew and remove 2 mounting screw in the Cabinet Front RH. (Use + Screw Driver)</p>	
2	Cabi Top	<p>1) Unscrew and remove 9 screws on each side of the Cabinet-Top. (Use +Screw Driver)</p>	
3	Cabi Install Front	<p>1) Unscrew and remove 1 screw in the Cabinet-Install Front. (Use +Screw Driver)</p>	



No	Parts	Procedure	Remark
4	Guard Cond	1) Pull the sensor from Guard Cond. 2) Unscrew and remove 4 screws in the Guard Cond. (Use + Screw Driver)	
5	Cabi Back RH	1) Pull the sensor from Cabi Back RH. 2) Unscrew and remove 4 screws on each side of the Cabinet Back RH. (Use + Screw Driver)	

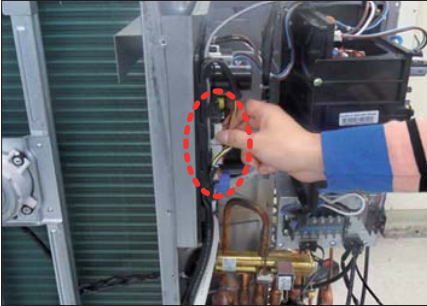

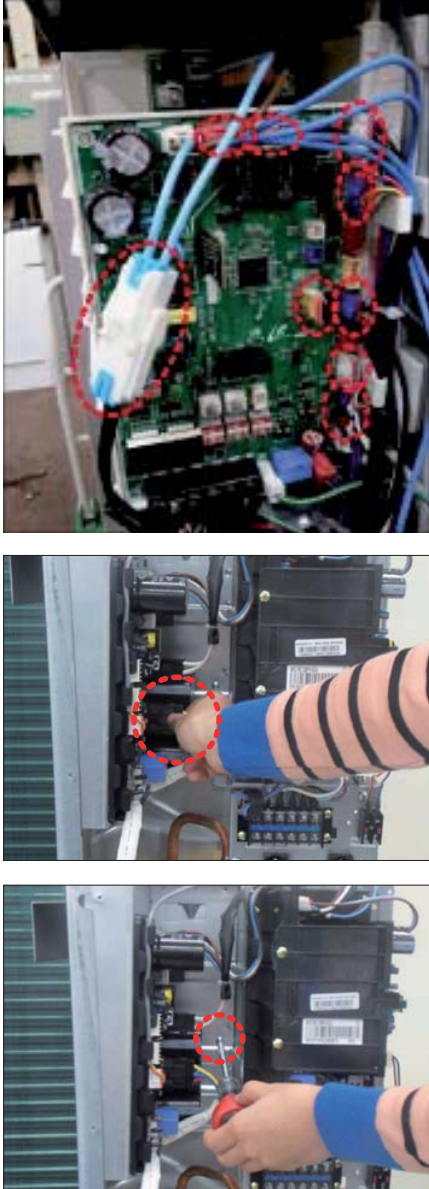

No	Parts	Procedure	Remark
6	Cabi Install Back	1) Unscrew and remove 1 screw in the Cabinet-Install Back. (Use +Screw Driver)	
7	Cabi Front LF	1) Unscrew and remove 10 screws in the Cabinet-Front LF. (Use +Screw Driver)	 

No	Parts	Procedure	Remark
			
8	Fan	<p>1) Turn 2 mounting nuts as shown in the picture and remove it. (Use L Wrench or Monkey Spanner or Socket Wrench)</p>	

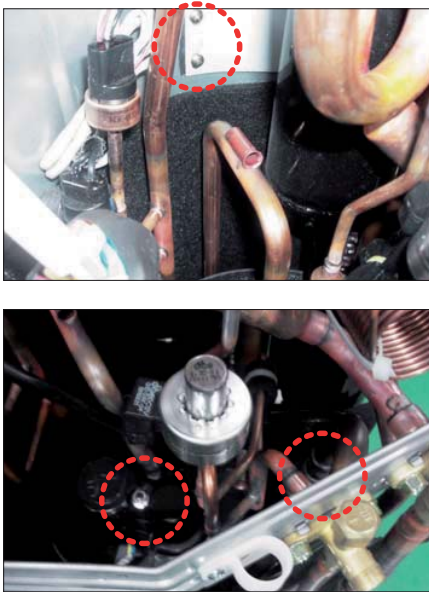
No	Parts	Procedure	Remark
9	Motor	1) Separate the Fan Propeller. 2) Unscrew and remove the 8 Motor mounting screws. (Use +Screw Driver) 3) Disconnect the Motor wire from Ass'y Control Out.	 
10	Bracket Motor	1) Unscrew and remove 2 mounting screws in Bracket Motor. (Use + Screw Driver)	

No	Parts	Procedure	Remark
11	Control Out	<p>1) Disconnect 9 Connectors from Ass'y control Out.</p> <p>2) Unscrew and remove 1 mounting screw in Control Out. (Use + Screw Driver.)</p> <p>3) Separate Ass'y Control Out.</p>	

No	Parts	Procedure	Remark
12	Ass'y Tube EEV	1) Purge the Coolant first. 2) Separate 2 parts of the pipe using a welder. ⚠ When removing the compressor, Heat Exchanger and Pipe, purge the refrigerant inside the Compressor completely and remove the pipe with a welding flame.	
13	Ass'y Tube Suction	1) Separate 2 parts of the pipe using a welder.	
14	Ass'y Tube 4Way	1) Unscrew and remove 2 mounting screws in Oil Separator. (Use + Screw Driver.) 2) Separate 2 parts of the pipe using a welder.	

No	Parts	Procedure	Remark
13	Compressor	<p>1) Unscrew and remove 1 mounting nut in bottom of the cover. (Use Adjustable Wrench)</p> <p>2) Separate the Compressor Felt.</p> <p>3) As shown in the picture, unscrew and remove 3 mounting screws from the bottom. (Use L-Wrench or Monkey Spanner or Socket Wrench)</p>	    

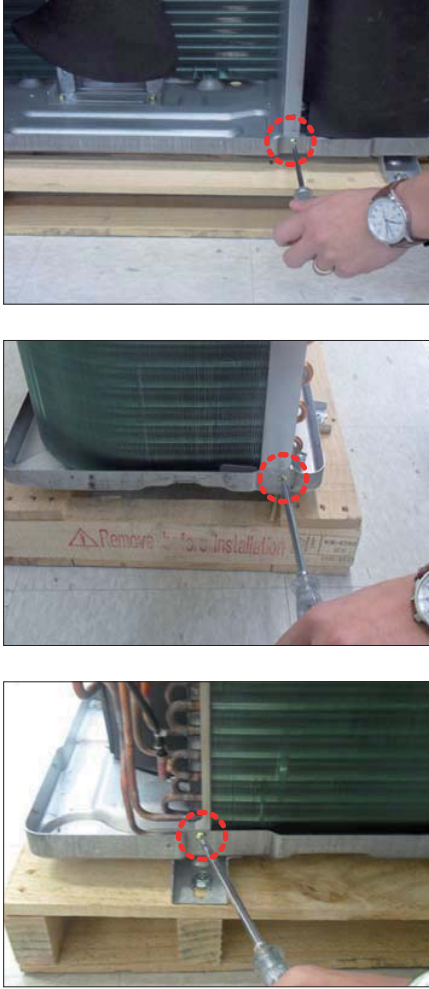
No	Parts	Procedure	Remark
16	Cond Out	1) Unscrew and remove 3 screws on each side of the Ass'y Cond Out. (Use + Screw Driver)	

■ Troubleshooting

1. Error Display



2. Error Code

No.	Code	Description
1	E201	Communication error between indoor and outdoor unit (Tracking failure or the setting quantity/address of indoor unit in outdoor unit's PCB differs from the quantity/address of installed indoor unit.)
2	E202	Communication error between indoor and outdoor unit. (All the indoor communication error, outdoor communication cable error.)
3	E203	Communication error between main and sub micom or communication error between main and sub outdoor units.
4	E221	Error on ambient temperature sensor of outdoor unit. (Open or Short)
5	E251	Error on discharge temperature sensor of compressor. (Open or Short)
6	E231	Error on Cond-out temperature sensor of outdoor unit. (Open or Short)
7	E291	High pressure sensor error (Open/Short)
8	E296	Low pressure sensor error (Open/Short)
9	E308	Suction sensor error (Open/Short)
10	E311	Double tube sensor error (Open/Short)
11	E403	Antifreeze error
12	E407	Compressor stop by high pressure protection control
13	E410	Compressor stop by low pressure protection control
14	E416	Compressor stop by discharge temperature protection control
15	E419	EEV open error
16	E425	Reverse phase detection error
17	E438	EVI EEV open error
18	E439	Refrigerant leakage error (during stop status)
19	E440	Prohibition of heating operation when the ambient temperature is over 30°C
20	E441	Prohibition of cooling operation when the ambient temperature is below -15°C
21	E443	Refrigerant leakage error (during operation)
22	E458	Outdoor fan 1 error
23	E460	Power or voltage in connection wire between indoor-outdoor unit
24	E461	Compressor starting error
25	E462	Total current protection control, compressor stops
26	E463	OLP temperature control, compressor stops
27	E464	IPM over current error
28	E465	Compressor overload error
29	E466	DC-Link voltage under/over error
30	E467	Compressor rotation error
31	E468	Current sensor error
32	E469	DC LINK voltage sensor error
33	E470	EEPROM read/write error
34	E471	EEPROM unmatching error
35	E474	Heat sink temperature error
36	E475	Outdoor fan 2 error
37	E484	PFC overload
38	E485	Input current sensor error
39	E500	Heat sink overheat
40	E554	Gas leak error

3. How to take measures for each symptom

3-1 Communication error between indoor and outdoor units during tracking (Error Code : E201)

1. How to check

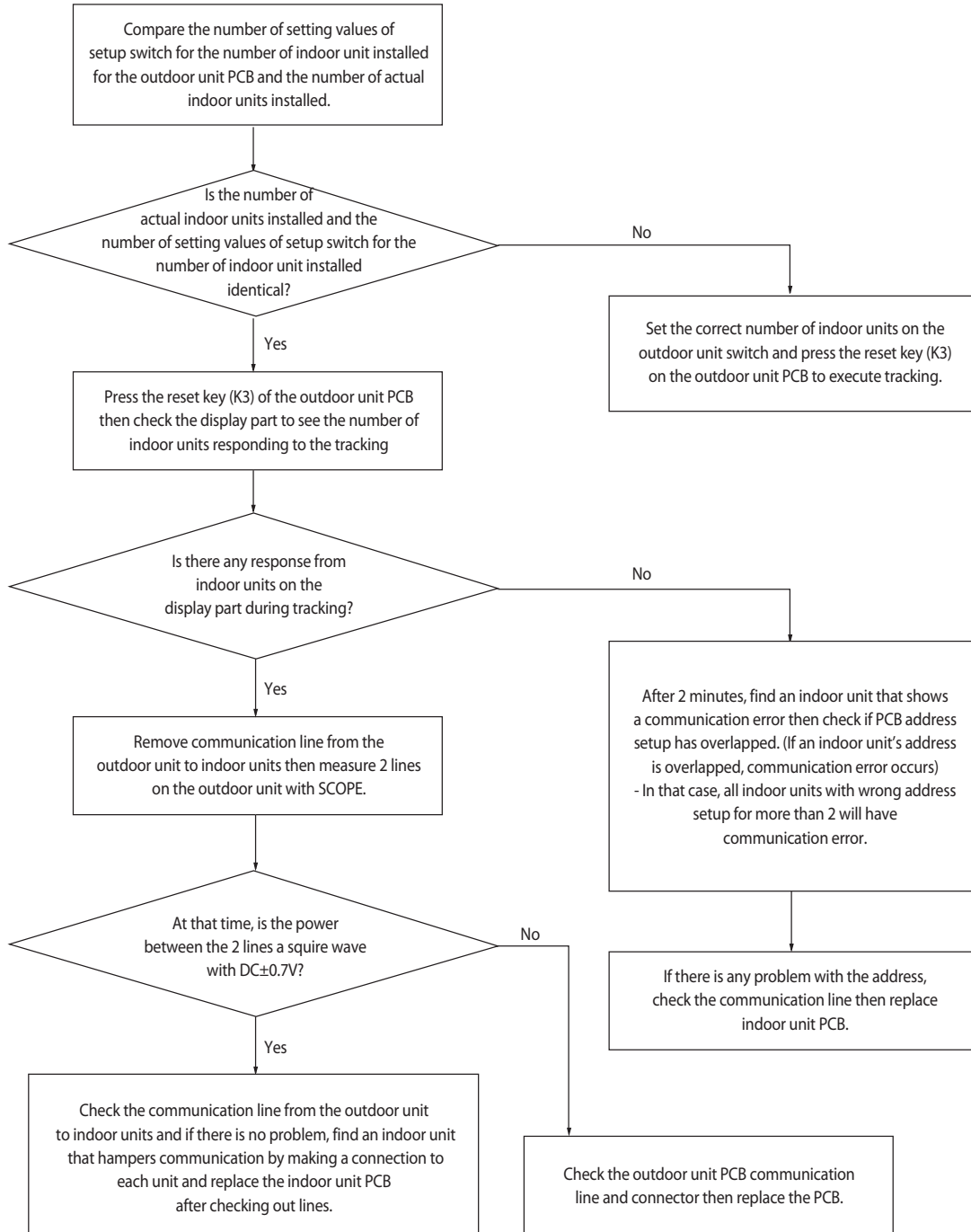

3-2 Communication error between indoor and outdoor units after completing tracking (Error Code : E202)

1. How to check

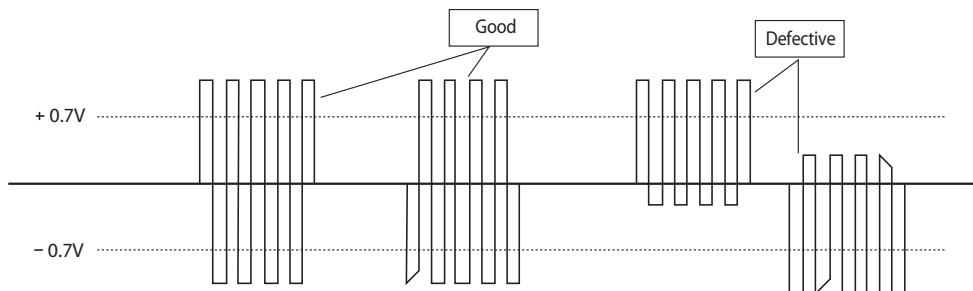
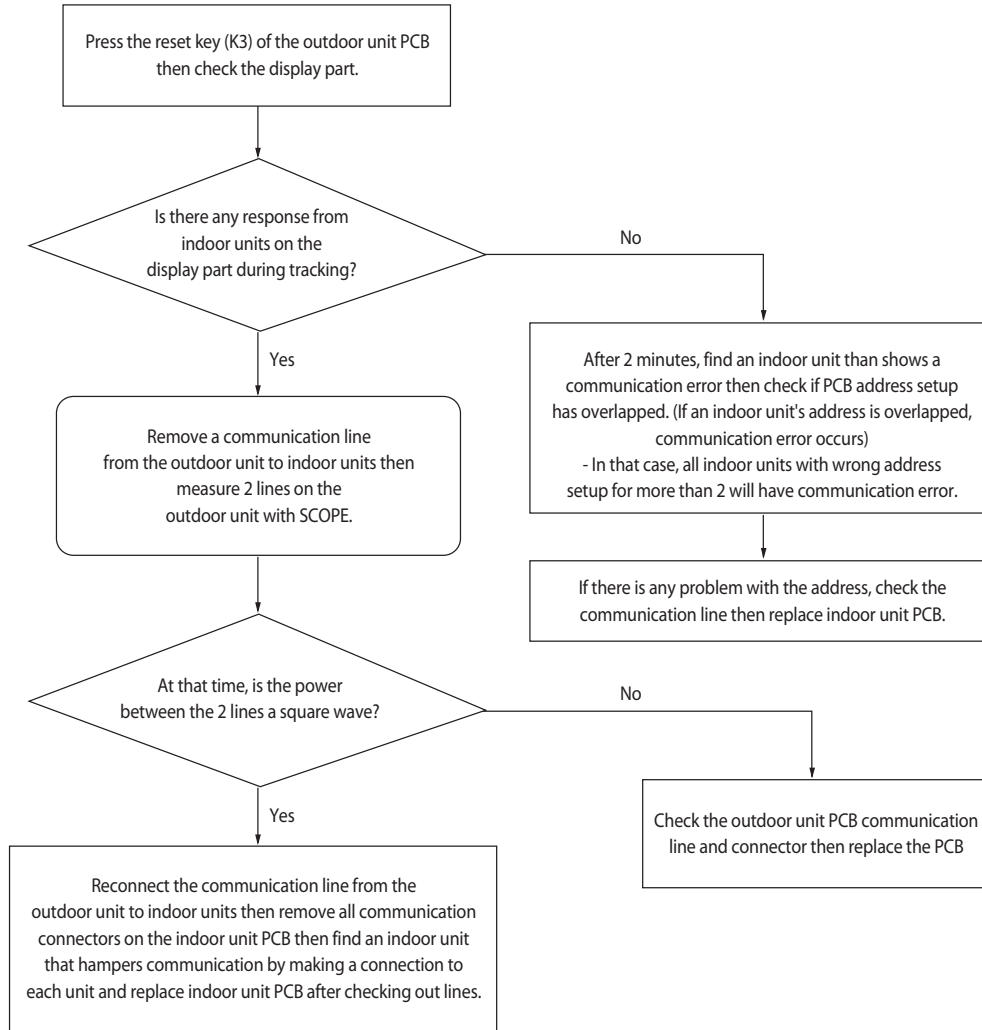

3-3 Communication error (1 minute) between Main and Sub Micoms of an Outdoor unit or among Outdoor Units (Error Code : E203)

1. Check items
 - 1) Is there power on outdoor unit inverter PBA?
 - 2) Connect the power cable/check the fuse
 - 3) Is there any problem on communication cable between outdoor unit inverter (CN31) ↔ Main PBA (CN39)?
 - 4) Check the communication cable connection
2. Check procedure

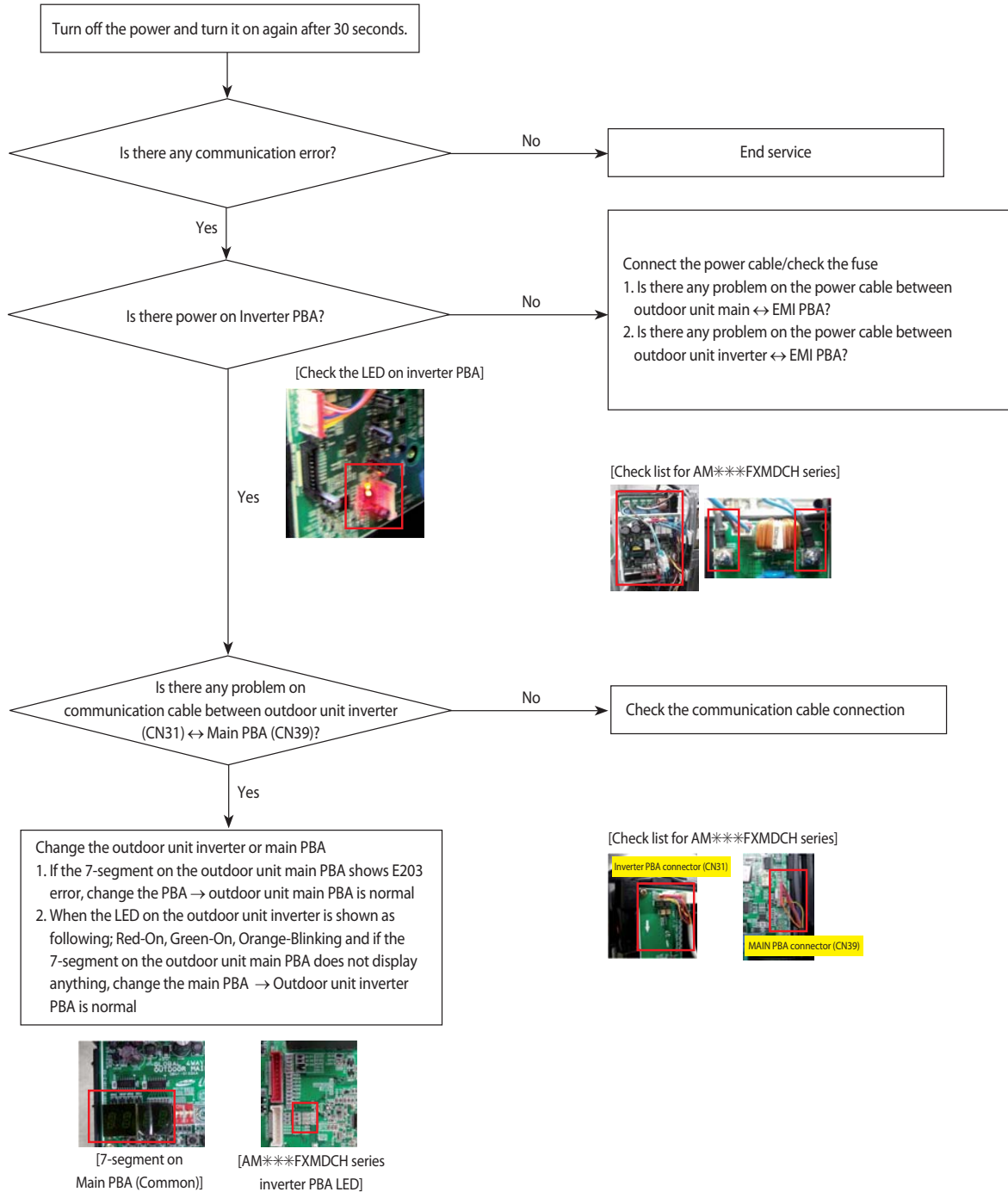

3-4 Outdoor temperature sensor error (Error Code : E221, E231, E251, E269)

1. Check items

- 1) Check the temperature sensor connector
- 2) Check the resistance value of outdWoor temperature
- 3) When E221 occurs, please recheck display two minutes later.

Error code	Error explanation	Error code	Error explanation
E221	Outdoor unit temperature sensor Error	E320	Indoor unit OLP sensor Error
E231	Outdoor unit COND.sensor Error	E308	Suction temperature sensor error
E251	Outdoor unit discharge sensor Error	E311	Double tube temperature sensor error

If E221 is displayed two minutes later, please follow the below check produre.

If E441 is displayed two minutes later, please follow E441 check produre.

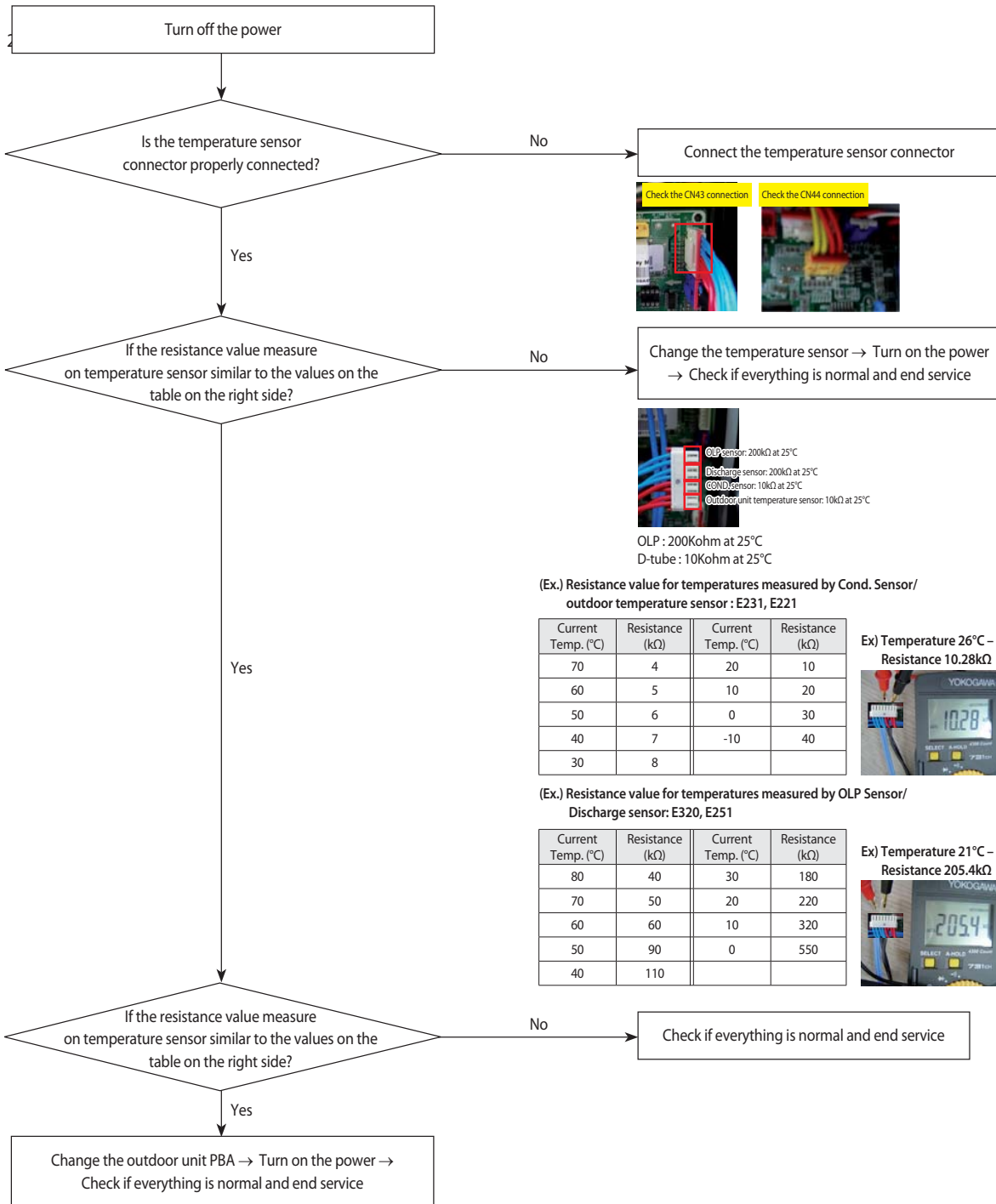

3-5 High pressure temperature sensor error (Open/Short) (Error Code : E291) Low pressure temperature sensor error (Open/Short) (Error Code : E296)

1. High/low pressure sensor OPEN/SHORT error determination method
 - 1) Identifies from when power is supplied or 2 minutes after RESET, and only when set is stopped.
 - 2) An OPEN/SHORT error will occur if the input voltage standard exceeds 0.5V ~ 4.95V range
2. How to check

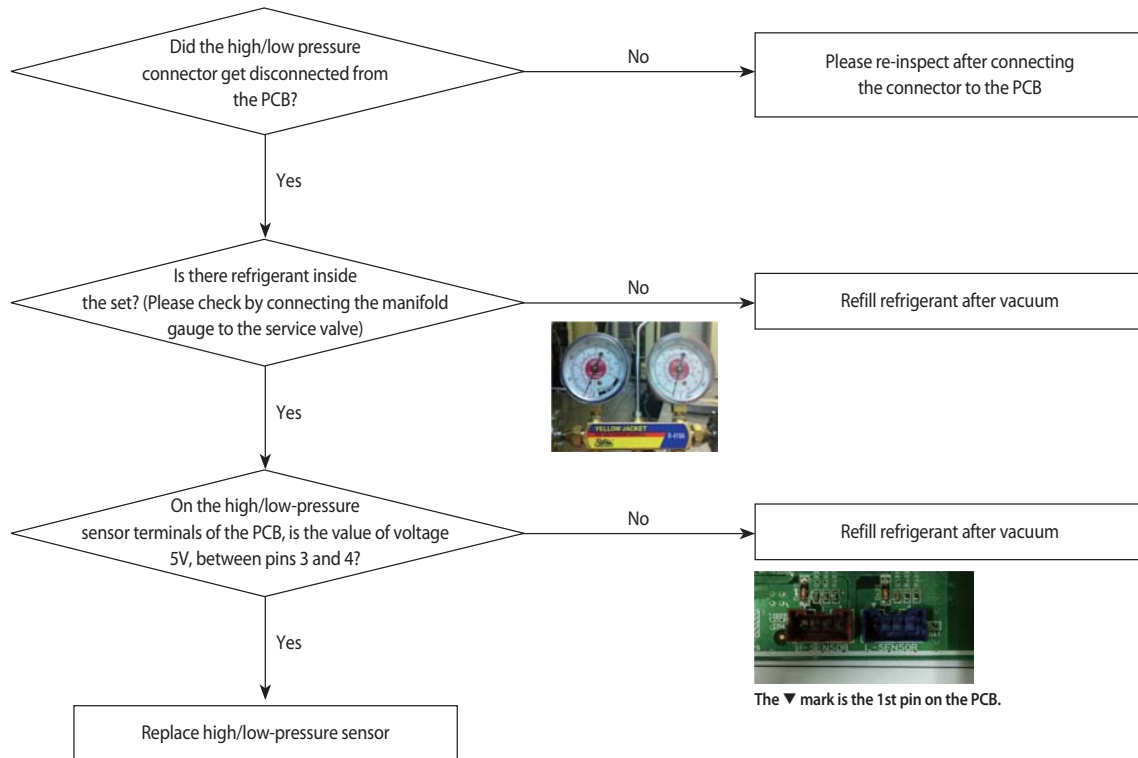

3-6 Compressor down by antifreeze control (Error Code: E403)

1. Check items

- 1) Check if the indoor fan/motor is working properly
- 2) Check if the indoor EEV is working properly
- 3) Check the indoor heat exchanger IN/OUT sensor
- 4) Check if the indoor air inlet blocked

2. How to check

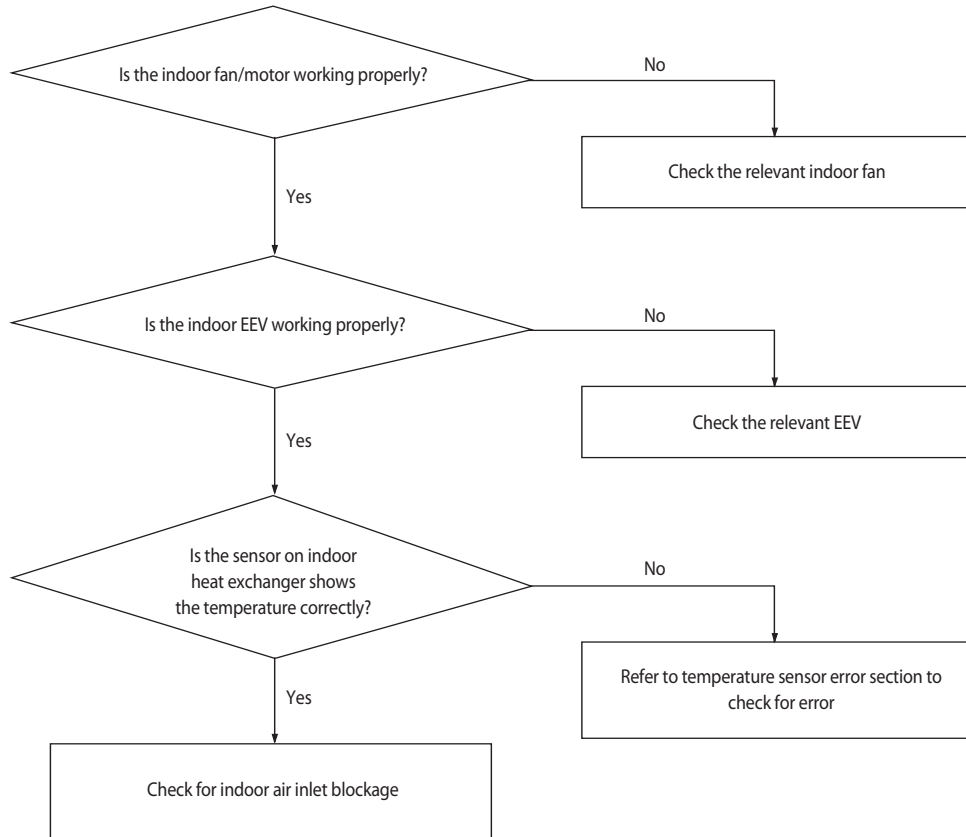

3-7 Comp. down due to a protective control of high pressure (Error Code : E407)

1. How to check

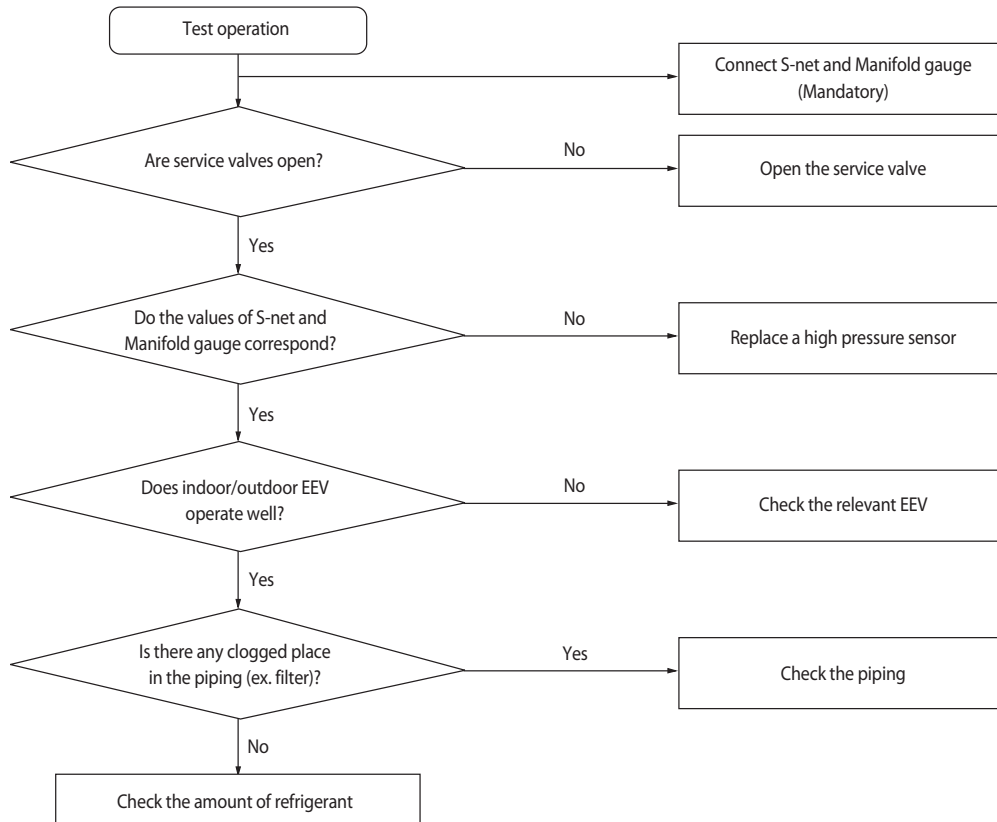

3-8 Comp. down due to a protective control of low pressure (Error Code : E410)

1. How to check

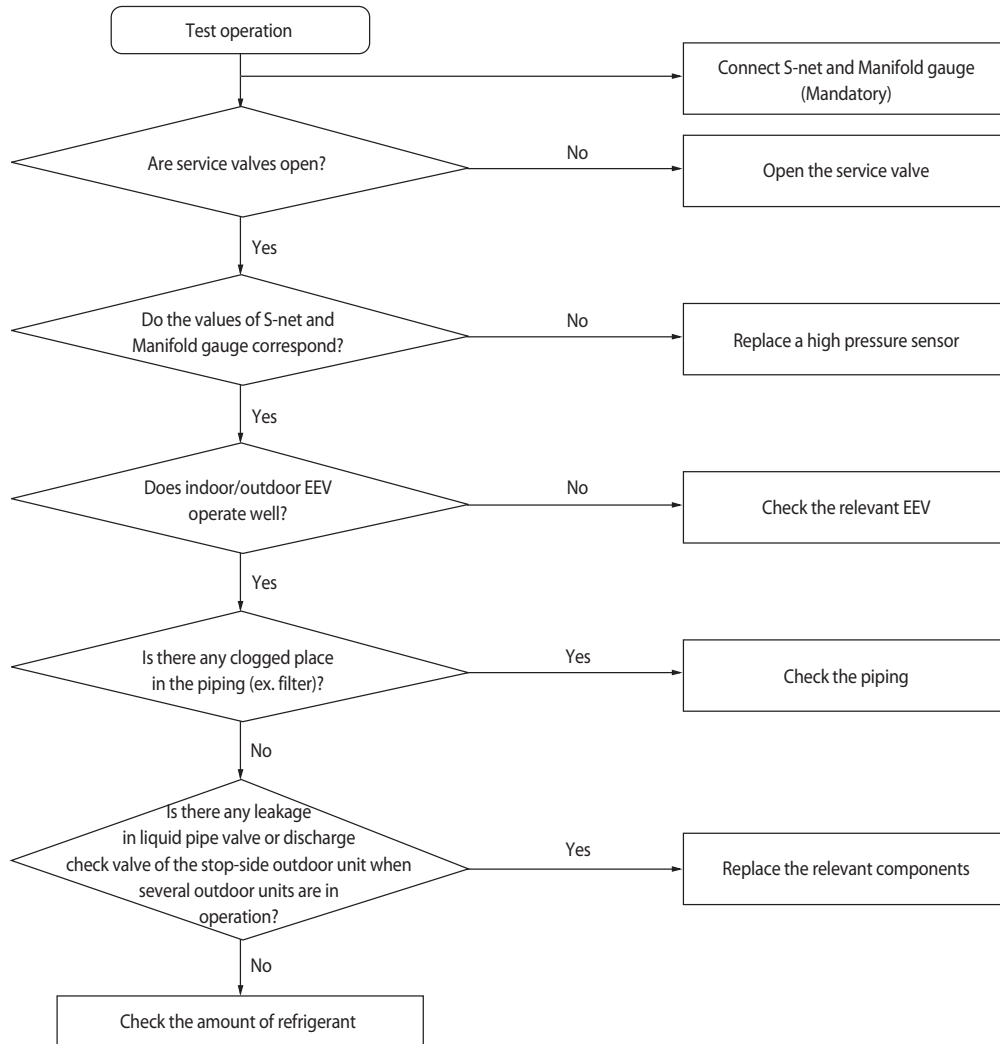

3-9 Comp. down due to a discharge temperature sensor of a compressor (Error Code : E416)

1. How to check

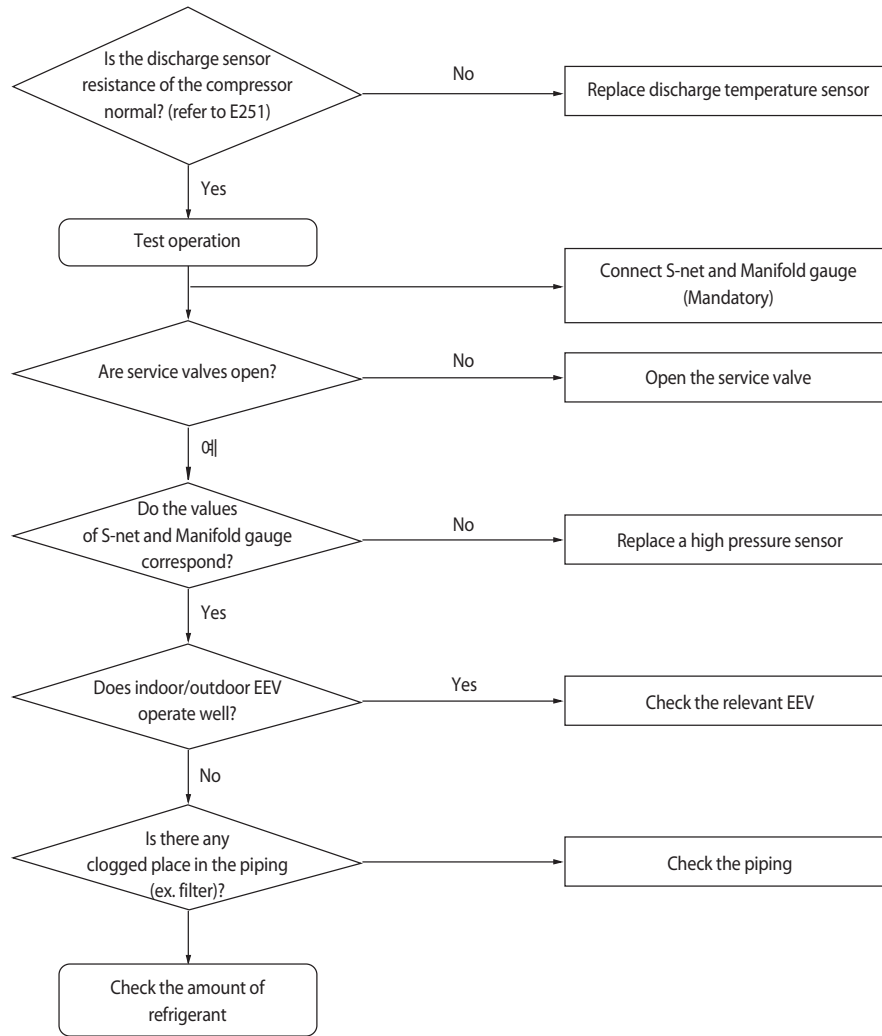

3-10 Reverse phase detection error (3Phase outdoor unit) (Error Code : E425)

1. When power is on, it checks the power status used for 3-phase power compressor.

When the order of 3-phase L1(R) – L2(S) – L3(T) is changed (reversed) or there is a phase that does not receive power (phase fail), it will display [E425] and the air conditioner will stop operating.

1) Check the voltage on L1(R) – L2(S) phase/ L1(R) – L3(T) phase/ L2(S) – L3(T) phase.

2) When there is any terminal that does not have normal voltage, check the external power of the air conditioner and take appropriate measures.

3) If 3-phase power is normal check the phase of the power line using 3-phase tester. If it shows reverse phase, please change the current power line connection.

4) After completing above, press reset key (K3) then check the power again.

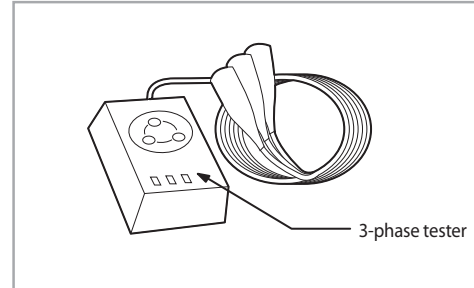

3-11 ESC EEV open error (Error Code : E438)

1. How to check

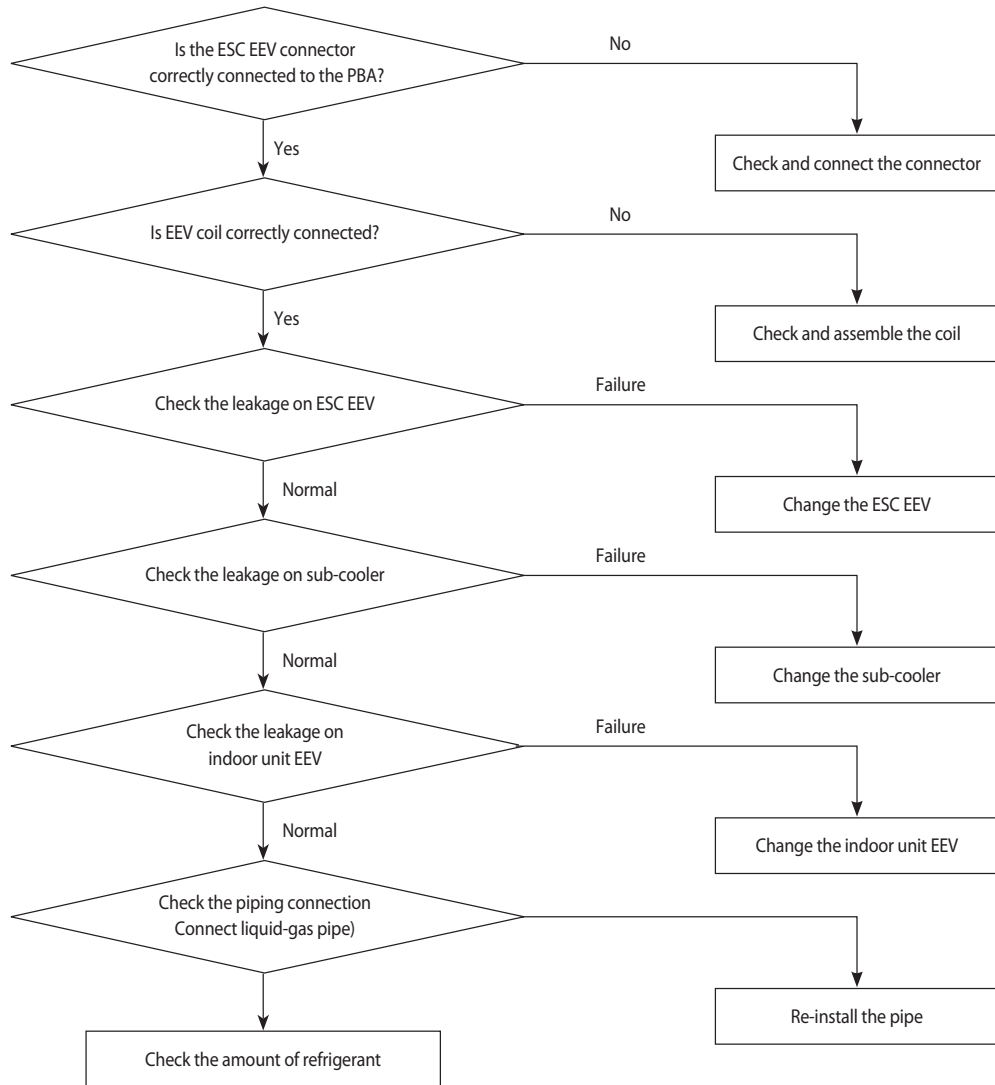

3-12 Refrigerant leakage error (Error Code : E439)

1. Determining high/low-pressure sensor OPEN/SHORT error

- 1) Identifies from when power is supplied or 2 minutes after RESET, and only when set is stopped.
- 2) An E439 error will occur if the input voltage standard ranges of 0.5V ~ 4.95V of both the high- and low-pressure sensors are exceeded.
- 3) Will occur if the measured value of both high/low-pressure sensors is 1kgf/cm2G

2. How to check

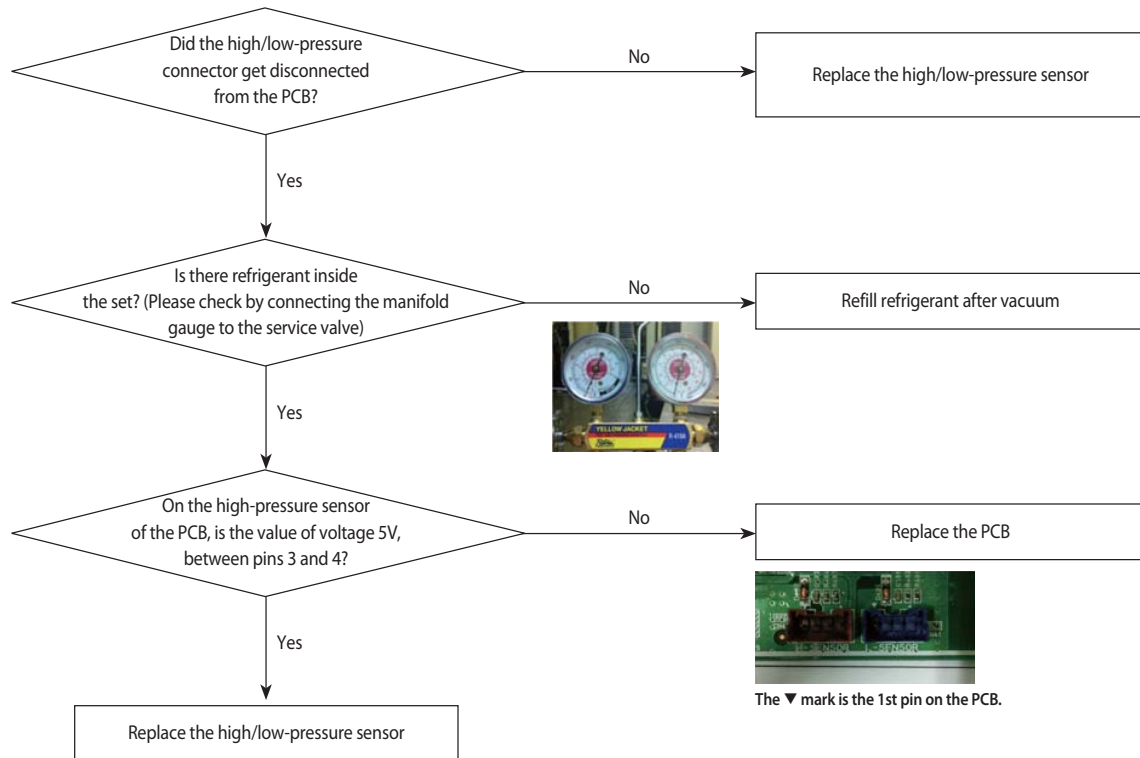

3-13 Prohibition of the compressor operation due to outdoor temperature (Error Code : E440, 441)

1. How to check

The above error code is not caused by a product's problem but a function to protect the product by limiting the available temperature range so please refer to the usable temperature range in the product manual.

If the error code is displayed despite a condition that does not belong to any of the above diagnosis methods, read the temperature sensor value of the outdoor inlet air with View Mode or S-net, and if the actual outdoor temperature is different, please replace the temperature sensor.

3-14 Refrigerant leakage error (during operation) (Error Code : E443)

1. How to check

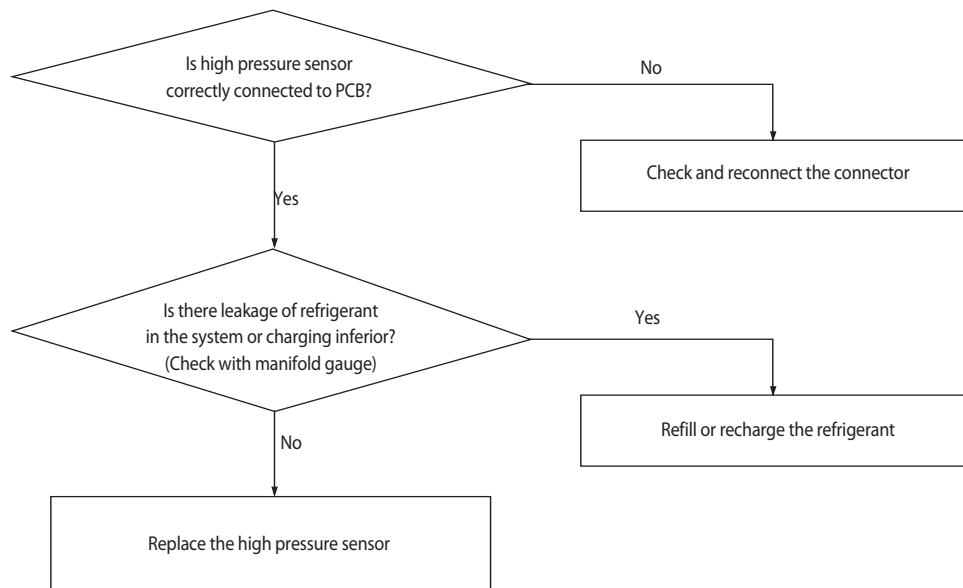

3-15 Outdoor unit fan error (Error Code : E458, 475)

1. Check items

- 1) Check the connection of the fan connector (CN90, CN 91)
- 2) Check the voltage of the fan motor connector on outdoor unit inverter PBA
- 3) Check the power connection on outdoor unit inverter PBA
- 4) Check the fan motor (Motor connector must be disconnected after 30 seconds from power off)
- 5) For models with single fan, connector must be connected to CN90 (Fan2 error will not occur)

2. Check procedure

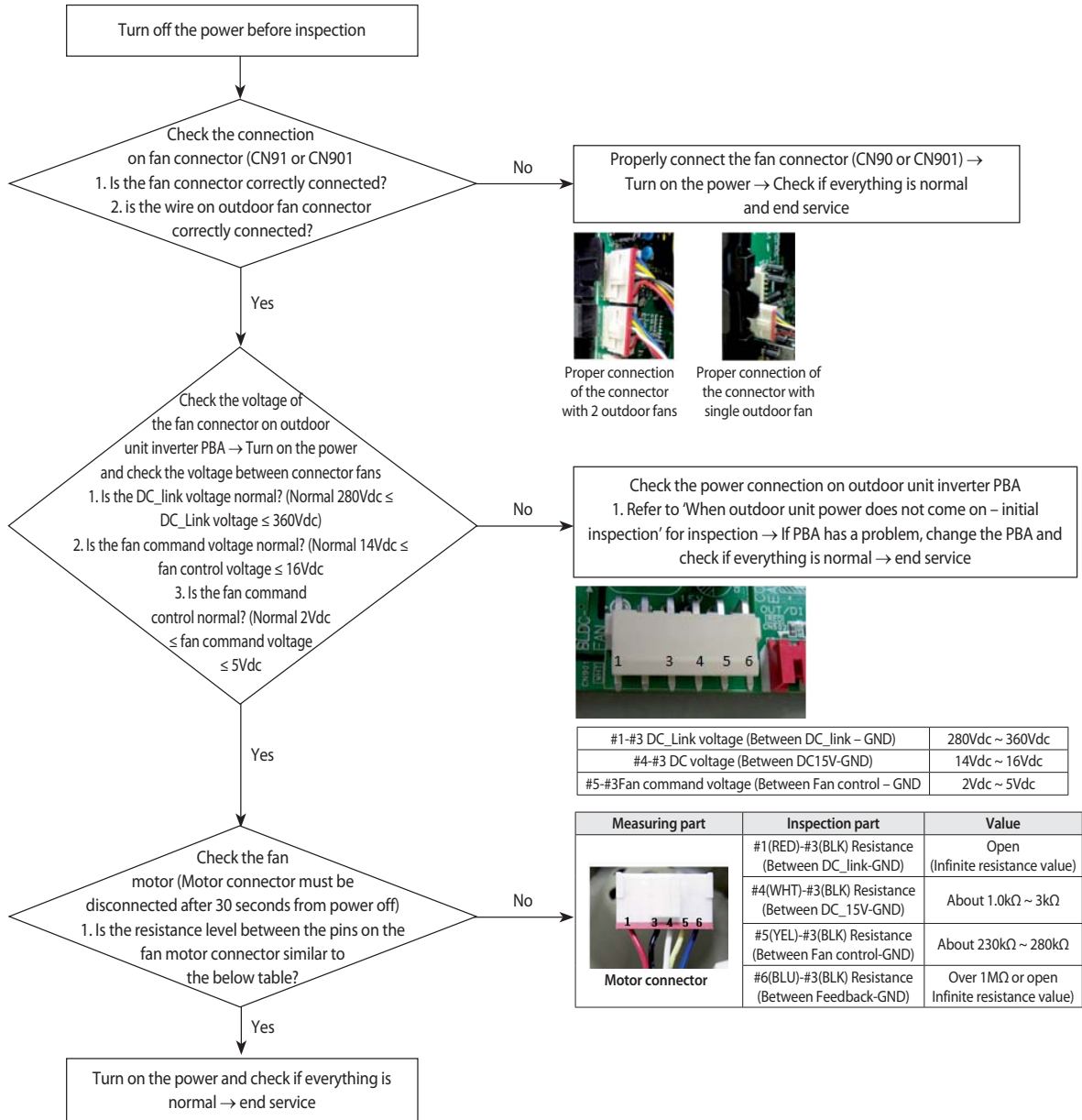

* When connecting/disconnecting the fan motor connector, you must wait for 30 seconds after turning off the power -> If not, motor or PBA can get damaged

* You must check the inverter PBA or fan motor and replace them only when they have problem

* Do not change the outdoor unit PBA with fan motor problem

→ If the 7-segment on the outdoor unit main PBA shows error, there is no problem with outdoor unit main PBA

→ Control related problems can be solved by S/W update

3-16 Comp down due to OLP temperature control (Error Code : E463)

1. How to check

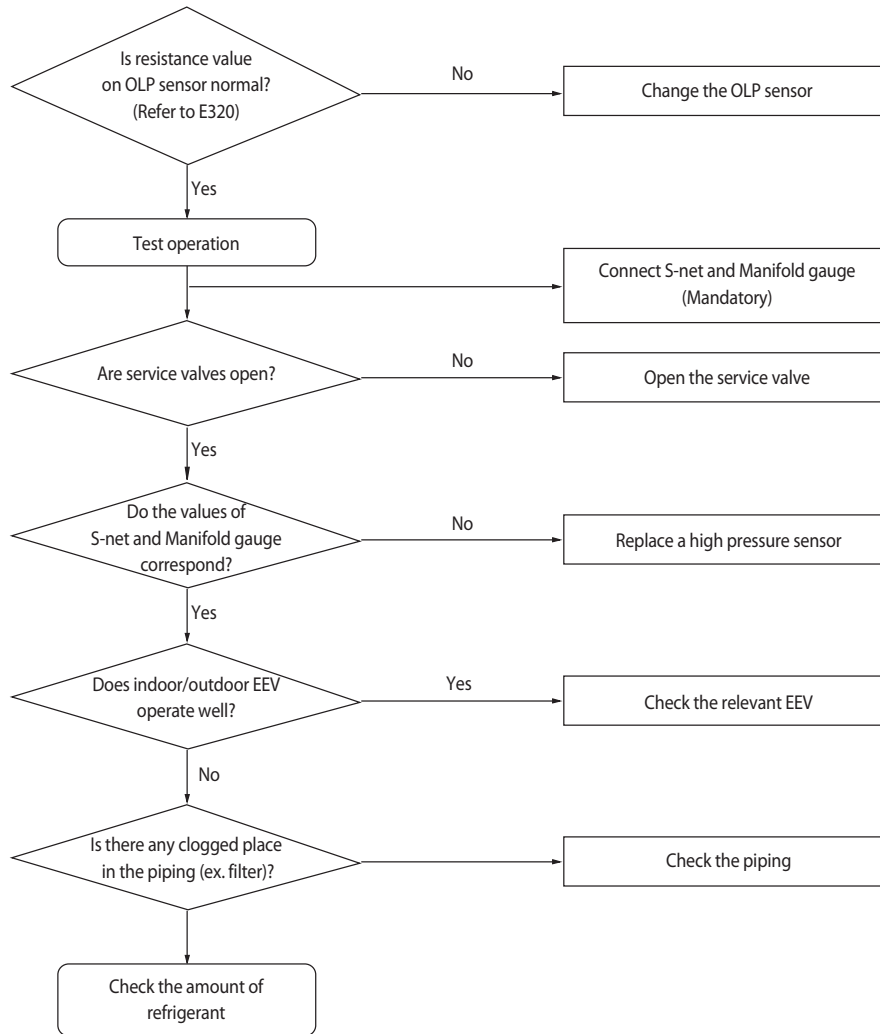

3-17 Compressor starting/rotation error (Error Code : E461, E467)

1. Check items
 - 1) Check the power and restarting after power reset
 - 2) Check for compressor and compressor wire assembly
 - 3) Check for compressor wire problem
2. Check procedure

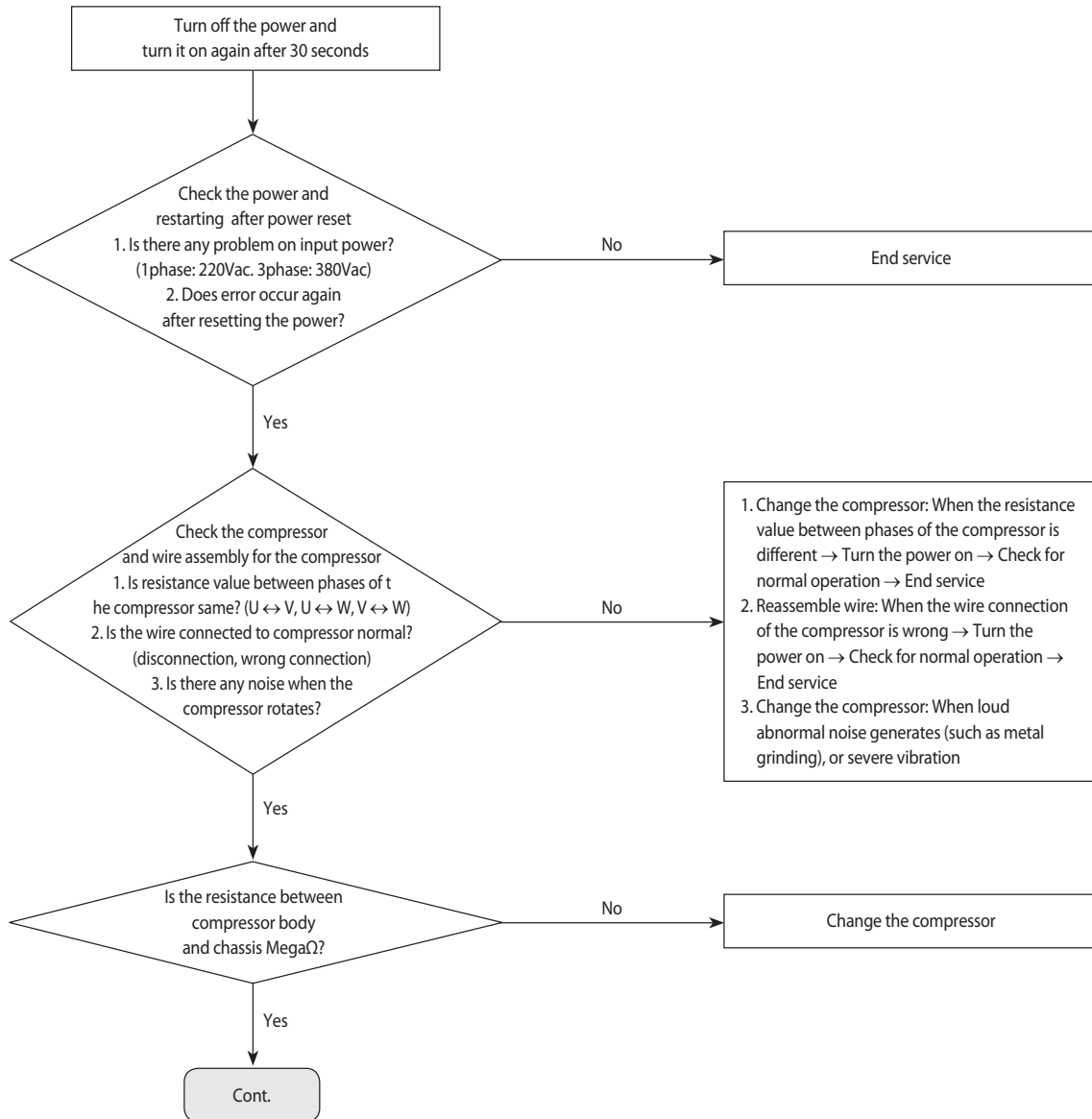

Compressor starting/rotation error (Error Code : E461, E467) (cont.)

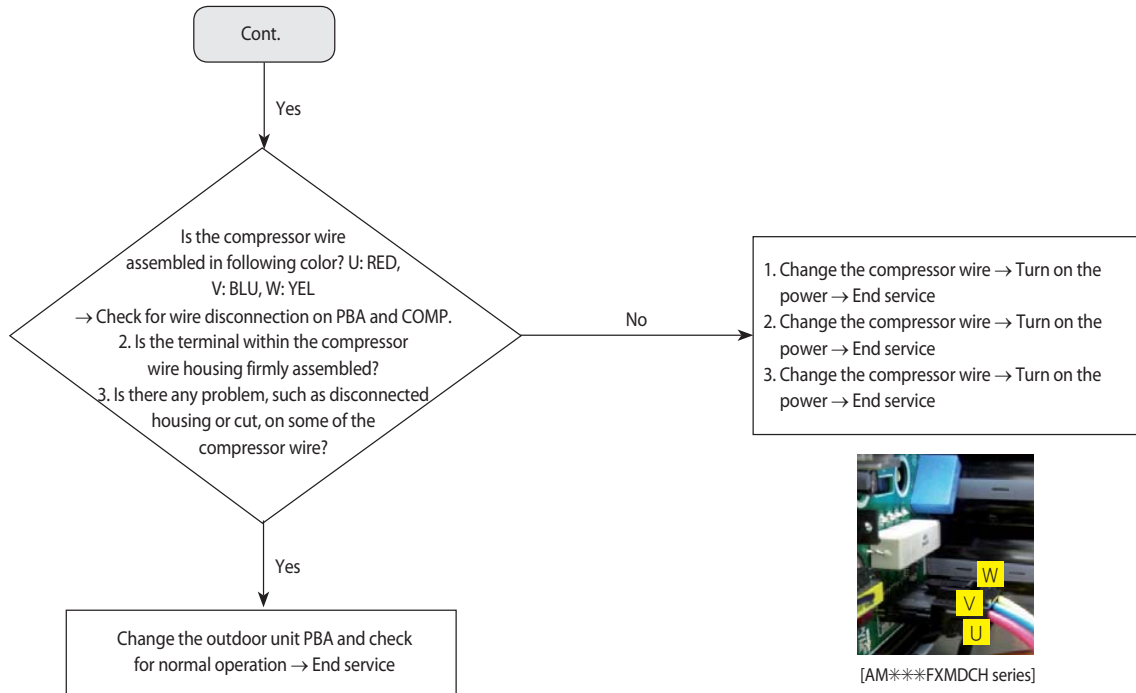

- * Do not change the EMI/outdoor unit main/ Indoor unit main PBA when E461, E467 error occurs
→ It is Compressor, inverter PBA related error, therefore it is not related to above PBA
- * Make sure to check if service valve is open
→ If the service valve is close, damage could occur due to pressure difference during operation

3-18 Current error / PFC overload error (Error Code : E462, E484)

1. Check items

- 1) Check the power and restarting after power reset
- 2) Check the outdoor unit installation and environments
→ Check if the outdoor unit inverter PBA related wires are disconnected. Check the installation environment
- 3) Check for indoor unit installation environment
- 4) Check for open service valve

Error CODE	Error description	Related model
E462	Outdoor unit total current error	AM***FXMDCH series
E484	Outdoor unit PFC overload error	AM***FXMDCH series

2. Check procedure

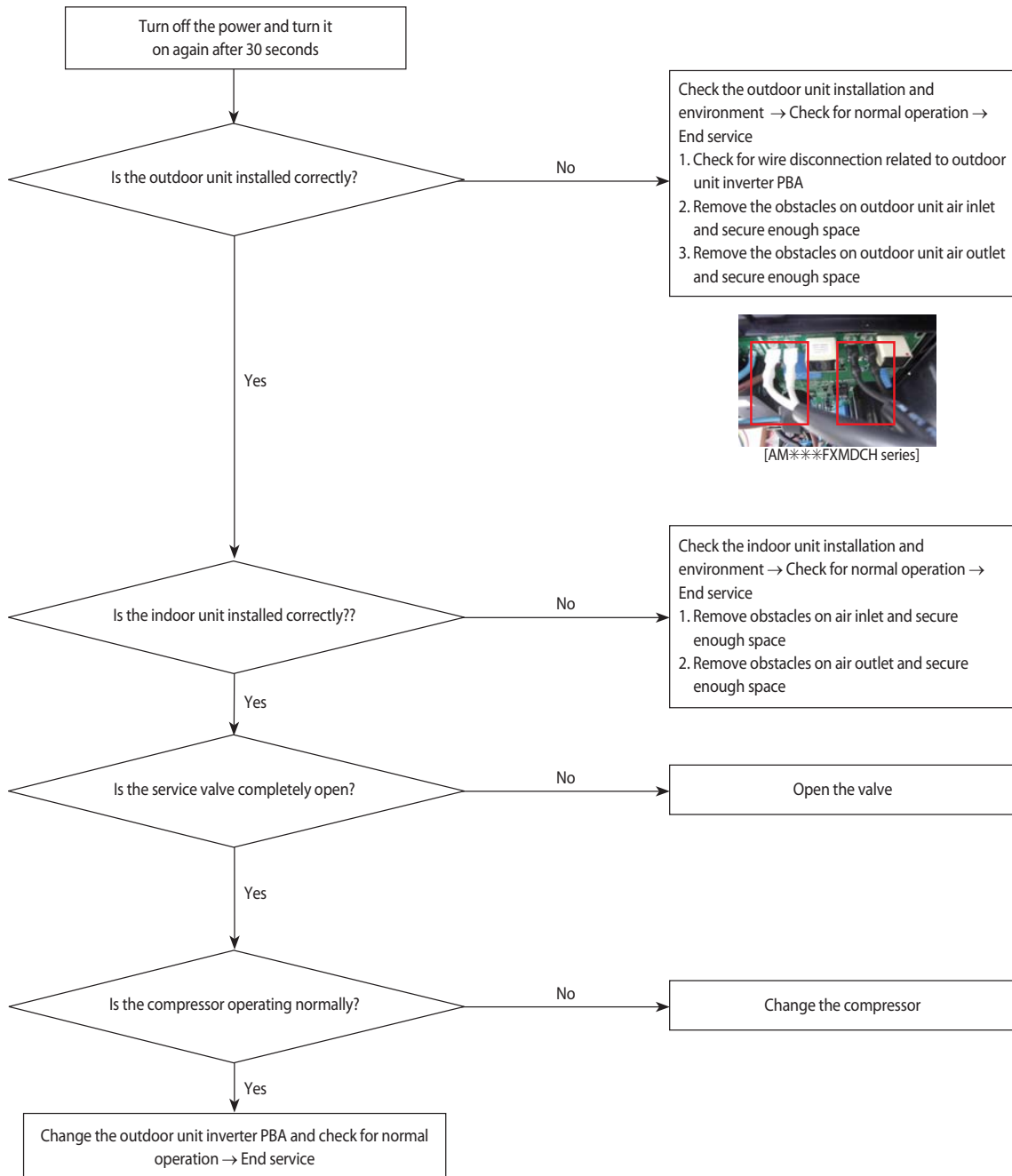

3-19 IPM over current error (Error Code : E464)

1. Check items

- 1) Check the power and restarting after power reset
- 2) Check the outdoor unit installation and environments
→ Check if the outdoor unit inverter PBA related wires are disconnected. Check the installation environment
- 3) Check for indoor unit installation environment
- 4) Check for open service valve
- 5) Check the assembly status of the compressor and compressor wire
- 6) Check the compressor wire

2. Check procedure

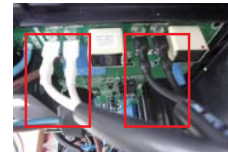
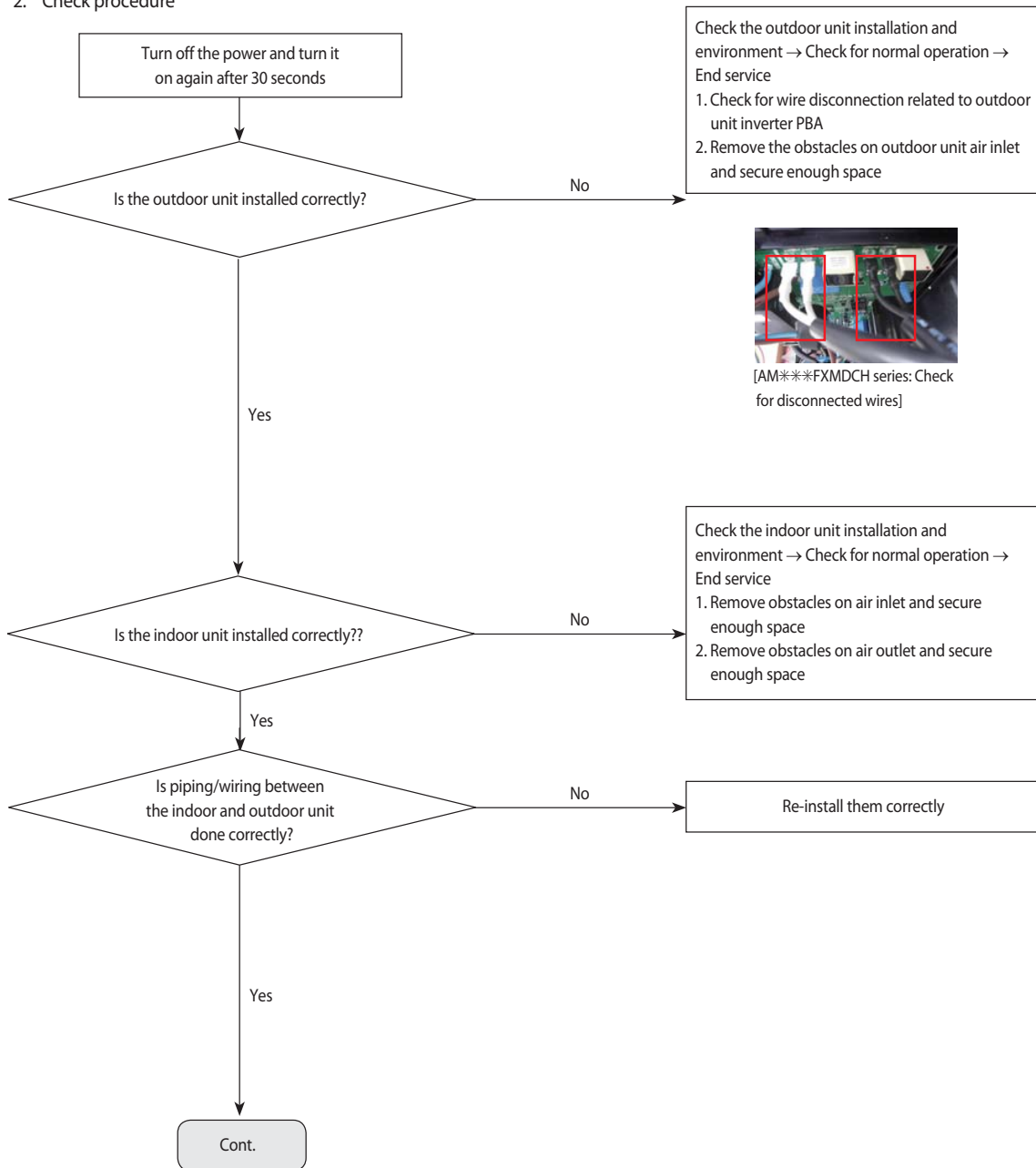

[AM***FXMDCH series: Check for disconnected wires]

IPM over current error (Error Code : E464) (cont.)

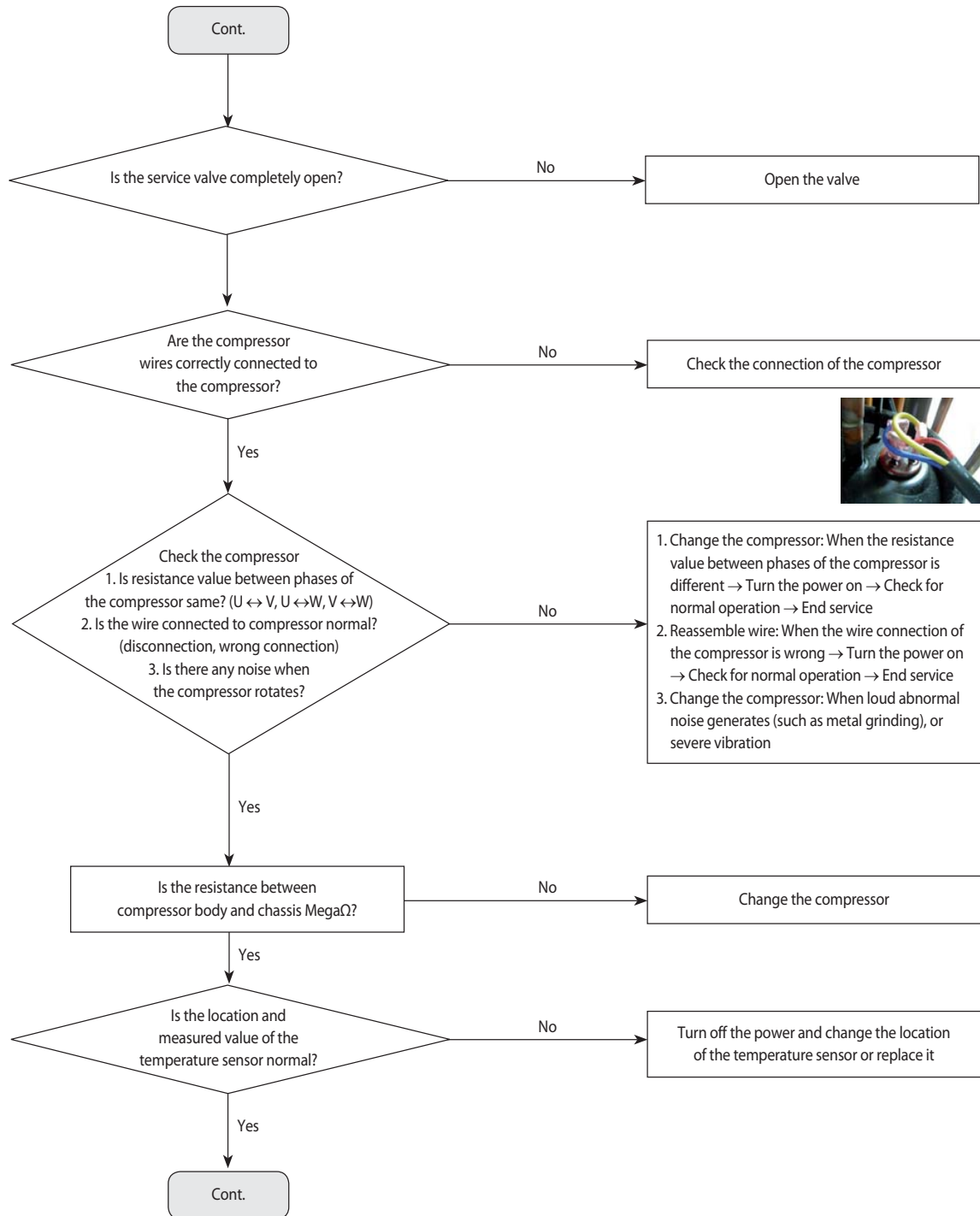

IPM over current error (Error Code : E464) (cont.)

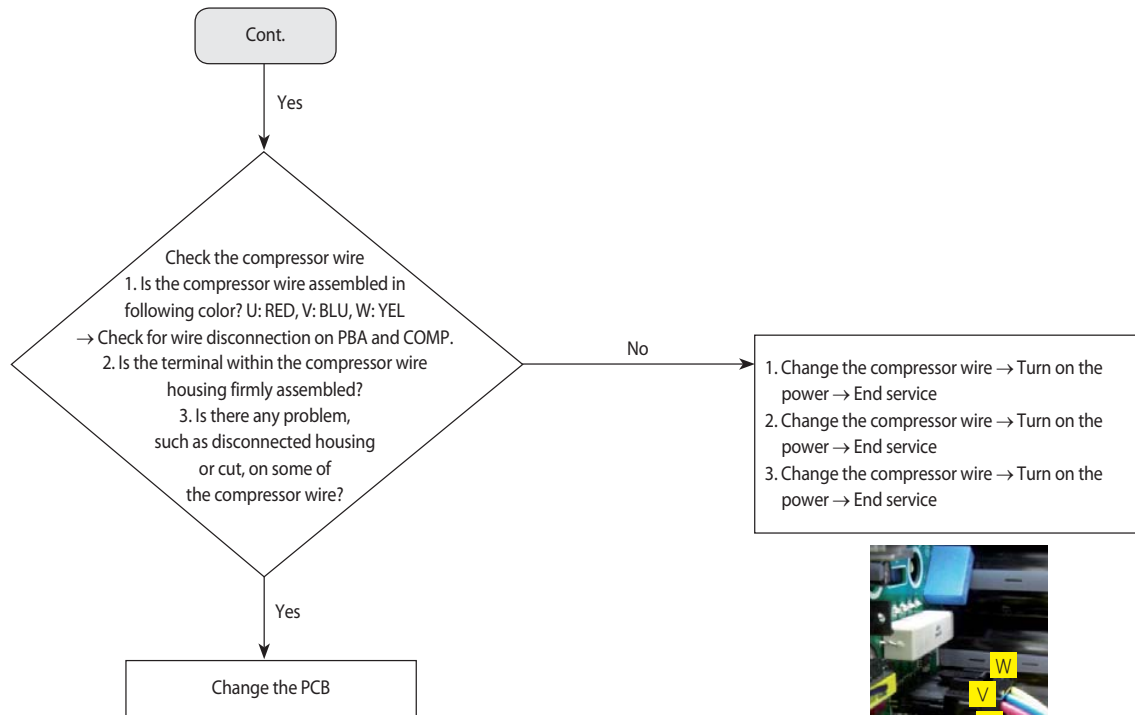

[AM***FXMDCH series]

* Do not change the EMI/outdoor unit main/ Indoor unit main PBA when E464 error occurs
 → It is Compressor, inverter PBA related error, therefore it is not related to above PBA

3-20 DC-Link voltage under/over error (Error Code : E466)

1. Check items

- 1) Check the power and restarting after power reset
 - Is there any problem with input power?
(1 Phase: 220Vac, 3 Phase: 380Vac)
 - Does error occur again during operation after power reset?
- 2) Check the power cable connection, and joint cable connection
- 3) Check the reactor and reactor wire
- 4) Check the fuse on the EMI PBA
- 5) Check the Terminal block, power terminal cabinet and the power wire assembly

2. Check procedure

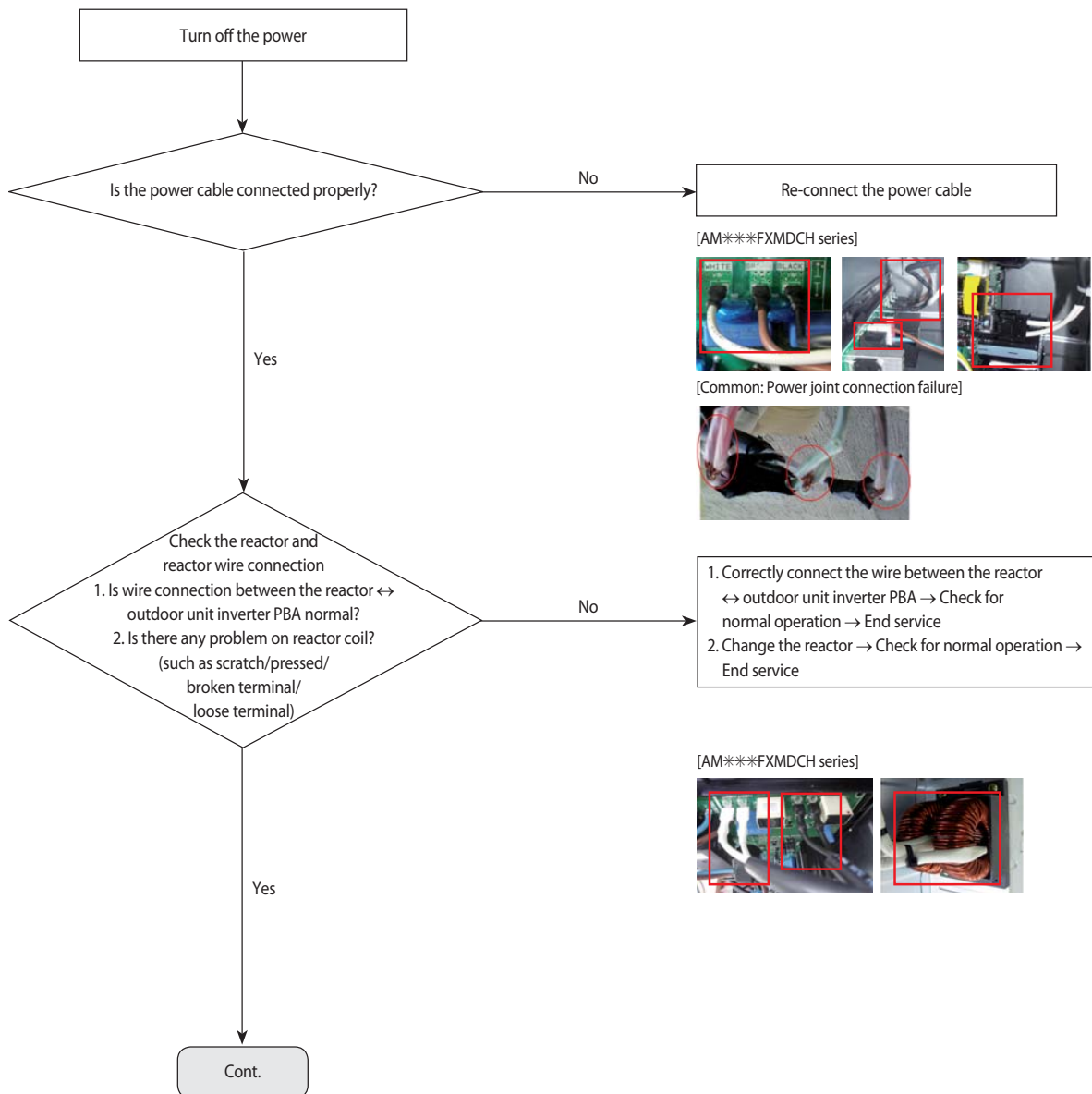

DC-Link voltage under/over error (Error Code : E466) (cont.)

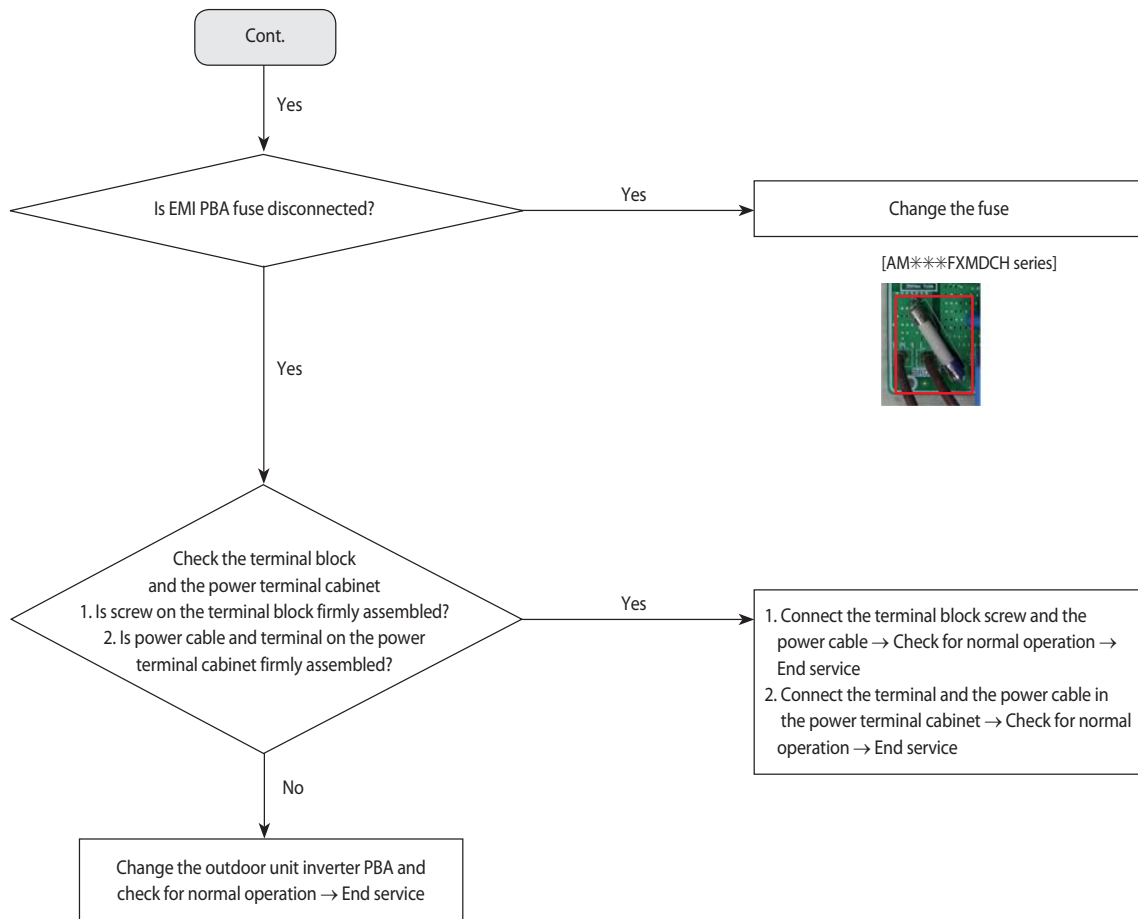

3-21 Gas leak error (Error Code : E554)

1. Check items

- 1) Check the power and restarting after power reset
 - Is there any problem with input power?
(1 Phase: 220Vac, 3 Phase: 380Vac)
 - Does error occur again during operation after power reset?
- 2) Check the compressor and compressor wire assembly
- 3) Check the outdoor unit installation and environments
 - Check if the outdoor unit inverter PBA related wires are disconnected. Check the installation environment
 - If there were multiple installation, check if the communication cable and the pipes are installed correctly.

2. Check procedure

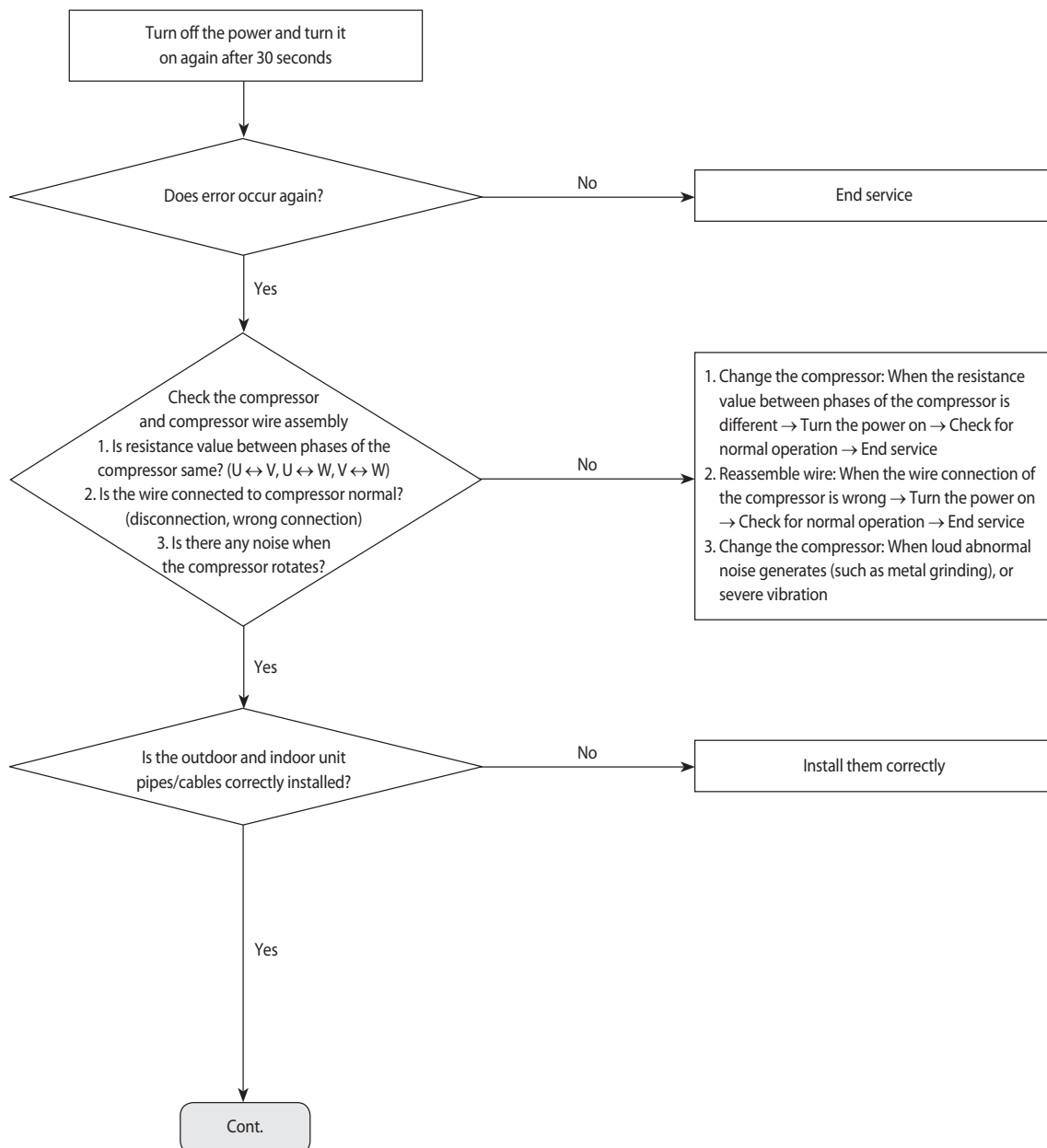

Gas leak error (Error Code : E554) (cont.)

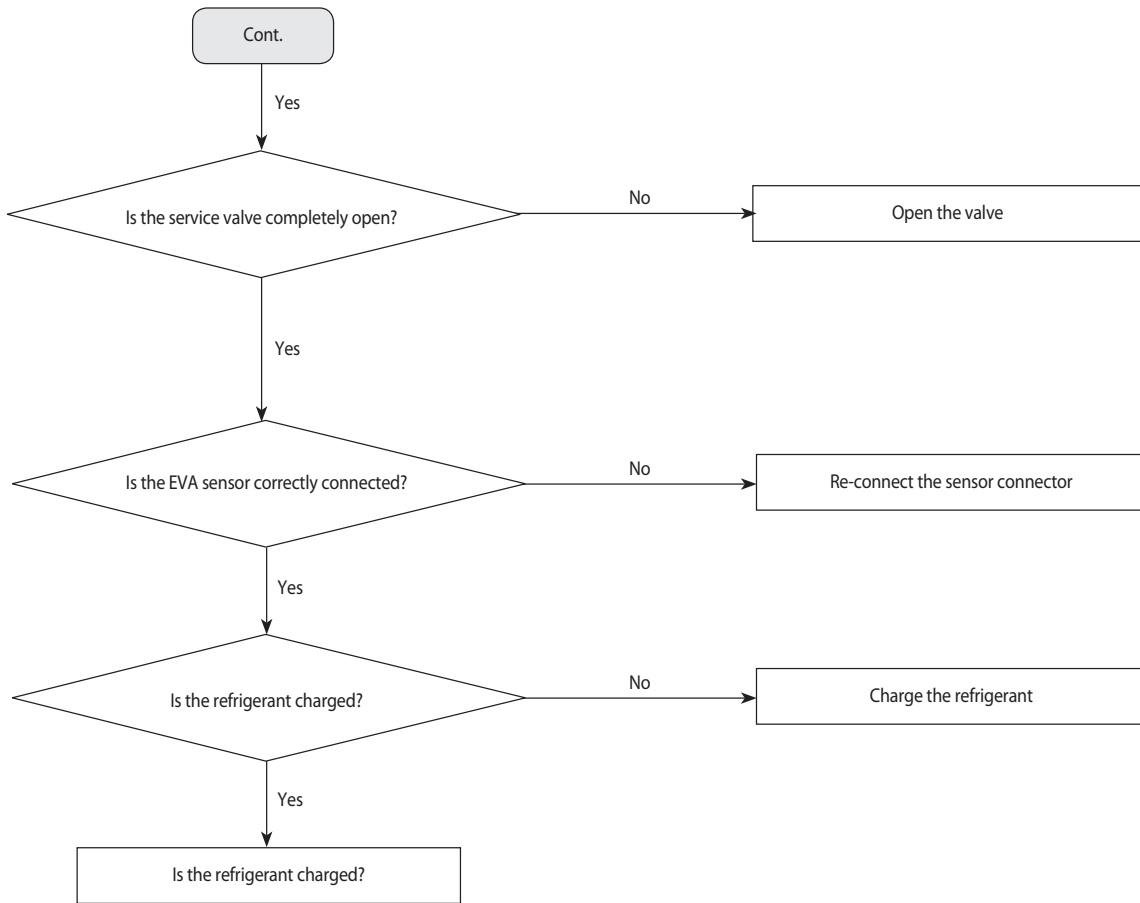

3-22 Others

1. Compressor Vlimit error: E465

If the compressor operation is abnormal, change the compressor and check for normal operation

→ If the compressor operation is normal, check the assembly between heat sink plate and if there is no problem, change the inverter PBA

2. Current sensor error: E468

EEPROM Uploading at indoor main PBA, Check if PCB operation is normal

3. OTP error: E471

Error occurs when the EEPROM DATA in the outdoor unit main PBA and inverter PBA is different from each other. Check the model name and EEPROM code to use it

4. DC link voltage sensor error: E469

Error occurs when DC LINK value is not normal (DC LINK VOLTAGE: 280~320V)

Check the value of DC link when error occurs and check the reactor disconnection

5. Heat sink temperature error: E474, E500

Error occurs when heat sink of the inverter PBA exceeds rated range

Clean and remove any dust and other foreign substances on the outdoor unit and then check the connection between heat sink and inverter PBA

Make sure grease is applied properly and screw is firmly fixed

6. Input current sensor error: E485

Detect the input sensor while the set is in stop status to check if there's any problem

When error occurs, turn on/off the power for number of time and if same error occurs while the power is off, change the inverter PBA

7. EEPROM read/write error: E470

Error occurs when there is no EEPROM data in the set. Check the model name and insert EEPROM for corresponding model or load the EEPROM data.

PCB Diagram

Outdoor Unit PCB

- Main PCB

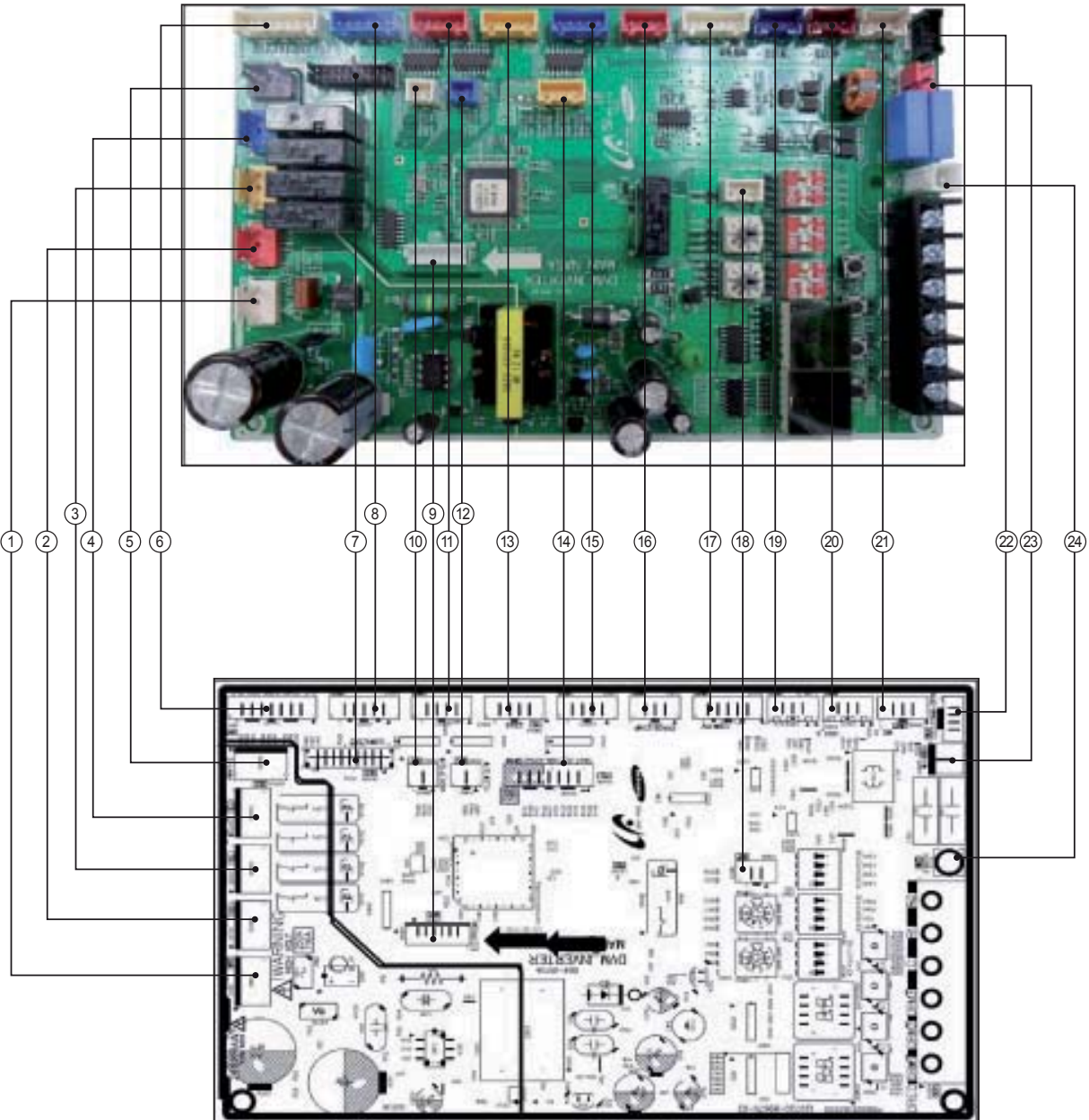

Main PCB (cont.)

① CN101-AC INPUT #1~#3 : 220~240Vac	② CN701-HOT GAS #1~#3 : 220~240Vac	③ CN702-4WAY VALVE 1 #1~#3 : 220~240Vac	④ CN703-BASE HEATER #1~#3 : 220~240Vac
⑤ CN704-4WAY VALVE 2 #1~#3 : 220~240Vac	⑥ CN403- TEMP SENSOR #1 : OUT TEMP #2,4,6,8: GND #3 : COND TEMP #5 : DISCHARGE TEMP #7 : OLP SENSOR	⑦ CN306-MICOM DOWNLOAD #1~#10 : Micom down	⑧ CN802-EEV 1 #1~4 : EEV signal #5,6 : DC 12V
⑨ CN806-E2P MODULE	⑩ CN002-HIGH P S/W #1 : INPUT #2 : GND	⑪ CN803-EEV 2 #1~4 : EEV signal #5 : DC 12V	⑫ CN001-Flow S/W #1 : INPUT #2 : GND
⑬ CN804-EEV 3 #1~4 : EEV signal #5 : DC 12V	⑭ CN406-	⑮ CN805-EEV 4 #1~4 : EEV signal #5 : DC 12V	⑯ CN801-EXTERNAL CONTROL OUT #1,3 : DC 12V #2 : ERROR CHECK OUT #4 : COM CHK OUT
⑰ CN305-COMM INV PBA	⑱ CN501-SELECT COOLING ONLY	⑲ CN401-LOW P SENSOR #2 : INPUT #3 : GND #4 : VCC	⑳ CN401-HIGH P SENSOR #1 : INPUT #3 : GND #4 : VCC
㉑ CN401-MID P SENSOR #1 : INPUT #2 : GND #4 : VCC	㉒ CN302-COMM SUB PBA	㉓ CN303-COM INDOOR UNIT	㉔ CN103-EARTH

Outdoor Unit PCB (cont.)

- Inverter PCB : 1Phase II

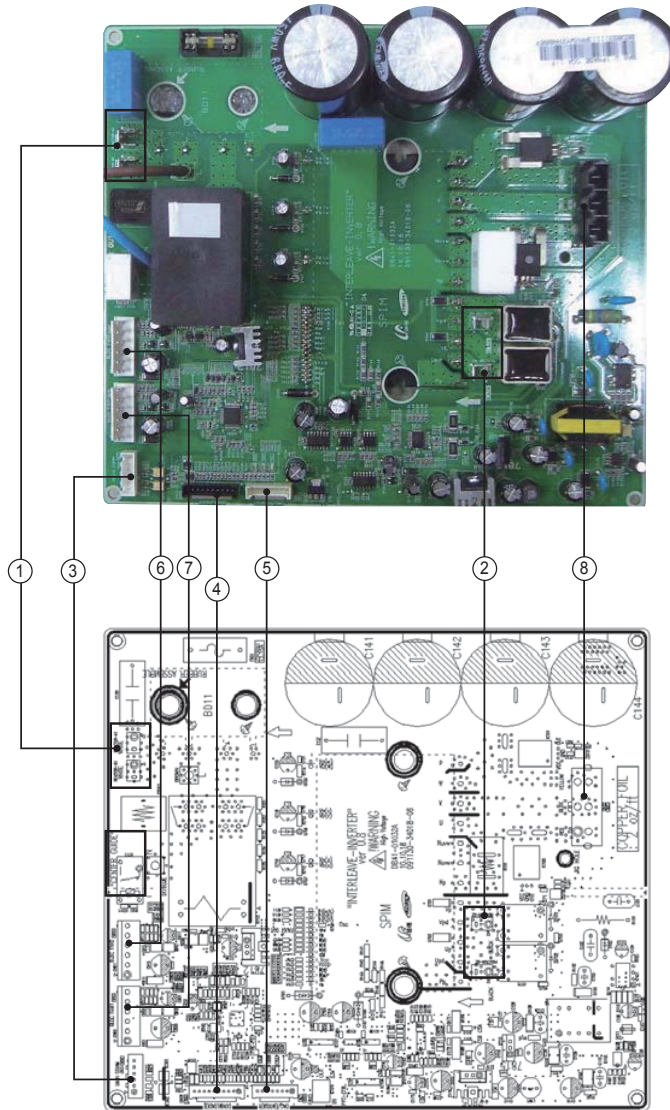

<p>① Reactor-A1/B1 #Reactor-A2 : WHT #Reactor-B2 : WHT</p>	<p>② Reactor-A2/B2 #Reactor-A2 : BLK #Reactor-B2 : BLK</p>	<p>③ CN31-MAIN COMM #1 : RXD#2 : TXD #3 : GND, #4 : DC 5V #5 : DC 12V, #6 : INV. SMPS signal</p>	<p>④ CN22-Downloader #1 : RXD_ATARO, #2 : TXD_ATARO #3, #8 : N.C, #4~#7 : DATA signal #9 : GND, #10 : DC 5V</p>
<p>⑤ CN21-DAC/ENCODER For S/W engineer debugging</p>	<p>⑥ CN91-FAN2 #1 : DC 360V #2 : N.C #3 : GND #4 : DC 15V #5 : FAN RPM #6 : FAN RPM feedback</p>	<p>⑦ CN90-FAN1 #1 : DC 360V #2 : N.C #3 : GND #4 : DC 15V #5 : FAN RPM #6 : FAN RPM feedback</p>	<p>⑧ CN71-COMP. #1 : COMP. U-phase(RED) #2 : COMP. V-phase(BLU) #3 : COMP. U-phase(YEL)</p>

Outdoor Unit PCB (cont.)

- EMI PCB : 1Phase

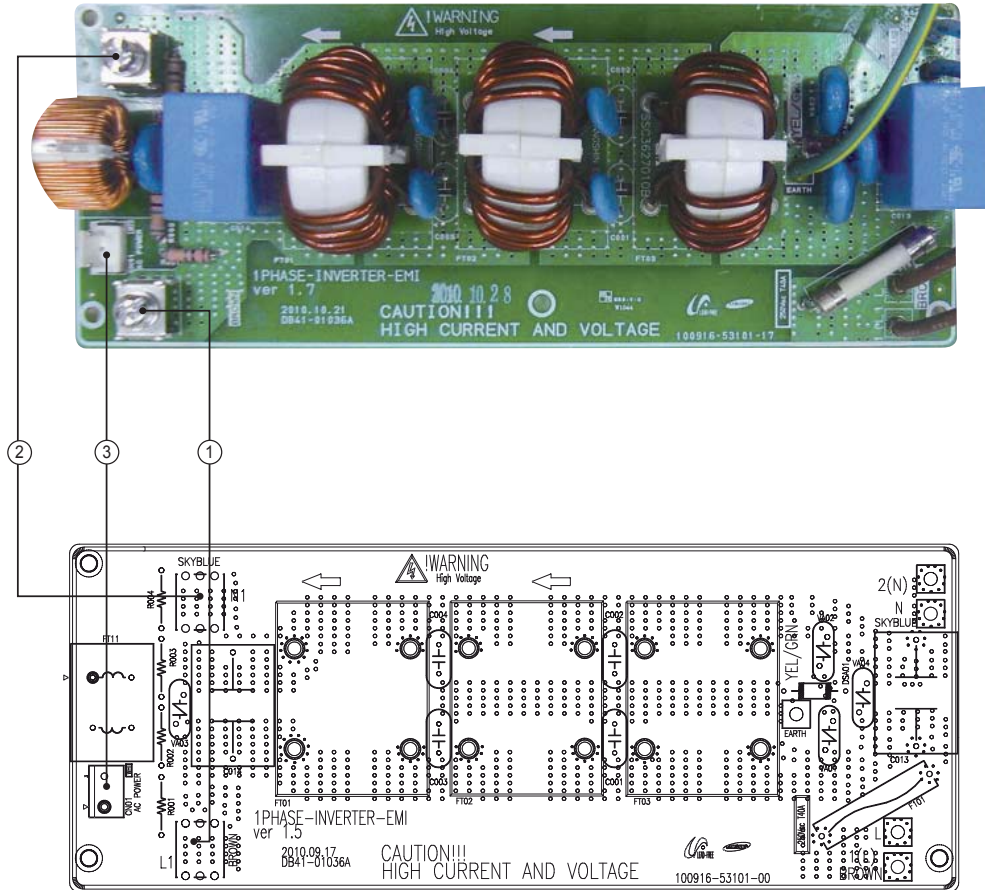

<p>① L1-AC POWER L phase L1 : BRN</p>	<p>② N1-AC POWER N phase N1 : SKY-BLU</p>	<p>③ CN01-AC POWER #1-#3 : AC 220~240V</p>
--	--	---

■ Wiring Diagram

■ 1 Phase

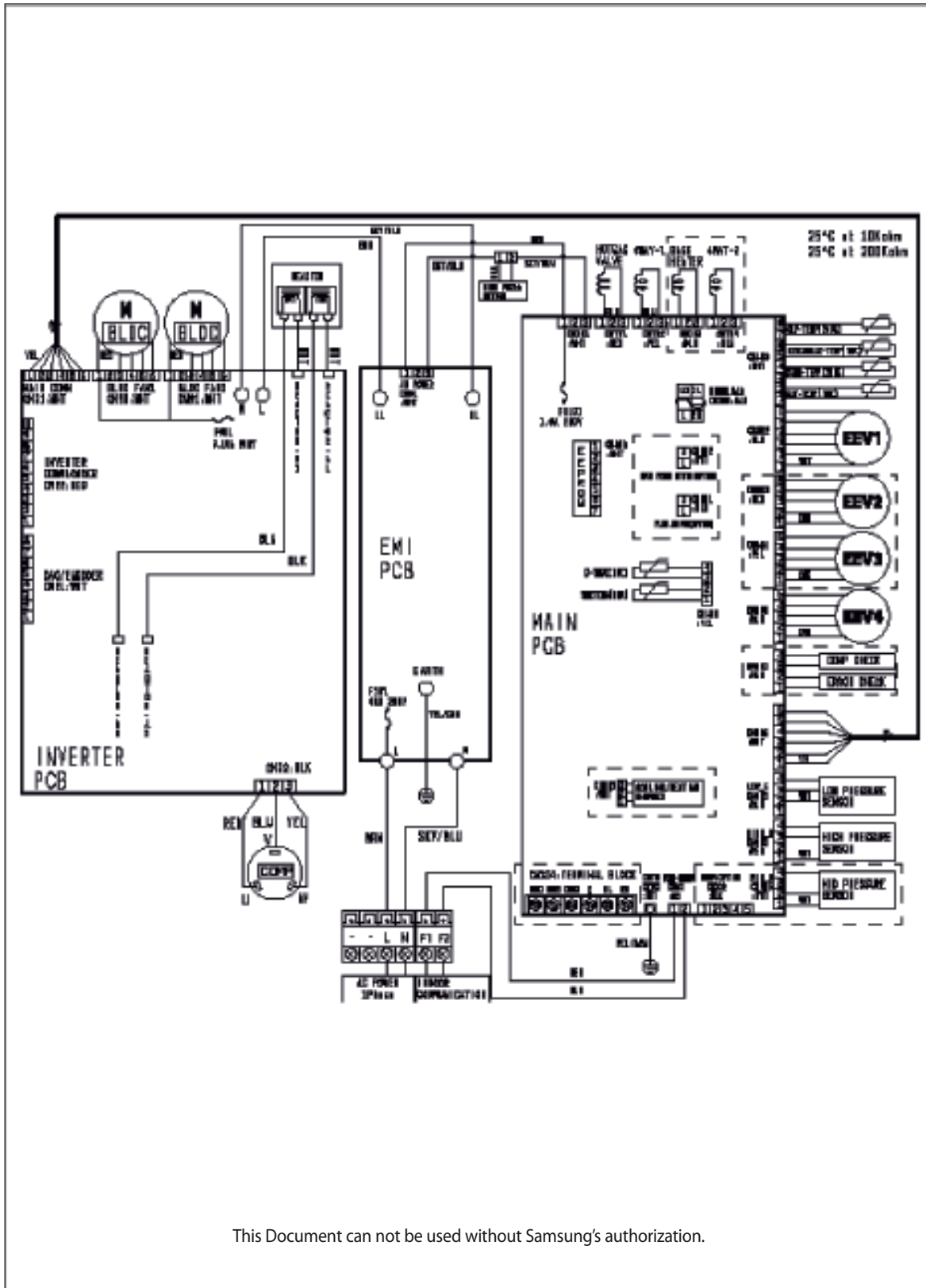

This Document can not be used without Samsung's authorization.

Reference Sheet

1. Refrigerant cycle diagram

OUTDOOR UNIT

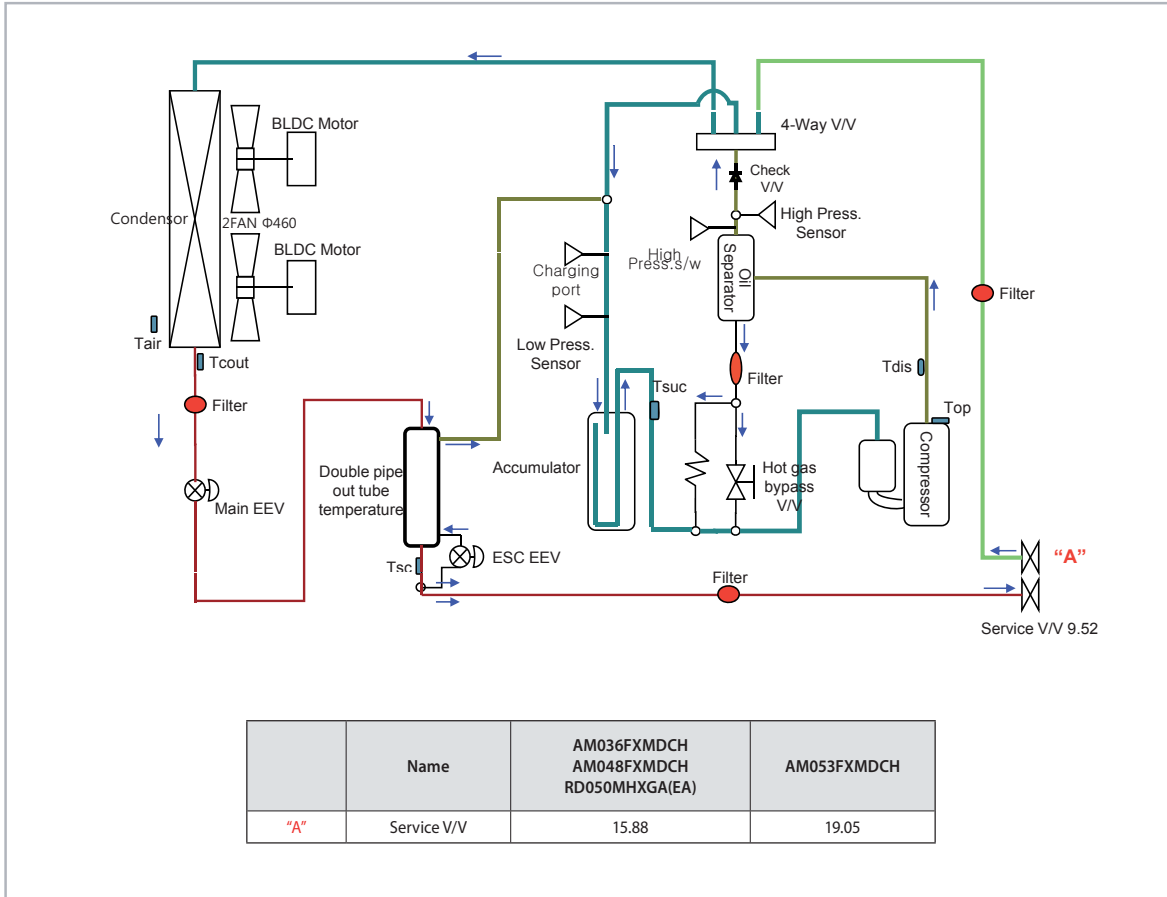

2. Nomenclatures

OUTDOOR UNIT

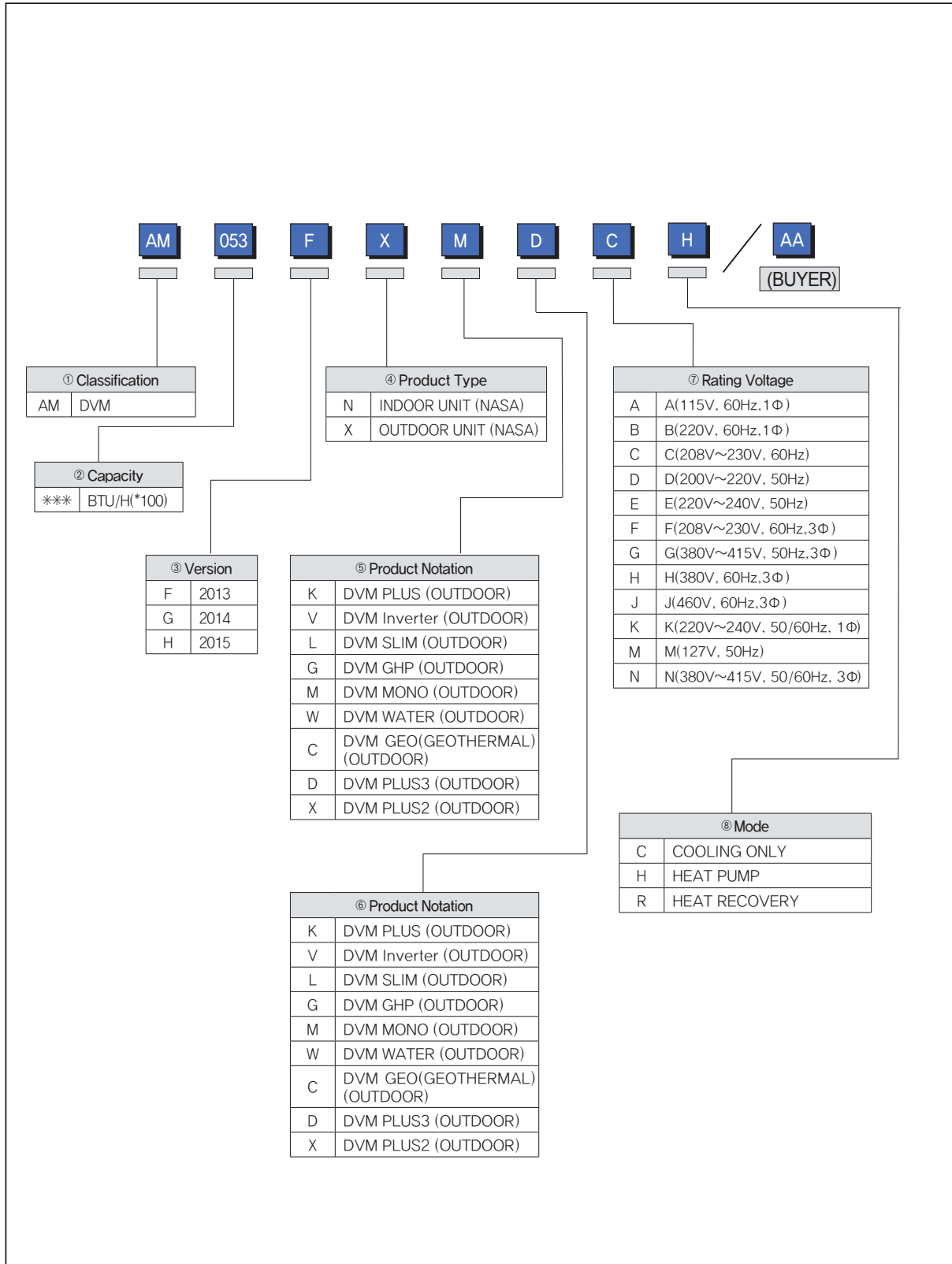

■ Check Operation & Amount of Refrigerant Automatically Checking

1. Check Operation

1-1 Check Operation

1) What is the Check Operation?

DVM MINI main components defective check and check the status of the installation, provide guidelines that can promptly and accurately resolve the problems that may occur in the field.

If does not end the Automatic Commissioning, normal operation is impossible to enter, it should protect the system from the abnormal state. ("UP")

2) Check operation Preliminary checking.

- (1) Check the Power cable of Indoor / Outdoor Unit and communication wire.
- (2) Turn on the power 3 hours before to start the Check operation. (Crankcase heater to be heated sufficiently.)
- (3) Check before applying power voltage and phase using a phase tester and voltmeter.
phase-to-phase, 220V (R-N, S-N, T-N).
- (4) Power on, perform the tracking. (Outdoor Unit inspects Indoor Unit and optional.)
- (5) Card to verify the installation of the control box front : must be record the installation details.
※ Necessarily turn on the power 3 hours before to start the Check operation.

3) How to use the Check operation.

- (1) Check operation, use the Key Mode. (Pressing the K1 Tact Switch for a long time)



- If does not complete the Check operation, Display the "UP"(Unprepared) on the LED after checking communication.
(Compressor to operate general operation is prohibited.)

※ UP Mode will be turned off automatically at finished the Check operation.

- Check operation is carried out by the operating conditions.

(From 30 minutes to maximum 50 minutes)

- During Check operation due to the valve check, the noise can be generated. (Sustained abnormal noise occurs, check it)

- (2) When an error occurs during the Check operation, check the error code in the product and then service it.

- (3) Shut down the Check operation, resulting report will be issued using the S-NET or S-CHECKER.

- The resulting report of the "Undetermined"item, troubleshoot the accordance with the service manual.

- Troubleshoot all the items of "Undetermined" and then restart the Check operation.

- (4) Check the following as Check operation. (Heating / Cooling)

- Check the Cooling and Heating operation is progressing well.

- Individual Indoor Unit control : check the wind direction, wind speed.

- Check the Indoor and Outdoor abnormal noise.

- Check the drainage of the Indoor Unit cooling operation.

- More operation : Checking status by using the S-NET.

- (5) Refer to manual and explain air conditioner usage to user.

- (6) Deliver this installation guide so that customer retain.

※ If out of warranty coverage and bounds, installation, operation according to the conditions the some of items displayed as "Undetermined" and judgment is not.

Ex) system that module installed : If the outdoor unit is not operation by the load on the indoor and outdoor, corresponding Sub Outdoor Unit does not judge the inspection entries. (However, Indoor / Outdoor Temperature sensor and Pressure sensor judgment is available.)

4) Inspection item of the Check operation

During the Check operation of the DVM MINI, defect check items are as follows.

- Indoor Unit Temperature sensor (Indoor temperature of each Indoor Unit, EVA In/Out Temperature sensor)
- Outdoor Unit Temperature sensor
(Outdoor temperature of each Outdoor Unit, Cond_Out, Suction, Liquid Pipe Temperature sensor)
- Outdoor Unit High Pressure sensor & Low Pressure sensor
- Outdoor Unit Compressor : Judgment of the operation current
- Cycle state judgment of the Outdoor Unit
- Outdoor Unit 4Way Valve : Judgment of the operation
- Outdoor Unit MAIN EEV : Judgment of the operation

(※ The operation mode of the Automatic Commissioning : "Heating" only if the detection.)

5) Warranty Coverage of the Check operation

As follows, in order to accurately measure Indoor / Outdoor temperature conditions in the Check operation is carried out.

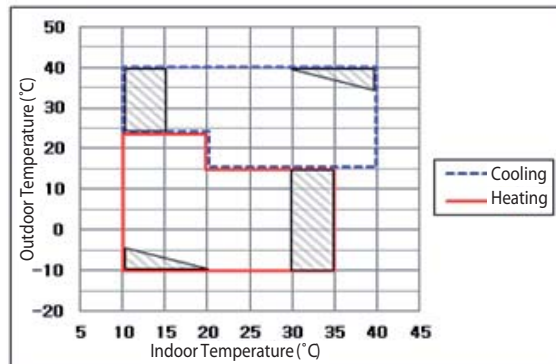

- Heating / Cooling mode is automatically selected of Check operation.
- Oblique line marked area in the during operation of the system can be protection control.
(Check operation of normal judgment can be difficult by the protection control operation.)
- If out of warranty coverage and the boundary area : Check operation judgment accuracy may be reduced.

1-2 How to troubleshoot of the "Undetermined"

1) Indoor Unit Temperature sensor

- Inspection item : Indoor temperature of each Indoor Unit, EVA In / Out Temperature sensor
- Error code: None (The resulting report "Undetermined")
- Determine the status of the Temperature sensor of the Indoor Unit installed before the compressor start.
- Commissioning methods

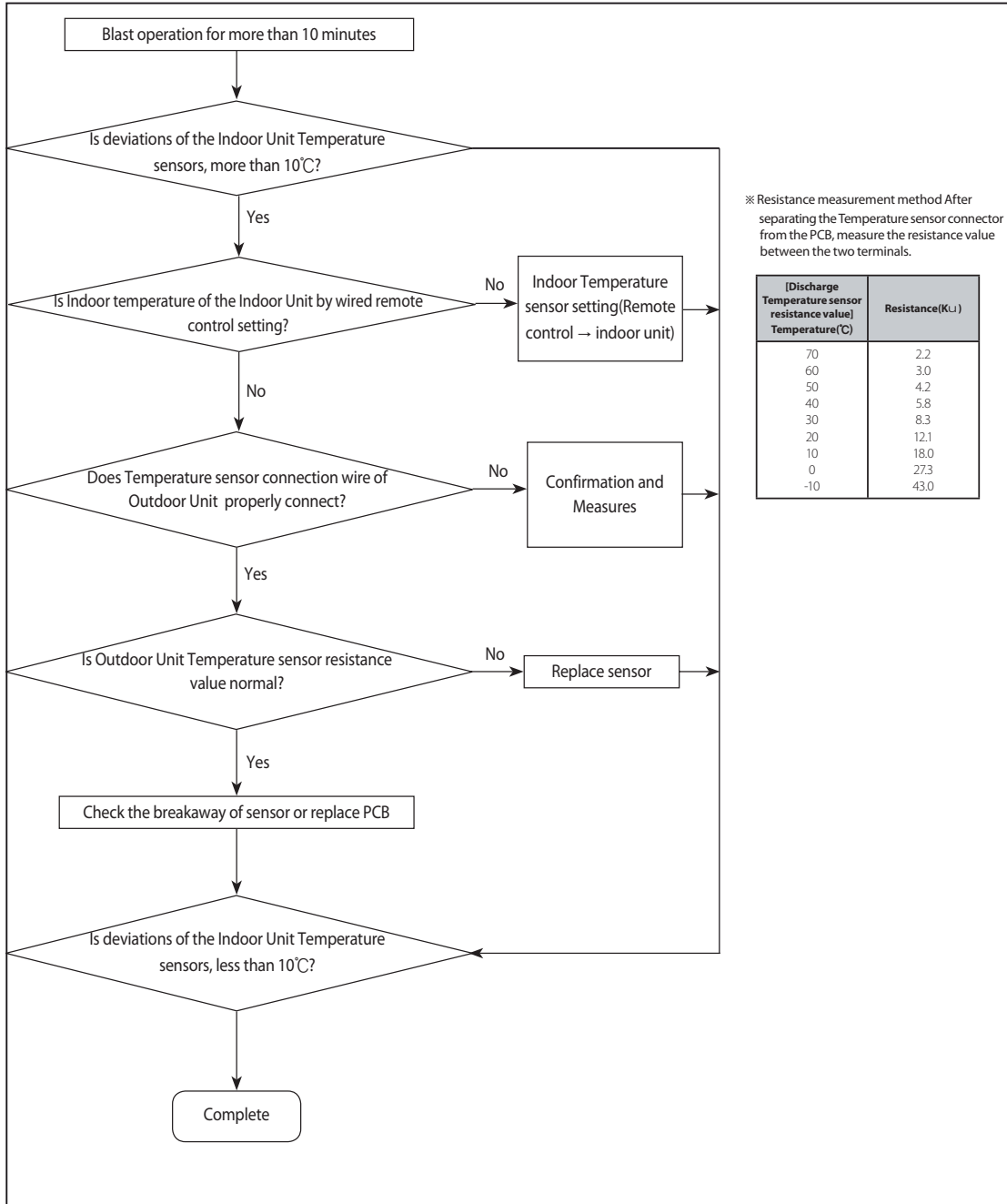

[Caution]

- If the Outdoor Unit with a history of operation (Automatic commissioning inclusion) : Must be carried out Automatic Commissioning after 1 hour from final operation stopped.

2) Outdoor Unit Temperature sensor

- Inspection item : Outdoor temperature of each Outdoor Unit, Cond_Out, Suction, Liquid pipe temperature sensor
- Error code: None (The resulting report "Undetermined")
- Determine the status of the Temperature sensor of the each Outdoor Unit installed before the compressor start.
- If the judgment of Outdoor Unit Temperature sensor is "Undetermined" : Checking in accordance with the following order.

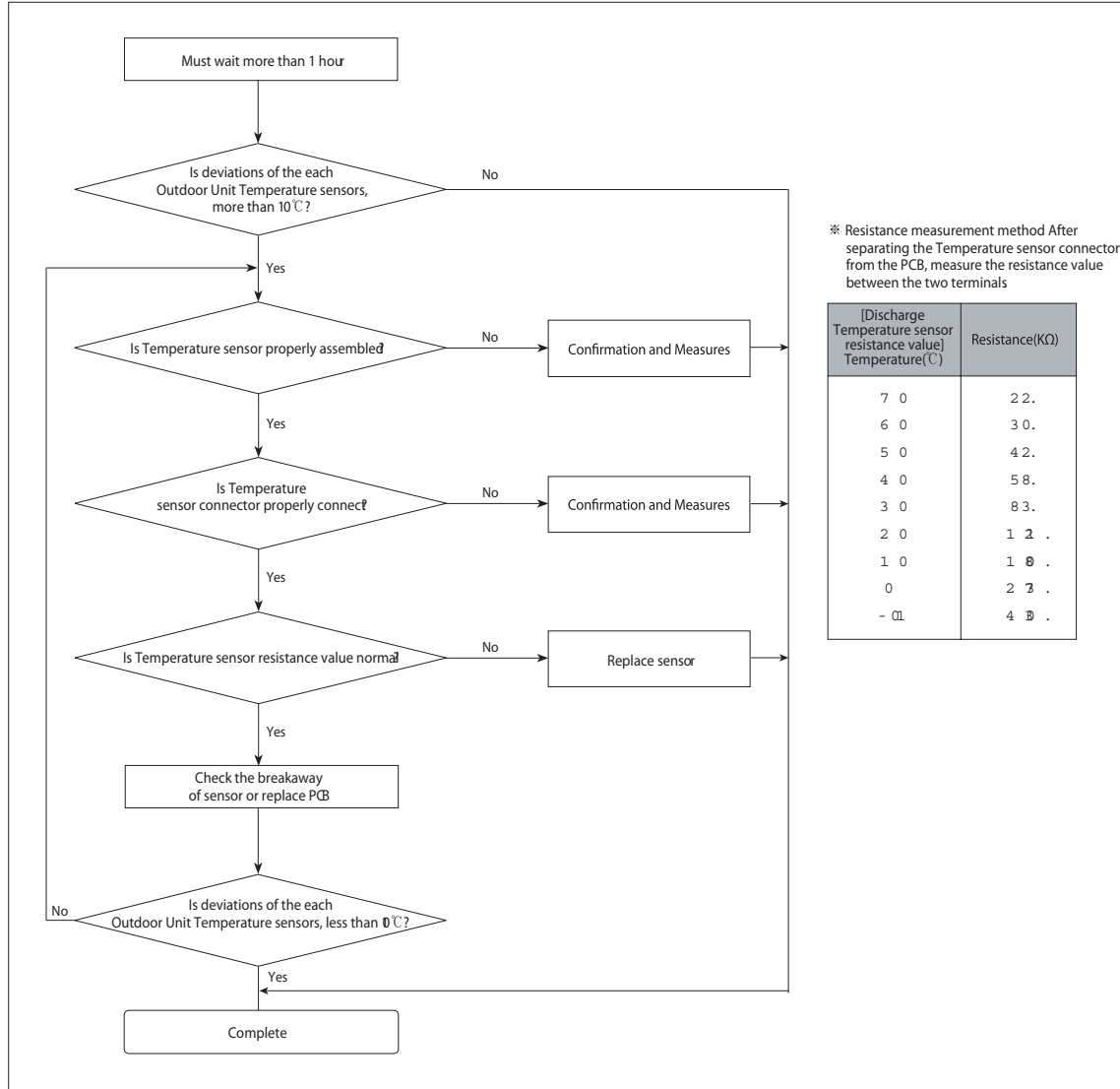

※ Resistance measurement method After separating the Temperature sensor connector from the PCB, measure the resistance value between the two terminals

[Discharge Temperature sensor resistance value] Temperature(°C)	Resistance(KΩ)
7 0	2 2 .
6 0	3 0 .
5 0	4 2 .
4 0	5 8 .
3 0	8 3 .
2 0	1 2 .
1 0	1 8 .
0	2 3 .
- 0.1	4 8 .

[Caution]
 ⚠ If the Outdoor Unit with a history of operation (Automatic commissioning inclusion) : Must be carried out Automatic Commissioning after 1 hour from final operation stopped.

3) Pressure sensor

- Inspection item : High/Low Pressure sensor of the independent installed Outdoor Unit.
- Error code: None (The resulting report "Undetermined")
- Determine the status of the Pressure sensor of the independent installed Outdoor Unit before the compressor start.
- If the judgment of Outdoor Unit Pressure sensor is "Undetermined" : Checking in accordance with the following order.

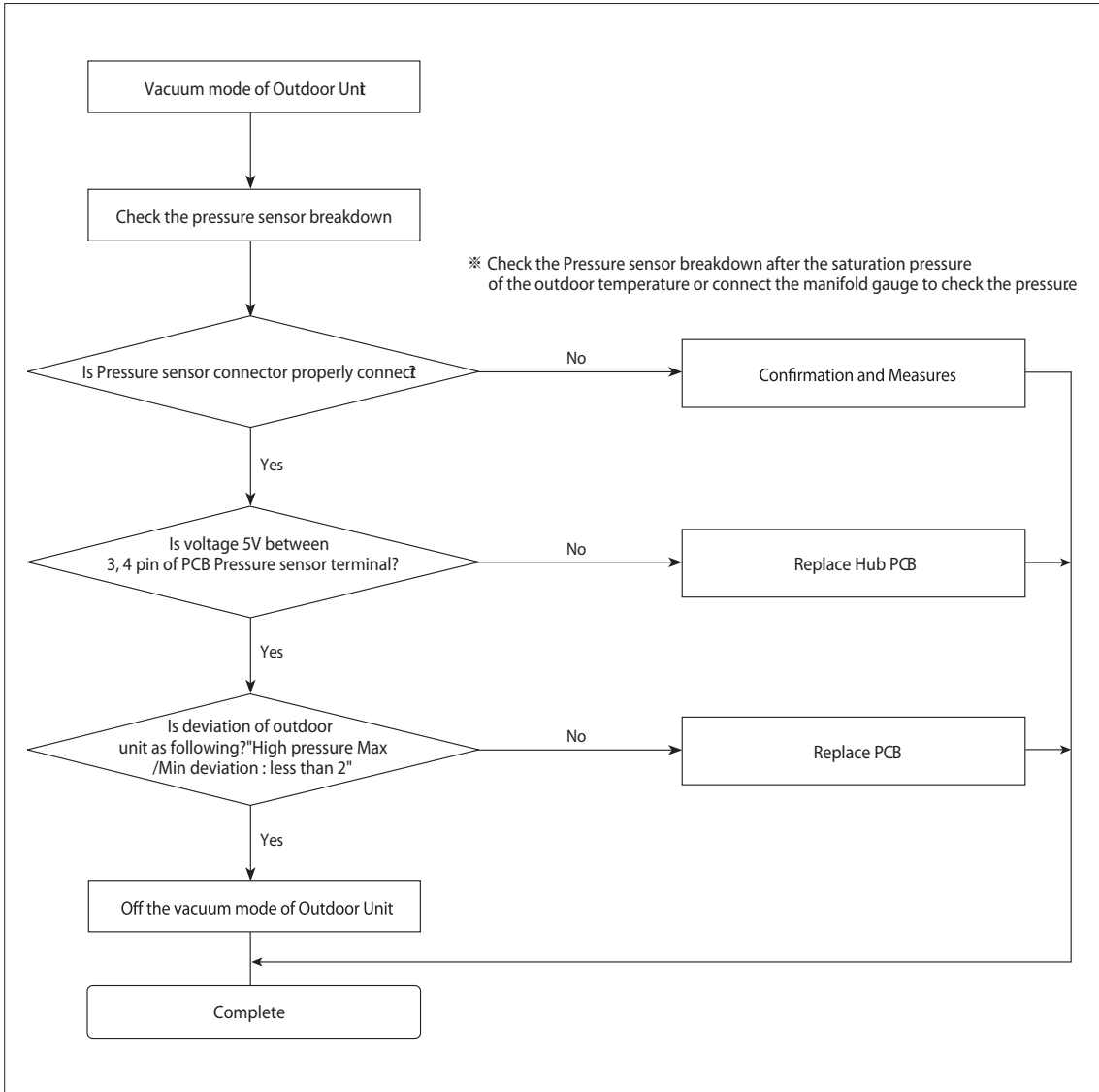

[Caution] - If the Outdoor Unit with a history of operation (Automatic commissioning inclusion) : Maintain the vacuum mode for more than 5 minutes.

4) Abnormal operation of the Compressor

- Inspection item : Operation current of Outdoor Unit Compressor.
- Error code: None (The resulting report "Undetermined")
- Determine the status of the operating current of the each Outdoor Unit Compressor.
- If the judgment of operation current of Outdoor Unit Compressor is "Undetermined" :
Checking in accordance with the following order.

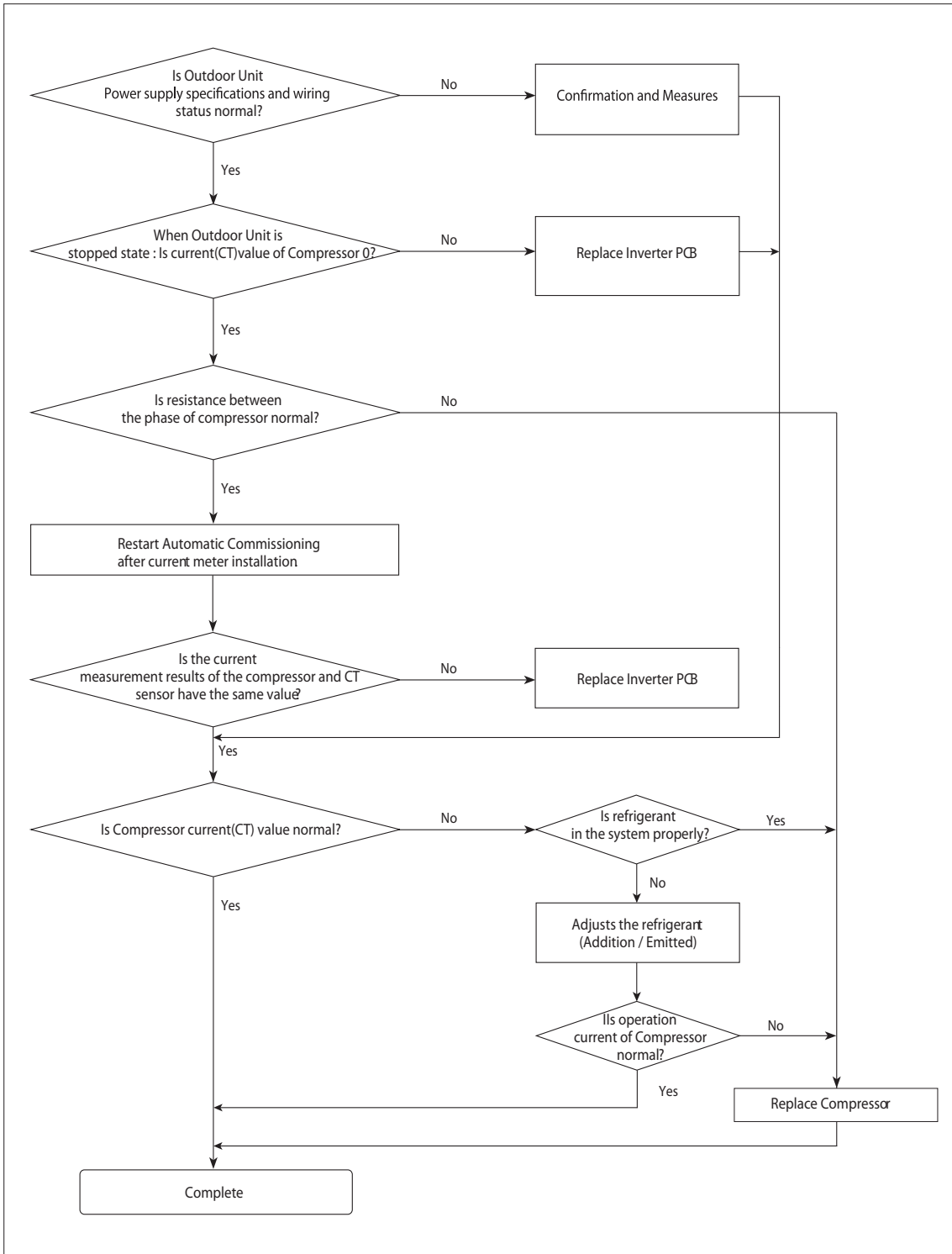

5) Cycle status

- Inspection item : Cycle status of Outdoor Unit.
- Error code: None (The resulting report "Undetermined")
- Determine the Cycle status of the each Outdoor Unit.
- If the judgment of Cycle status is "Undetermined" : Checking in accordance with the following order.

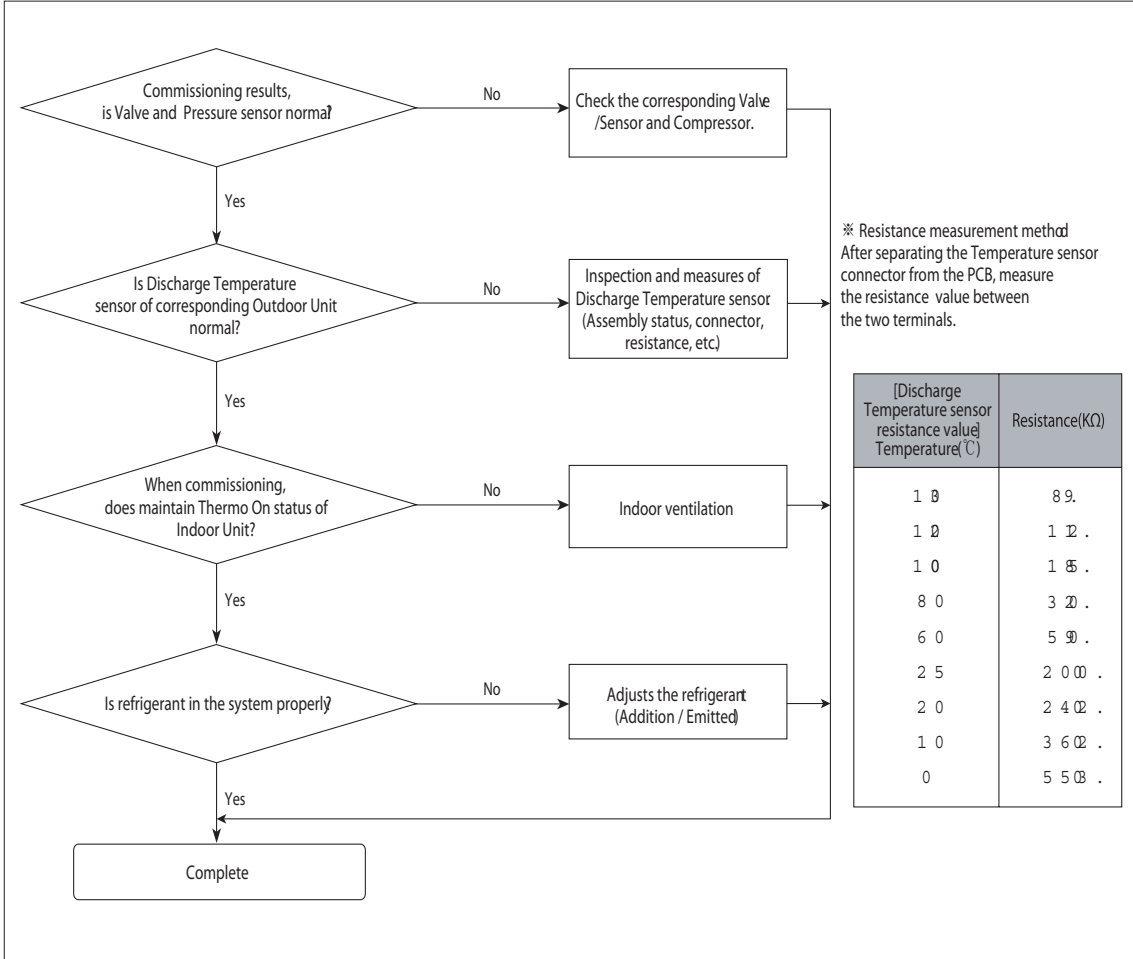

6) 4Way Valve

- Inspection item : 4Way Valve of Outdoor Unit.
- Error code: None (The resulting report "Undetermined")
- Determine the 4Way Valve operation status of the each Outdoor Unit.
- If the judgment of 4Way Valve is "Undetermined" : Checking in accordance with the following order.

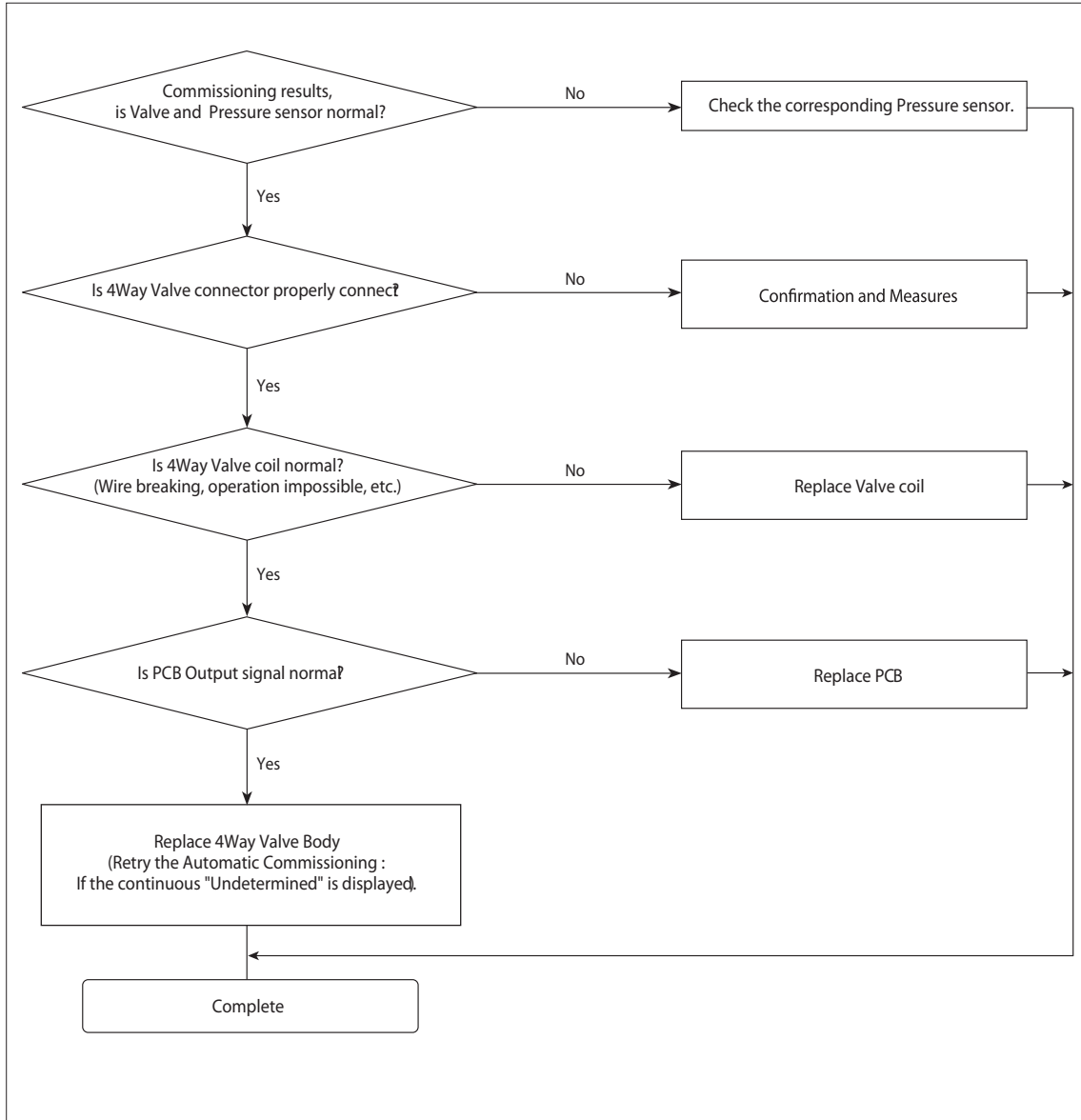

7) Main EEV

- Inspection item : Main EEV of Outdoor Unit.(Automatic Commissioning : Heating only)
- Error code: None (The resulting report "Undetermined")
- Determine the Main EEV operation status of the each Outdoor Unit.
- If the judgment of Main EEV is "Undetermined" : Checking in accordance with the following order.

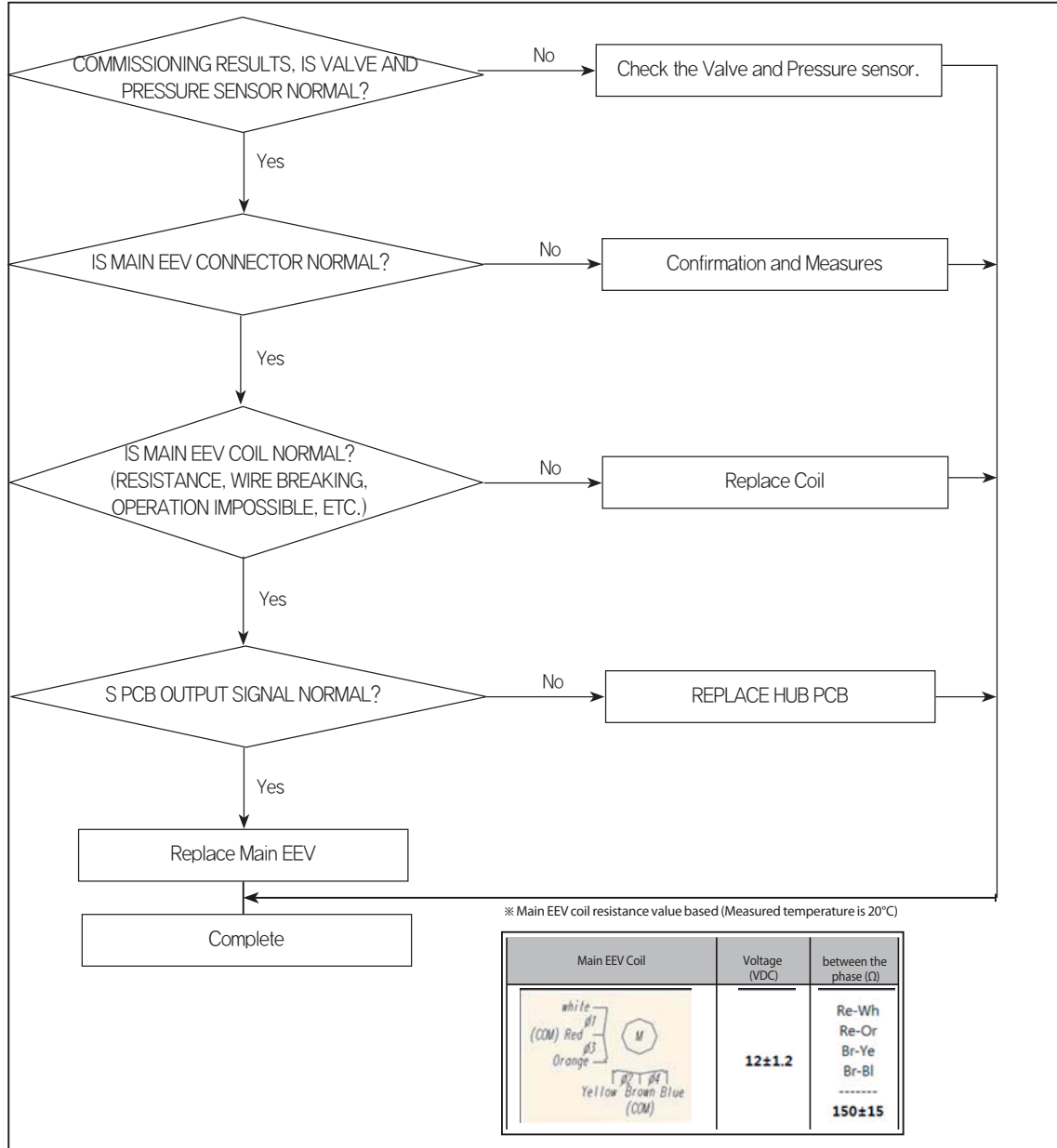

1-3 Automatic Commissioning Error Code

Division	Error Code	Description	Remark
Dedicated Error Code	E503	Service Valve is closed	Refer to "Service Valve"
	E505	High pressure sensor breakdown	Refer to "High/Low pressure sensor (Module installed)"
	E506	Low pressure sensor breakdown	

※ Other error codes : Refer to Service Manual.

2. Amount of Refrigerant Automatically Checking

Through the detect operation is the ability to verify automatically for the amount of refrigerant.

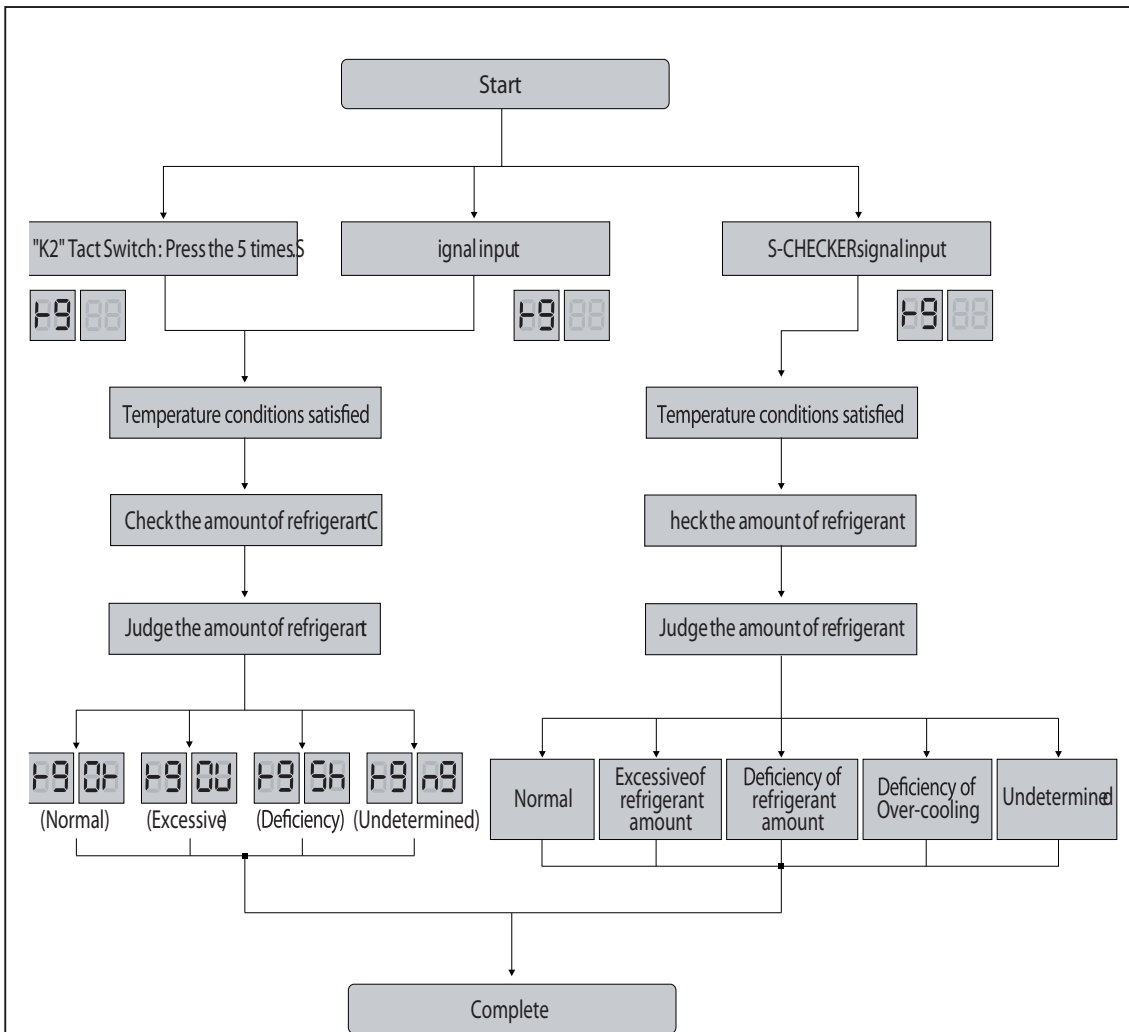

⚠ [Caution]

- If escape the warranty temperatures, can not get the accurate results.
 - Indoor : 20~30°C
 - Outdoor : 5~43°C
- If operation cycle is not stable, refrigerant detection operation can be forced to shut down.
- If did not operation for a long time, or when running the heating operation, the accuracy may be lower. Therefore carried out for more than 30 minutes cooling operation.
- Depending on the installation environment, system protection operation is performed, in this case, the amount of refrigerant checked result maybe inaccurate.

[How to troubleshoot the judged results]

- Excessive of refrigerant amount : After the 5% emissions of calculated total refrigerant amount, retry refrigerant detection operation.
- Deficiency of refrigerant amount : After the 5% addition of calculated total refrigerant amount, retry refrigerant detection operation.
- Undetermined : Refrigerant detection operation confirms that is performed in warranty temperatures area. Ensure that there is no other problems in the system by Commissioning.



GSPN (GLOBAL SERVICE PARTNER NETWORK)

Area	Web Site
Europe, CIS, Mideast & Africa	gspn1.samsungcspportal.com
Asia	gspn2.samsungcspportal.com
North & Latin America	gspn3.samsungcspportal.com
China	china.samsungportal.com

This Service Manual is a property of Samsung Electronics Co., Ltd.
Any unauthorized use of Manual can be punished under applicable
International and/or domestic law.

© Samsung Electronics Co., Ltd. February. 2013.
Printed in Korea.
Code No. AC-00013E_1