

TECHNICAL & SERVICE MANUAL

R410A

Outdoor unit
[model names]

PUHZ-RP3VHA

PUHZ-RP4VHA

PUHZ-RP5VHA

PUHZ-RP6VHA

[Service Ref.]

PUHZ-RP3VHA

PUHZ-RP4VHA

PUHZ-RP5VHA

PUHZ-RP6VHA

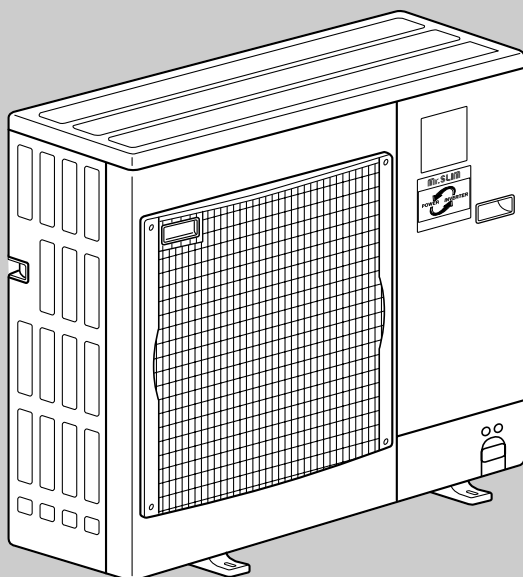

CONTENTS

1. SAFETY PRECAUTION.....	3
2. COMBINATION OF INDOOR AND OUTDOOR UNITS...	7
3. PART NAMES AND FUNCTIONS	7
4. SPECIFICATIONS.....	8
5. DATA	10
6. OUTLINES AND DIMENSIONS.....	12
7. WIRING DIAGRAM	14
8. WIRING SPECIFICATIONS	16
9. REFRIGERANT SYSTEM DIAGRAM	17
10. TROUBLESHOOTING.....	21
11. DISASSEMBLY PROCEDURE.....	66
12. PARTS LIST	76
13. OPTIONAL PARTS.....	Back Cover

1-1. CAUTIONS RELATED TO NEW REFRIGERANT

<Cautions for units utilizing refrigerant R410A>

Use new refrigerant pipes.

In case of using the existing pipes for R22, be careful with the followings.

- For RP4, 5 and 6, be sure to perform replacement operation before test run.
- Change flare nut to the one provided with this product. Use a newly flared pipe.
- Avoid using thin pipes.

Make sure that the inside and outside of refrigerant piping is clean and it has no contamination such as sulfur hazardous for use, oxides, dirt, shaving particles, etc. In addition, use pipes with specified thickness.

Contamination inside refrigerant piping can cause deterioration of refrigerant oil etc.

Store the piping to be used during installation indoors and keep both ends of the piping sealed until just before brazing. (Leave elbow joints, etc. in their packaging.)

If dirt, dust or moisture enter into refrigerant cycle, that can cause deterioration of refrigerant oil or malfunction of compressor.

Use ester oil, ether oil or alkylbenzene oil (small amount) as the refrigerant oil applied to flares and flange connections.

If large amount of mineral oil enter, that can cause deterioration of refrigerant oil etc.

Charge refrigerant from liquid phase of gas cylinder.

If the refrigerant is charged from gas phase, composition change may occur in refrigerant and the efficiency will be lowered.

Do not use refrigerant other than R410A.

If other refrigerant (R22 etc.) is used, chlorine in refrigerant can cause deterioration of refrigerant oil etc.

Use a vacuum pump with a reverse flow check valve.

Vacuum pump oil may flow back into refrigerant cycle and that can cause deterioration of refrigerant oil etc.

Use the following tools specifically designed for use with R410A refrigerant.

The following tools are necessary to use R410A refrigerant.

Tools (for R410A)	
Gauge manifold	Flare tool
Charge hose	Size adjustment gauge
Gas leak detector	Vacuum pump adaptor
Torque wrench	Electronic refrigerant charging scale

Keep the tools with care.

If dirt, dust or moisture enter into refrigerant cycle, that can cause deterioration of refrigerant oil or malfunction of compressor.

Do not use a charging cylinder.

If a charging cylinder is used, the composition of refrigerant will change and the efficiency will be lowered.

Ventilate the room if refrigerant leaks during operation. If refrigerant comes into contact with a flame, poisonous gases will be released.

[1] Cautions for service

- (1) Perform service after collecting the refrigerant left in unit completely.
- (2) Do not release refrigerant in the air.
- (3) After completing service, charge the cycle with specified amount of refrigerant.
- (4) When performing service, install a filter drier simultaneously.
Be sure to use a filter drier for new refrigerant.

[2] Additional refrigerant charge

When charging directly from cylinder

- Check that cylinder for R410A on the market is syphon type.
- Charging should be performed with the cylinder of syphon stood vertically. (Refrigerant is charged from liquid phase.)

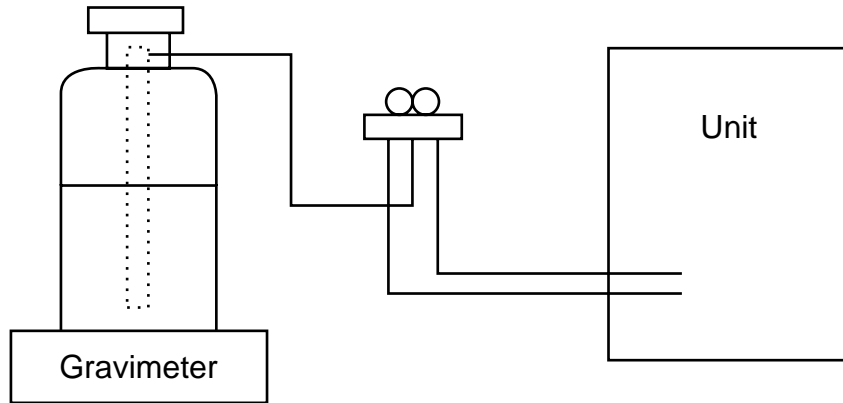

[3] Service tools

Use the below service tools as exclusive tools for R410A refrigerant.

No.		Specifications
①	Gauge manifold	·Only for R410A
		·Use the existing fitting specifications. (UNF1/2)
		·Use high-tension side pressure of 5.3MPa·G or over.
②	Charge hose	·Only for R410A
		·Use pressure performance of 5.09MPa·G or over.
③	Electronic scale	—
④	Gas leak detector	·Use the detector for R134a, R407C or R410A.
⑤	Adaptor for reverse flow check	·Attach on vacuum pump.
⑥	Refrigerant charge base	—
⑦	Refrigerant cylinder	·Only for R410A Top of cylinder (Pink)
		Cylinder with syphon
⑧	Refrigerant recovery equipment	—

1-2. Changed point

• Precautions when reusing existing R22 refrigerant pipes

(1) Flowchart

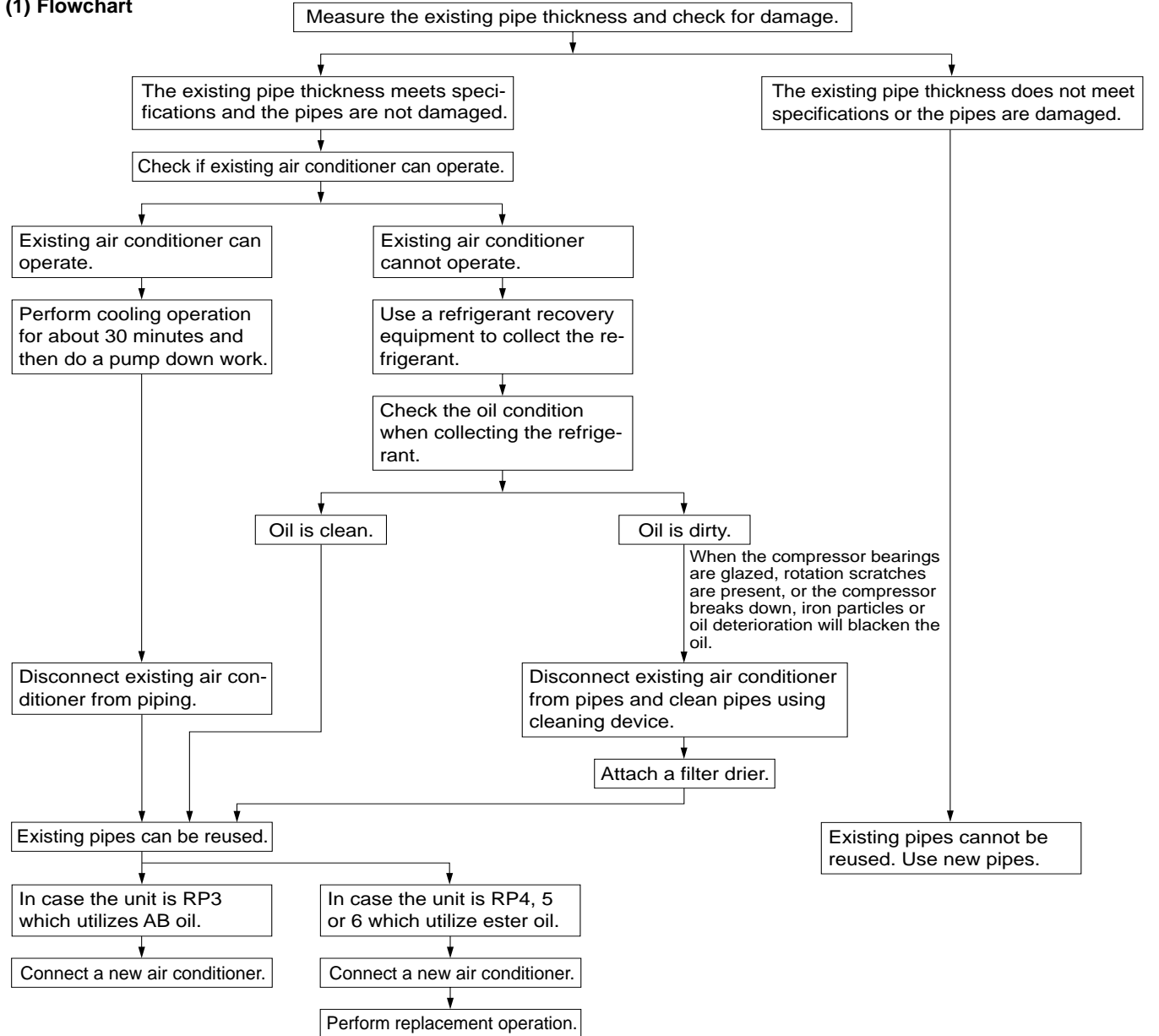

•When performing replacement operation, make sure that DIP SW8-2 on outdoor unit controller board is set to ON.

*Chemical compounds containing chlorine left in existing pipes are collected by replace filter.

●The air conditioner automatically performs cooling operation through replace filter for about 2 hours.

Connecting a new air conditioner

①Flaring work should be done so that flare meets the dimension for R410A. Use flare nut provided with indoor and outdoor unit.
②When using gas piping of $\phi 19.05\text{mm}$ for RP4, 5 and 6. Make sure that DIP SW8-1 on outdoor unit controller board is set to ON. *This is to keep the pressure on pipes within permissible range. ●Use different diameter joint or adjust the piping size by brazing.
③When using pipes larger than specified size for RP3. Make sure that DIP SW8-1 on outdoor unit controller board is set to ON. *This is to prevent oil flow ratio from lowering due to the decrease in flowing refrigerant. ●Use different diameter joint or adjust the piping size by brazing.
④When existing pipes are specified size. The pipes can be reused referring to table 1 on page 18. ●Use different diameter joint or adjust the piping size by brazing.
★When using existing pipes for RP4, 5 and 6. Make sure that DIP SW8-2 on outdoor unit controller board is set to ON and perform replacement operation. *Chemical compounds containing chlorine left in existing pipes are collected by replace filter. ●The air conditioner automatically performs cooling operation through replace filter for about 2 hours.

(2) Cautions for refrigerant piping work

New refrigerant R410A is adopted for replacement inverter series. Although the refrigerant piping work for R410A is same as for R22, exclusive tools are necessary so as not to mix with different kind of refrigerant. Furthermore as the working pressure of R410A is 1.6 time higher than that of R22, their sizes of flared sections and flare nuts are different.

① Thickness of pipes

Because the working pressure of R410A is higher compared to R22, be sure to use refrigerant piping with thickness shown below. (Never use pipes of 0.7mm or below.)

Diagram below: Piping diameter and thickness

Nominal dimensions	Outside diameter (mm)	Thickness (mm)	
		R410A	R22
1/4"	6.35	0.8	0.8
3/8"	9.52	0.8	0.8
1/2"	12.70	0.8	0.8
5/8"	15.88	1.0	1.0
3/4"	19.05	—	1.0

② Dimensions of flare cutting and flare nut

The component molecules in HFC refrigerant are smaller compared to conventional refrigerants. In addition to that, R410A is a refrigerant, which has higher risk of leakage because of its working pressure higher than that of other refrigerants. Therefore, to enhance airtightness and intensity, flare cutting dimension of copper pipe for R410A have been specified separately from the dimensions for other refrigerants as shown below. The dimension B of flare nut for R410A also have partly been changed to increase intensity as shown below. Set copper pipe correctly referring to copper pipe flaring dimensions for R410A below. For 1/2" and 5/8", the dimension B changes. Use torque wrench corresponding to each dimension.

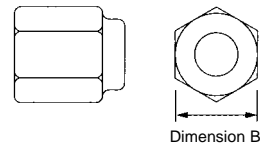
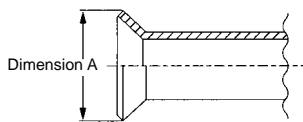

Flare cutting dimensions (mm)

Nominal dimensions	Outside diameter	Dimension A (mm)	
		R410A	R22
1/4"	6.35	9.1	9.0
3/8"	9.52	13.2	13.0
1/2"	12.70	16.6	16.2
5/8"	15.88	19.7	19.4
3/4"	19.05	—	23.3

Flare nut dimensions (mm)

Nominal dimensions	Outside diameter	Dimension B (mm)	
		R410A	R22
1/4"	6.35	17.0	17.0
3/8"	9.52	22.0	22.0
1/2"	12.70	26.0	24.0
5/8"	15.88	29.0 *	27.0
3/4"	19.05	—	36.0

*36.0mm for indoor unit of RP4, 5 and 6

③ Tools for R410A (The following table shows whether conventional tools can be used or not.)

Tools and materials	Use	R410A tools	Can R22 tools be used?	Can R407C tools be used?
Gauge manifold	Air purge and refrigerant charge	Tool exclusive for R410A	×	×
Charge hose	Operation check and the two above	Tool exclusive for R410A	×	×
Gas leak detector	Gas leak check	Tool for HFC refrigerant	×	○
Refrigerant recovery equipment	Collection of refrigerant	Tool exclusive for R410A	×	×
Refrigerant cylinder	Refrigerant charge	Tool exclusive for R410A	×	×
Applied oil	Apply to flared section	Ester oil and alkylbenzene oil (minimum amount)	×	Ester oil: ○ Alkylbenzene oil: minimum amount
Safety charger	Prevent compressor malfunction when charging refrigerant by spraying liquid refrigerant	Tool exclusive for R410A	×	×
Charge valve	Prevent gas from blowing out when detaching charge hose	Tool exclusive for R410A	×	×
Vacuum pump	Vacuum drying and air purge	Tools for other refrigerants can be used if equipped with adopter for reverse flow check	△ (Usable if equipped with adopter for reverse flow)	△ (Usable if equipped with adopter for reverse flow)
Flare tool	Flaring work of piping	Tools for other refrigerants can be used by adjusting flaring dimension	△ (Usable by adjusting flaring dimension)	△ (Usable by adjusting flaring dimension)
Bender	Bend the pipes	Tools for other refrigerants can be used	○	○
Pipe cutter	Cut the pipes	Tools for other refrigerants can be used	○	○
Welder and nitrogen gas cylinder	Weld the pipes	Tools for other refrigerants can be used	○	○
Refrigerant charging scale	Charge refrigerant	Tools for other refrigerants can be used	○	○
Vacuum gauge or thermistor vacuum gauge and vacuum valve	Check the degree of vacuum. (Vacuum valve prevents back flow of oil and refrigerant to thermistor vacuum gauge)	Tools for other refrigerants can be used	○	○
Charging cylinder	Charge refrigerant	Tool exclusive for R410A	×	—

× : Prepare a new tool. (Use the new tool as the tool exclusive for R410A.)

△ : Tools for other refrigerants can be used under certain conditions.

○ : Tools for other refrigerants can be used.

2

COMBINATION OF INDOOR AND OUTDOOR UNITS

	Indoor unit		Outdoor unit			
			Heat pump type			
	Service Ref.	Service Manual No.	PUHZ-RP			
			3	4	5	6
		VHA	VHA	VHA	VHA	
Heat pump without electric heater	PEAD-RP•EA	—	○	○	○	○
	PLA-RP•AA	OC293	○	○	○	○
	PLA-RP•AA.UK	OC297	○	○	○	○

3

PART NAMES AND FUNCTIONS

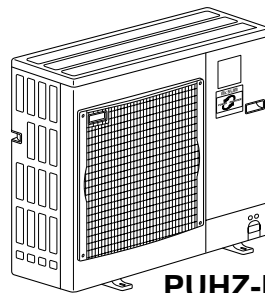

PUHZ-RP3VHA

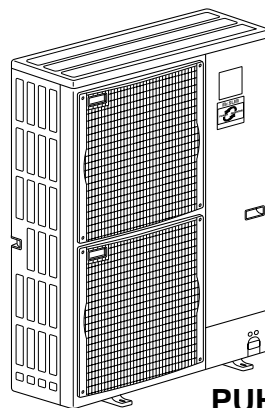

**PUHZ-RP4VHA
PUHZ-RP5VHA
PUHZ-RP6VHA**

CHARGELESS SYSTEM

**PRE-CHARGED REFRIGERANT IS SUPPLIED FOR PIPING LENGTH AT SHIPMENT.
(Max.30m(PUHZ-RP3~RP6))**

The refrigerant circuit with LEV(Linear Expansion Valve) and power receiver always control the optimal refrigerant level regardless of the length (30m max. and 5m min.) of piping. The additional refrigerant charging work during installation often causes problems. Heretofore it is completely eliminated. This unique system improves the quality and reliability of the work done. It also helps to speed up the installation time.

Service Ref.			PUHZ-RP3VHA		PUHZ-RP4VHA	
Function			Cooling	Heating	Cooling	Heating
Power supply (phase, cycle, voltage)			Single, 50Hz, 220-230-240V			
Input		kW	1.81	2.18	2.78	3.14
Running current		A	8.04	9.74	12.33	13.94
External finish			Munsell 3Y 7.8/1.1			
Refrigerant control			Linear Expansion Valve			
Compressor			Hermetic			
Model			TNB220FMBH		ANV33FDAMT	
Motor output		kW	1.6		1.9	
Starter type			Line start			
Protection devices			HP switch Discharge thermo		HP switch LP switch Discharge thermo	
Crankcase heater		W	—			
Heat exchanger			Plate fin coil			
Fan	Fan(drive) × No.		Propeller (direct) × 1		Propeller (direct) × 2	
	Fan motor output		0.06		0.06+0.06	
	Airflow		55(1,940)		100(3,530)	
Defrost method			Reverse cycle			
Noise level	Cooling	dB	47		49	
	Heating	dB	48		51	
Dimensions	W	mm(in.)	950(37-3/8)			
	D	mm(in.)	330+30(13+1-3/16)			
	H	mm(in.)	943(37-1/8)		1,350(53-1/8)	
Weight		kg(lbs)	75(165)		121(267)	
Refrigerant			R410A			
Charge		kg(lbs)	3.5(7.7)		5.5(12.1)	
Oil (Model)		L	0.87(NEO22)		1.4(MEL56)	
Pipe size O.D.	Liquid	mm(in.)	9.52(3/8)			
	Gas	mm(in.)	15.88(5/8)			
Connection method	Indoor side		Flared			
	Outdoor side		Flared			
Between the indoor & outdoor unit	Height difference		Max. 30m			
	Piping length		Max. 50m		Max. 75m	

Notes1. Rating Conditions (ISO T1)

Cooling : Indoor : D.B. 27°C(80°F), W.B. 19°C(66°F) Outdoor : D.B. 35°C(95°F), W.B. 24°C(75°F)

Heating : Indoor : D.B. 20°C(68°F) Outdoor : D.B. 7°C(45°F), W.B. 6°C(43°F)

Refrigerant piping length (one way) : 5m (16ft)

2. Guaranteed operating range

		Indoor	Outdoor
Cooling	Upper limit	D.B. 35°C, W.B. 22.5°C	D.B. 46°C
	Lower limit	D.B. 19°C, W.B. 15°C	D.B. -5°C
Heating	Upper limit	D.B. 28°C	D.B. 21°C, W.B. 15°C
	Lower limit	D.B. 17°C	D.B. -11°C, W.B. -12°C

3. Above data based on indicated voltage

Indoor Unit 1 phase 230V 50Hz

Outdoor Unit 1 phase 230V 50Hz

Service Ref.		PUHZ-RP5VHA		PUHZ-RP6VHA		
OUTDOOR UNIT	Function	Cooling	Heating	Cooling	Heating	
	Power supply (phase, cycle, voltage)	Single, 50Hz, 220-230-240V				
	Input	kW	3.56	3.94	4.66	4.58
	Running current	A	15.80	17.50	20.73	20.37
	External finish	Munsell 3Y 7.8/1.1				
	Refrigerant control	Linear Expansion Valve				
	Compressor	Hermetic				
	Model	ANV33FDAMT				
	Motor output	kW	2.4		2.9	
	Starter type	Line start				
	Protection devices	HP switch, LP switch, Discharge thermo				
	Crankcase heater	W	—			
	Heat exchanger	Plate fin coil				
	Fan	Fan(drive) × No.	Propeller (direct) × 2			
		Fan motor output	kW	0.06 +0.06		
		Airflow	m³/min(CFM)	100(3,530)		
	Defrost method	Reverse cycle				
	Noise level	Cooling	dB	50		
		Heating	dB	52		
	Dimensions	W	mm(in.)	950(37-3/8)		
D		mm(in.)	330+30(13+1-3/16)			
H		mm(in.)	1,350(53-1/8)			
Weight	kg(lbs)	121(267)				
REFRIGERANT PIPING	Refrigerant	R410A				
	Charge	kg(lbs)	5.5(12.1)			
	Oil (Model)	L	14(MEL56)			
	Pipe size O.D.	Liquid	mm(in.)	9.52(3/8)		
		Gas	mm(in.)	15.88(5/8)		
	Connection method	Indoor side	Flared			
		Outdoor side	Flared			
	Between the indoor & outdoor unit	Height difference	Max. 30m			
		Piping length	Max. 75m			

Notes1. Rating Conditions (ISO T1)

Cooling : Indoor : D.B. 27°C(80°F), W.B. 19°C (66°F) Outdoor : D.B. 35°C(95°F), W.B. 24°C (75°F)
 Heating : Indoor : D.B. 20°C(68°F) Outdoor : D.B. 7°C(45°F), W.B. 6°C (43°F)
 Refrigerant piping length (one way) : 5m (16ft)

2. Guaranteed operating range

		Indoor	Outdoor
Cooling	Upper limit	D.B. 35°C, W.B. 22.5°C	D.B. 46°C
	Lower limit	D.B. 19°C, W.B. 15°C	D.B. -5°C
Heating	Upper limit	D.B. 28°C	D.B. 21°C, W.B. 15°C
	Lower limit	D.B. 17°C	D.B. -11°C, W.B. -12°C

3. Above data based on indicated voltage

Indoor Unit 1 phase 230V 50Hz
 Outdoor Unit 1 phase 230V 50Hz

5-1. REFILLING REFRIGERANT CHARGE (R410A : kg)

Service Ref.	Piping length (one way)							Factory charged
	10m	20m	30m	40m	50m	60m	75m	
PUHZ-RP3VHA	3.1	3.3	3.5	4.1	4.7	—	—	3.5
PUHZ-RP4VHA	5.1	5.3	5.5	6.1	6.7	7.3	7.9	5.5
PUHZ-RP5VHA	5.1	5.3	5.5	6.1	6.7	7.3	7.9	5.5
PUHZ-RP6VHA	5.1	5.3	5.5	6.1	6.7	7.3	7.9	5.5

Longer pipe than this line, additional charge is required.

5-2. COMPRESSOR TECHNICAL DATA

(at 20°C)

Unit		PUHZ-RP3VHA	PUHZ-RP4,5,6VHA
Compressor model		TNB220FMBH	ANV33FDAMT
Winding Resistance (Ω)	U-V	0.865 ~ 0.895	0.266
	U-W	0.865 ~ 0.895	0.266
	W-V	0.865 ~ 0.895	0.266

5-3. NOISE CRITERION CURVES

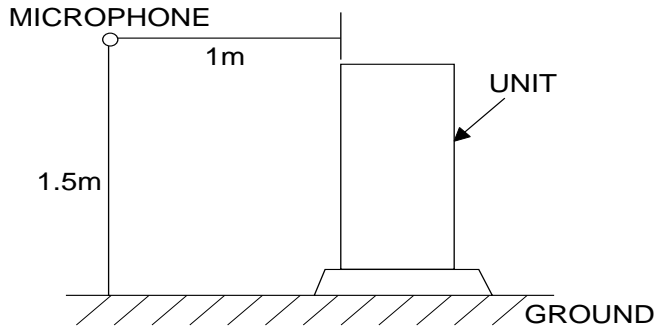

PUHZ-RP3VHA

MODE	SPL(dB)	LINE
COOLING	47	○—○
HEATING	48	●—●

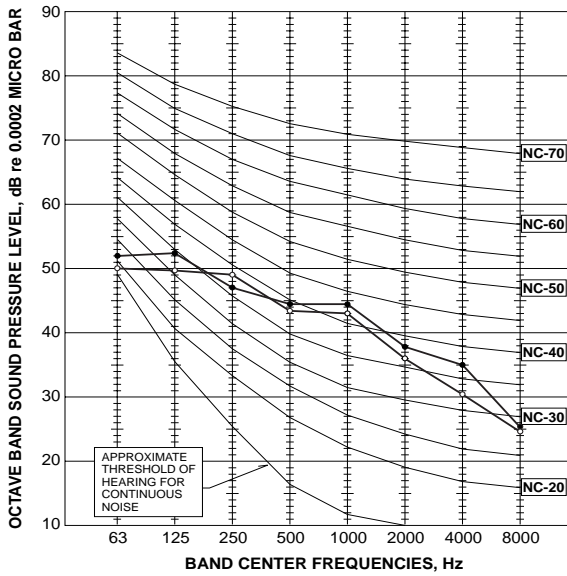

PUHZ-RP4VHA

MODE	SPL(dB)	LINE
COOLING	49	○—○
HEATING	50	●—●

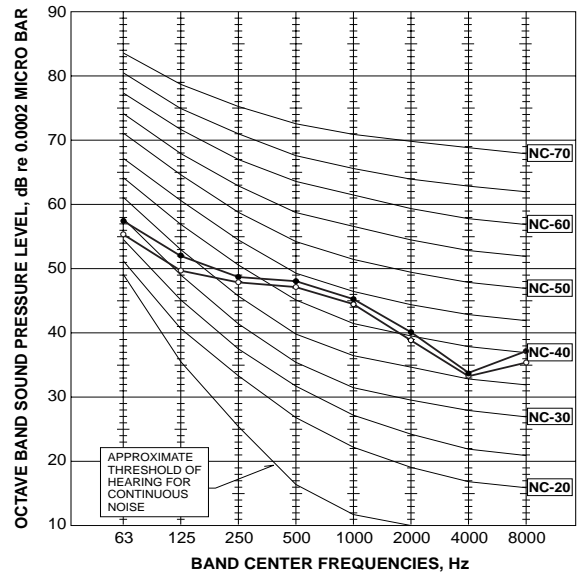

PUHZ-RP5VHA
PUHZ-RP6VHA

MODE	SPL(dB)	LINE
COOLING	50	○—○
HEATING	52	●—●

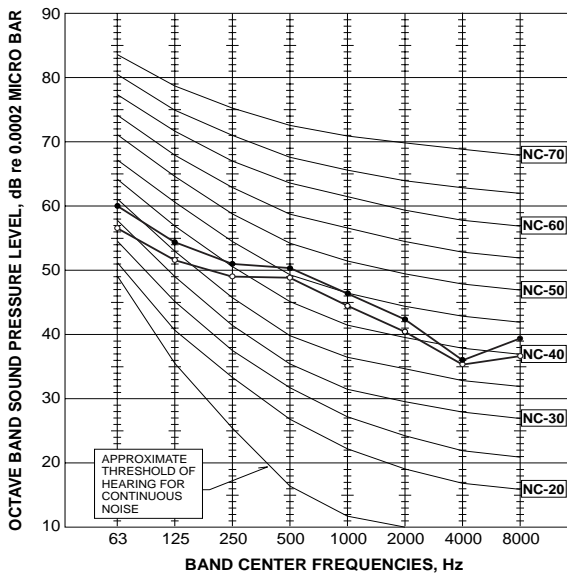

**PUHZ-RP4VHA
PUHZ-RP5VHA
PUHZ-RP6VHA**

Unit : mm

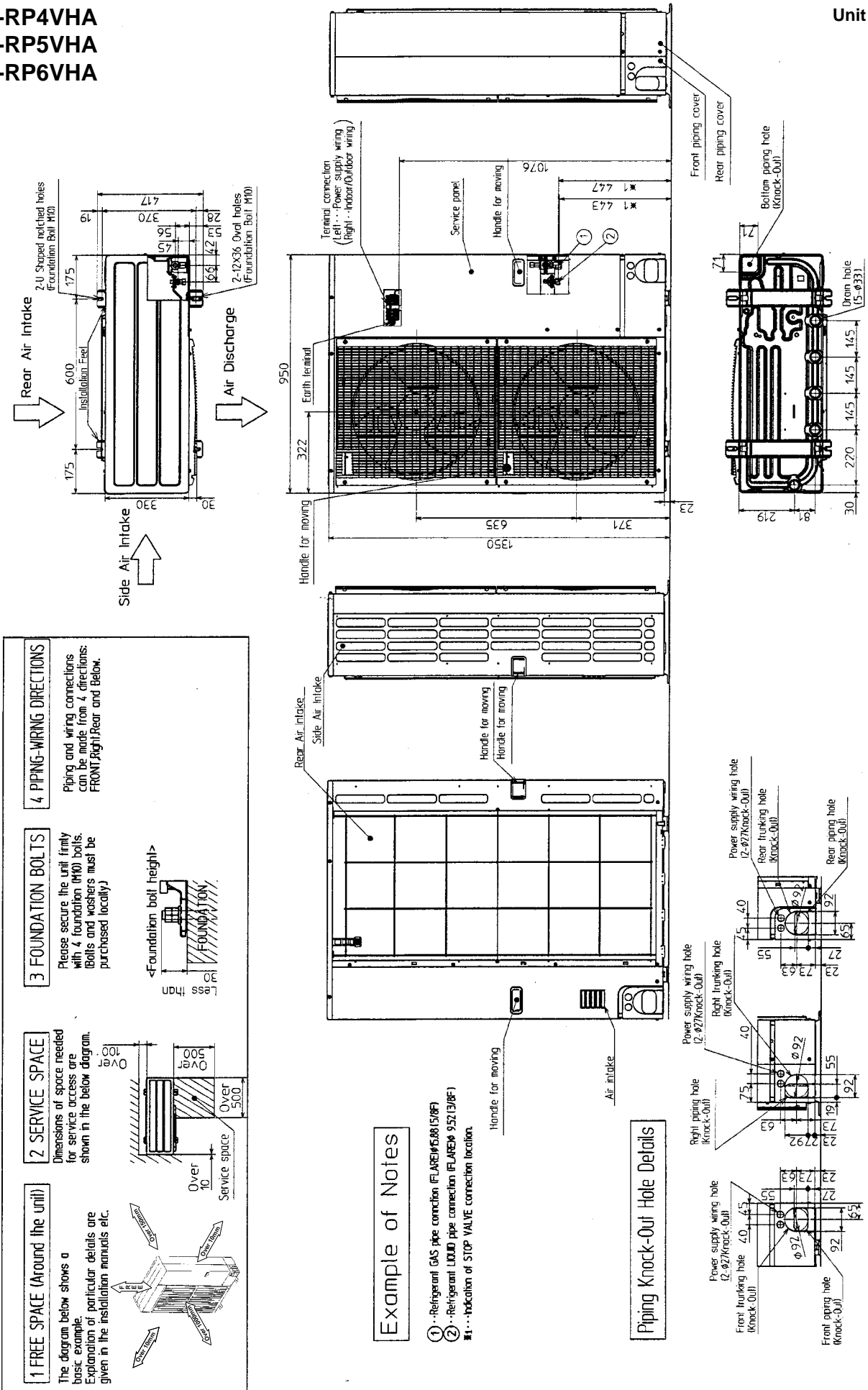

4 PIPING-WIRING DIRECTIONS

Piping and wiring connections can be made from 4 directions: **FRONT, Right, Rear and Below.**

3 FOUNDATION BOLTS

Please secure the unit firmly with 4 foundation (M10) bolts. (Bolts and washers must be purchased locally.)

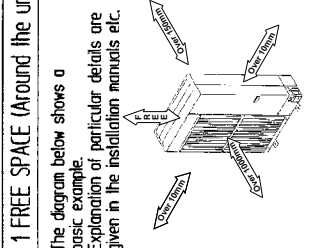

2 SERVICE SPACE

Dimensions of space needed for service access are shown in the below diagram.

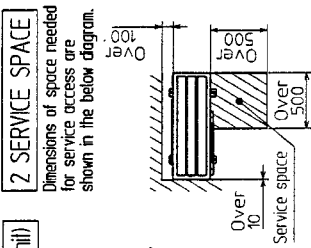

1 FREE SPACE (Around the unit)

The diagram below shows a basic example. Explanation of particular details are given in the installation manuals etc.

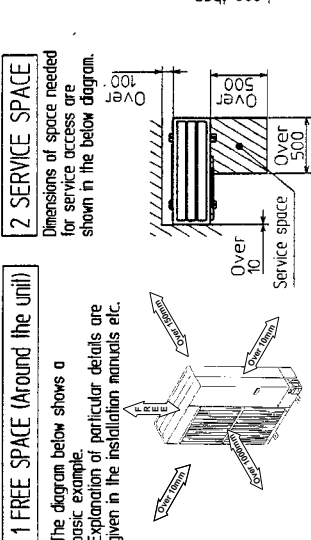

Example of Notes

- ① -Refrigerant GAS pipe connection (FLARE) (R5.88.15/8F)
- ② -Refrigerant LIQUID pipe connection (FLARE) (R5.92.13/8F)
- 1 ... indication of STOP VALVE connection location.

Piping Knock-Out Hole Details

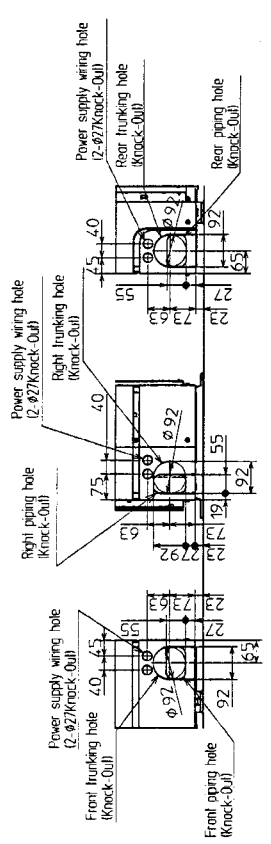

PUHZ-RP3VHA

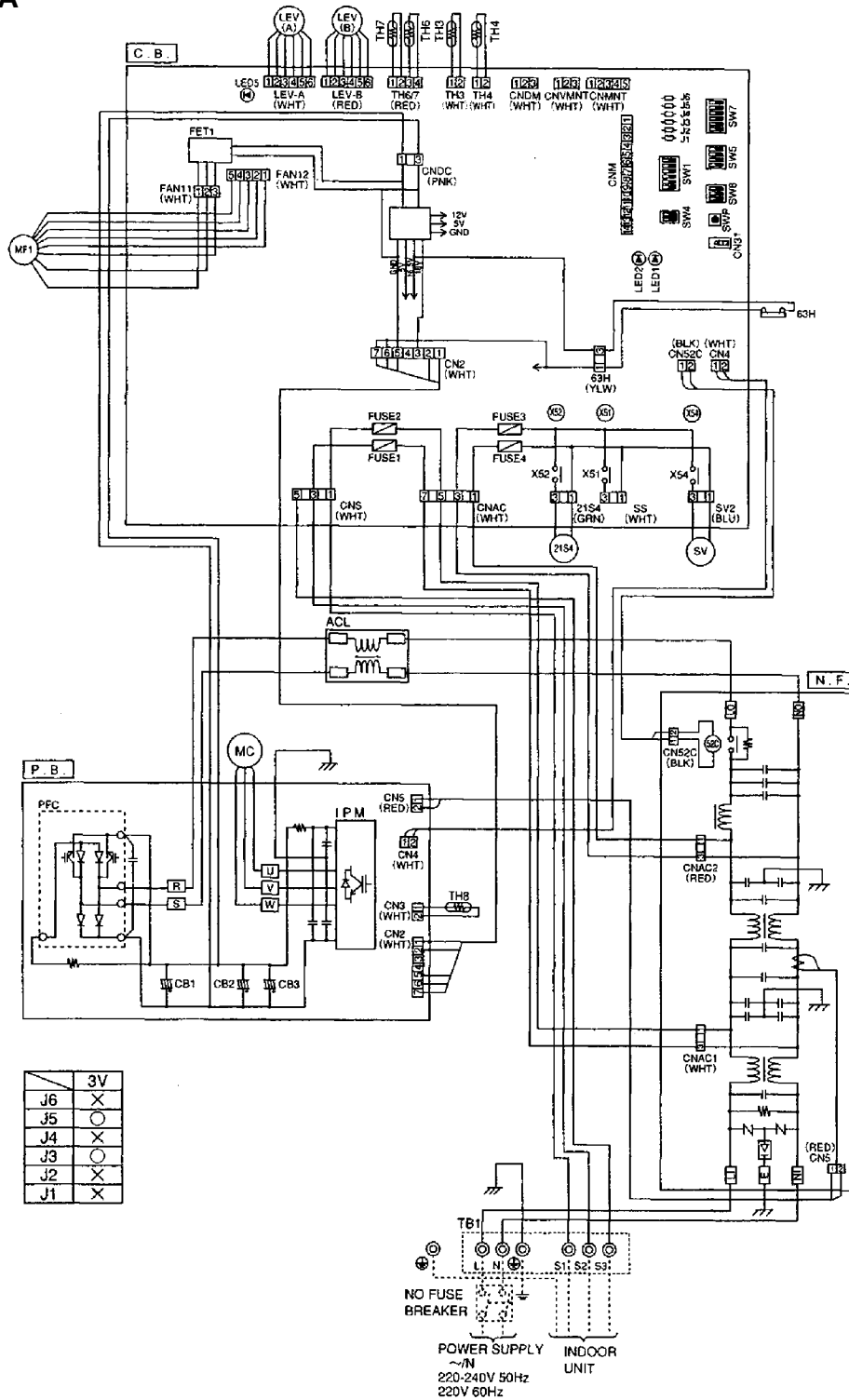

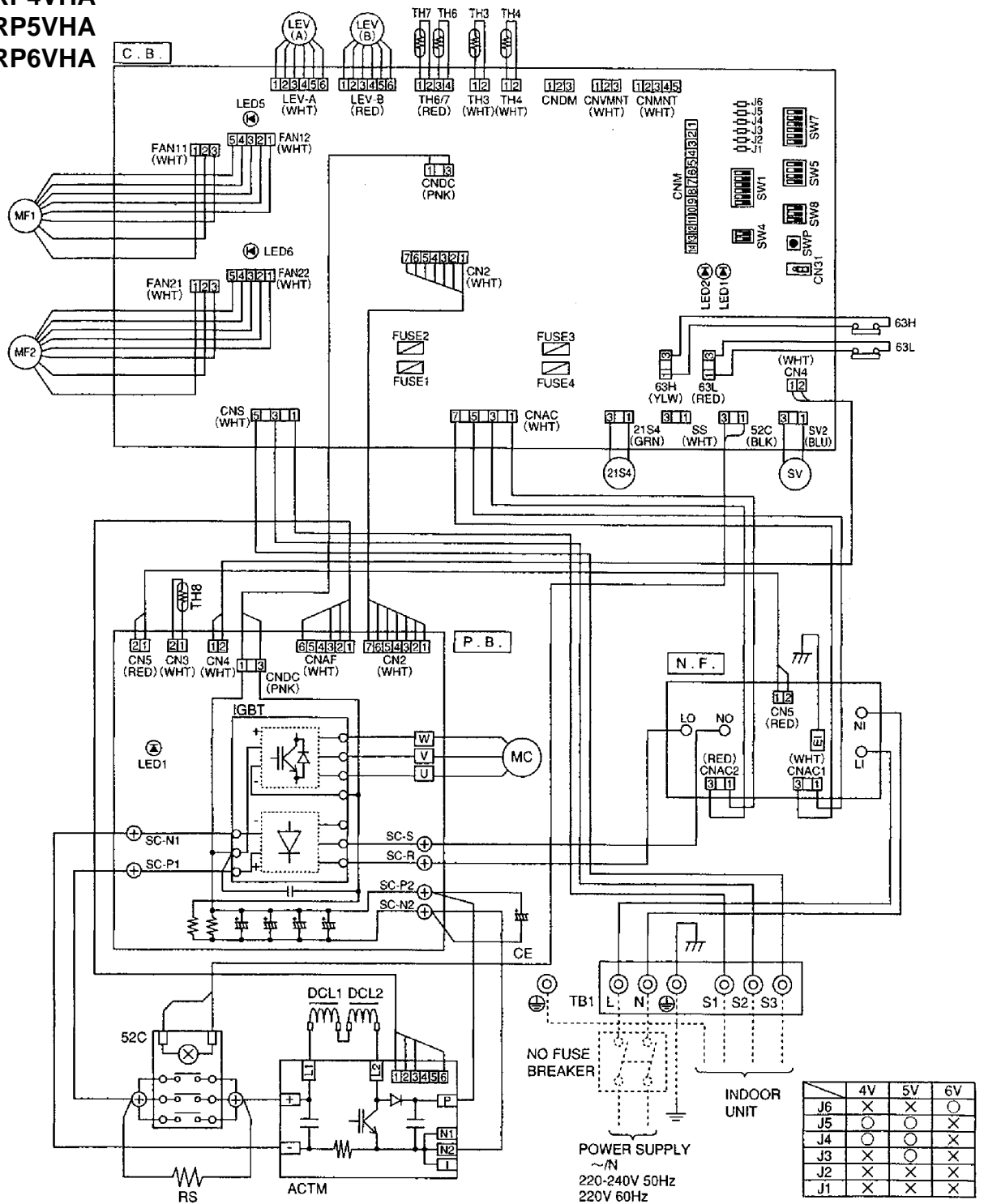

SYMBOL	NAME	SYMBOL	NAME	SYMBOL	NAME
TB1	Terminal Block (Power Supply, Indoor/Outdoor)	N.F.	Noise Filter Circuit Board	J1-J6	Jumpers (Model Setup)
MC	Motor for Compressor	L1/L0	Connection Terminal (L-Phase)	SWP	Switch (Pump Down)
MF1	Fan Motors	N1/N0	Connection Terminal (N-Phase)	CN31	Connector (Emergency Operation)
21S4	Solenoid Valve (Four-Way Valve)	E	Connection Terminal (Ground)	CNAC	Connector
63H	High Pressure Switch	CNAC1/2	Connector	CNDC	Connector
SV	Solenoid Valve (Bypass Valve)	CN5	Connector	CNS	Connector
TH3	Thermistor (Outdoor Pipe)	CN52C	52C Relay	FAN11	Connector
TH4	Thermistor (Discharge)	C5C	52C Relay	FAN12	Connector
TH6	Thermistor (Outdoor 2-Phase Pipe)	C.B.	Controller Circuit Board	SS	Connector (Connection for Option)
TH7	Thermistor (Outdoor)	FUSE1~4	Fuse (6.3 A)	SV2	Connector
TH8	Thermistor (Heat sink)	SW1	Switch (Forced Defrost, Defect History Record Reset, Refrigerant Address)	CNM	Connector (A-Control Service Inspection Kit)
LEV(A),LEV(B)	Electronic Expansion Valve	SW4	Switch (Test Operation)	CNMNT	Connector (Connected to Optional M-NET Adapter Board)
ACL	Reactors	SW5	Switch (Function Switch)	CNVMNT	Connector (Connected to Optional M-NET Adapter Board)
P.B.	Power Circuit Board	SW7	Switch (Function Setup)	CNDM	Connector (Connected for Option (Contact Input))
R/S	Connection Terminal (L/N-Phase)	SW8	Switch	X51,X52,X54	Relay
U/V/W	Connection Terminal (U/V/W-Phase)	LED1,LED2	Light Emitting Diodes (Operation Inspection Indicators)	FET1	MF1 Drive Element
CN2~5	Connector	LED5	Light Emitting Diodes (MF1 Operation Status Indicators)		
PFC	Converter				
IPM	Inverter				
CB1~CB3	Main Smoothing Capacitor				

PUHZ-RP4VHA
 PUHZ-RP5VHA
 PUHZ-RP6VHA

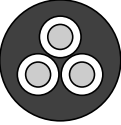
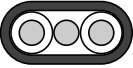

SYMBOL	NAME	SYMBOL	NAME	SYMBOL	NAME
TB1	Terminal Block (Power Supply, Indoor/Outdoor)	SC-R/S	Screw Type Terminal (L/N-Phase)	SW8	Switch
MC	Motor for Compressor	SC-P1, P2	Screw Type Terminal (DC Voltage)	J1-J6	Jumpers (Model Setup)
MF1, MF2	Fan Motors	SC-N1, N2	Screw Type Terminal (DC Voltage)	SWP	Switch (Pump Down)
21S4	Solenoid Valve (Four-Way Valve)	CN2~5	Connector	CN31	Connector (Emergency Operation)
SV	Solenoid Valve (Bypass Valve)	CNDC	Connector	LED1, LED2	Light Emitting Diodes (Operation Inspection Indicators)
63H	High Pressure Switch	CNAF	Connector	LED5/6	Light Emitting Diodes (MF1/MF2 Operation Status Indicators)
63L	Low Pressure Switch	IGBT	Converter, Inverter	CNAC	Connector
TH3	Thermistor (Outdoor Pipe)	LED1	Light Emitting Diodes (Inverter Control Status)	CNDC	Connector
TH4	Thermistor (Discharge)	N.F.	Noise Filter Circuit Board	CNS	Connector
TH6	Thermistor (Outdoor 2-Phase Pipe)	LI/LO	Connection Lead (L-Phase)	FAN11	Connector
TH7	Thermistor (Outdoor)	NI/NO	Connection Lead (N-Phase)	FAN12	Connector
TH8	Thermistor (Heat sink)	E1	Connection Terminal (Ground)	FAN21	Connector
LEV(A), LEV(B)	Electronic Expansion Valve	CNAC1/2	Connector	FAN22	Connector
DCL1, DCL2	Reactors	CN5	Connector	SS	Connector (Connection for Option)
52C	52C Relay	C.B.	Controller Circuit Board	SV2	Connector
RS	Rush Current Protect Resistor	FUSE1~4	Fuse (6.3 A)	CNM	Connector (A-Control Service Inspection Kit)
ACTM	Active Filter Module	SW1	Switch (Forced Defrost, Defect History Record Reset, Refrigerant Address)	CNMNT	Connector (Connected to Optional M-NET Adapter Board)
CE	Main Smoothing Capacitor	SW4	Switch (Test Operation)	CNVMNT	Connector (Connected to Optional M-NET Adapter Board)
P.B.	Power Circuit Board	SW5	Switch (Function Switch)	CNDM	Connector (Connected for Option (Contact Input))
U/V/W	Connection Terminal (U/V/W-Phase)	SW7	Switch (Function Setup)		

**WIRING SPECIFICATIONS FOR 220~240V 50Hz
(INDOOR-OUTDOOR CONNECTING CABLE)**

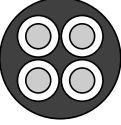
Cross section of cable	Wire size (mm ²)	Number of wires	Polarity	L(m) *6
Round 	2.5	3	Clockwise : S1-S2-S3 * Pay attention to stripe of yellow and green	(50) *2
Flat 	2.5	3	Not applicable (Because center wire has no cover finish)	Not applicable *5
Flat 	1.5	4	From left to right : S1-Open-S2-S3	(45) *3
Round 	2.5	4	Clockwise : S1-S2-S3-Open * Connect S1 and S3 to the opposite angle	60 *4

*1 : Power supply cords of appliances shall not be lighter than design 245 IEC or 227 IEC.

*2 : In case that cable with stripe of yellow and green is available.

*3 : In case of regular polarity connection (S1-S2-S3), wire size is 1.5mm².

*4 : In case of regular polarity connection (S1-S2-S3).

*5 : In the flat cables are connected as this picture, they can be used up to 80m.

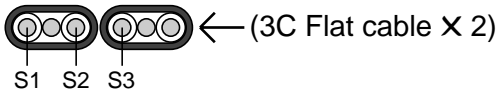

*6 : Mentioned cable length is just a reference value.

It may be different depending on the condition of installation, humidity or materials, etc.

PUHZ-RP3VHA

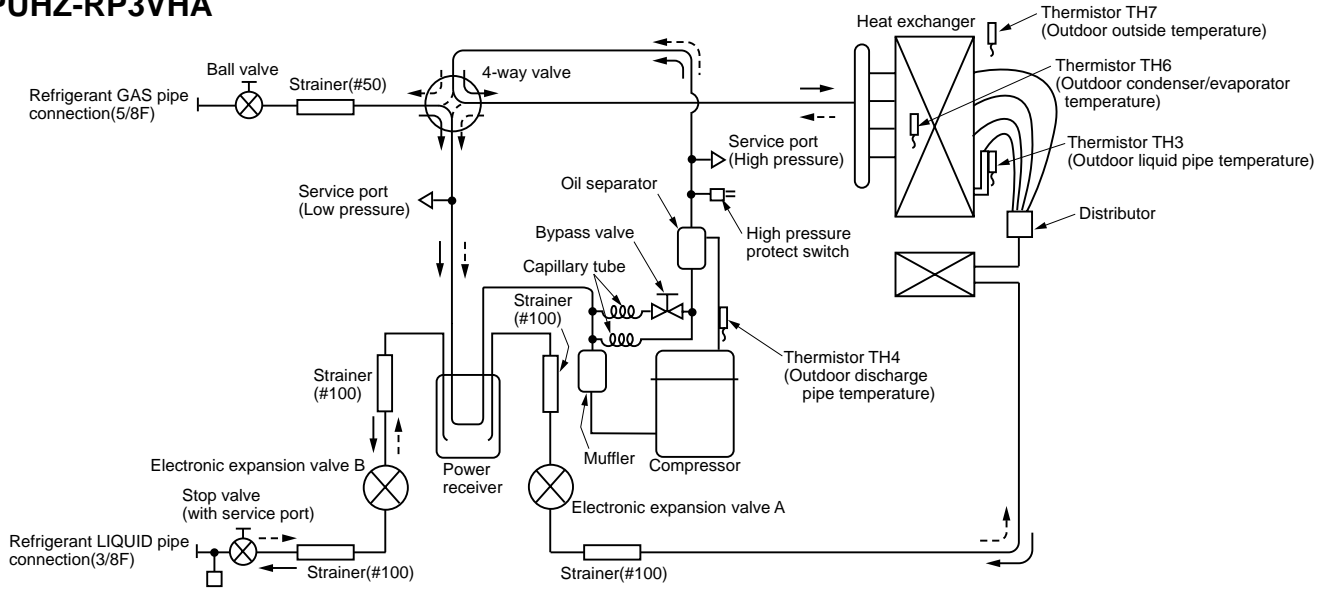

**PUHZ-RP4VHA
PUHZ-RP5VHA
PUHZ-RP6VHA**

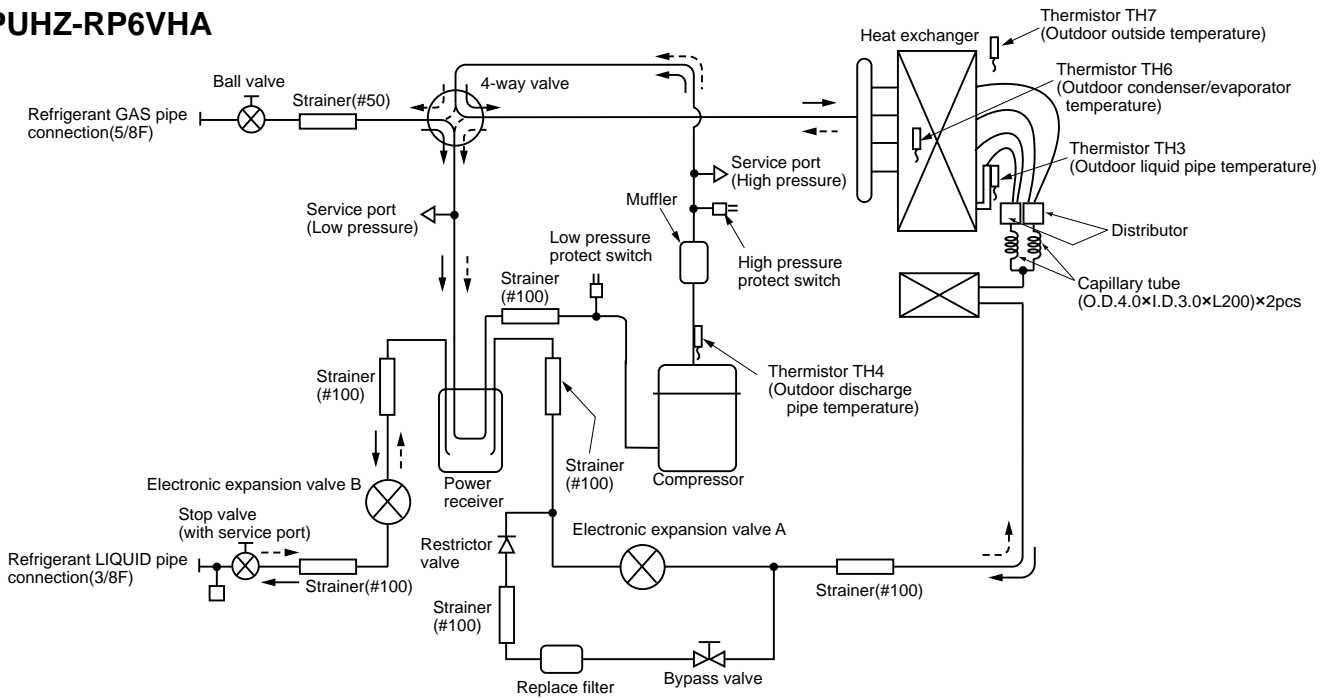

Applicable extension pipe for each model

(1) 1:1 system

(a) Pipe length

<Table 1> Pipe length for 1:1 system

Liquid pipe (mm)	OD	φ6.35			φ9.52			φ12.7	
	Thick-ness	t0.8			t0.8			t0.8	
Gas pipe (mm)	OD	φ9.52	φ12.7	φ15.88	φ12.7	φ15.88	φ19.05	φ15.88	φ19.05
	Thick-ness	t0.8	t0.8	t1.0	t0.8	t1.0	t1.0	t1.0	t1.0
RP3	×	□ 10m	○ 10m		□ 30m	◎ 50m	×	△ 30m	×
RP4	×	×	×	×	×	◎ 75m (*2)	○ 50m (*1)	△ 50m	△ 50m (*1)
RP5	×	×	×	×	×	◎ 75m (*2)	○ 50m (*1)	△ 50m	△ 50m (*1)
RP6	×	×	×	×	×	◎ 75m (*2)	○ 50m (*1)	△ 50m	△ 50m (*1)

*1: Set DIP SW8-1 on outdoor unit controller board to ON.

*2: The maximum length is 50 m in case of using existing pipes.

*3: The height difference between indoor and outdoor unit should be kept within 30 m for all models.

[Marks in the table above]

◎ : Normal piping

△ : It can be used, however, additional refrigerant charge is required when the pipe length exceeds 20m. ➡ Refer to table 4.

× : It cannot be used.

○ : It can be used.

□ : It can be used, however, the capacity is lowered. ➡ Refer to (C) Capacity correction.

(b) Adjusting the amount of refrigerant

- Additional refrigerant charge is not necessary for the pipe length up to 30 m. When the pipe length exceeds 30 m or service (refrigerant replacement) is performed, charge proper amount of refrigerant for each pipe length referring to table below. Use refrigerant R410A. Use charge hose exclusive for R410A.
- When charging additional refrigerant, charge the refrigerant from low-pressure side of the port valve using a safety charger.
- Make sure that air purge for this unit at refrigerant replacement is performed from both high-pressure check valve and service port. (If air purge is performed only from one of them, air in not purged enough.)
- When replacing refrigerant, charge the refrigerant from service port. When charged refrigerant is less than specified amount, charge the refrigerant again from low pressure side of the port valve using a safety charger.
- Tighten the service port cap (nut) of stop valve firmly. The tightening torque is 12 to 16 N·m. (For the prevention of slow-leak)
- Check additional refrigerant charging amount referring to table 4 when liquid pipe is one size larger than standard diameter, and table 2 when the pipe is standard diameter.

<Table 2> Additional refrigerant charging amount for pipe of standard diameter

Outdoor unit	Permitted pipe length	Additional refrigerant charging amount for pipe length exceeding 30 m (kg)				Number of bends	Height difference
		31 — 40m	41 — 50m	51 — 60m	61 — 75m		
PUHZ-RP3V	50m or below	0.6Kg	1.2Kg	—	—	15	30m or above
PUHZ-RP4V — RP6V	75m or below	0.6kg	1.2kg	1.8kg	2.4kg		

<Table 3>

Outdoor unit	Permitted pipe length	Additional refrigerant charging amount for recharging (above) and pipe length exceeding 30m (below) (kg)						
		10m or below	11 — 20m	21 — 30m	31 — 40m	41 — 50m	51 — 60m	61 — 75m
PUHZ-RP3V	50m or below	3.1	3.3	3.5	4.1	4.7	—	—
					0.6	1.2	—	—
PUHZ-RP4V — RP6V	75m or below	5.1	5.3	5.5	6.1	6.7	7.3	7.9
					0.6	1.2	1.8	2.4

<Table 4> Additional refrigerant charging amount for liquid pipe which is one size larger than standard diameter

	Liquid pipe dia	Chargeless	Max. pipe length	Additional refrigerant charging amount
RP3	φ12.7	20m	30m	100 g addition per 1 m when pipe length exceeds 20 m
RP4 — RP6	φ12.7	20m	50m	100 g addition per 1 m when pipe length exceeds 20 m

(C) Capacity correction

Cooling and heating capacity is lowered according to pipe length. Capacity can be obtained by referring to the capacity curves below. When the diameter of gas pipe is one size smaller than standard diameter, cooling capacity is lowered comparing to the standard diameter. The lowered capacity can be obtained by referring to capacity curves for gas pipe which is one size smaller than standard size.

$$\text{Corrected pipe length (m)} = \text{actual pipe length (m)} + \text{number of bends} \times 0.3 \text{ (m)}$$

① Capacity curves for PUHZ-RP • VHA model <Standard size>

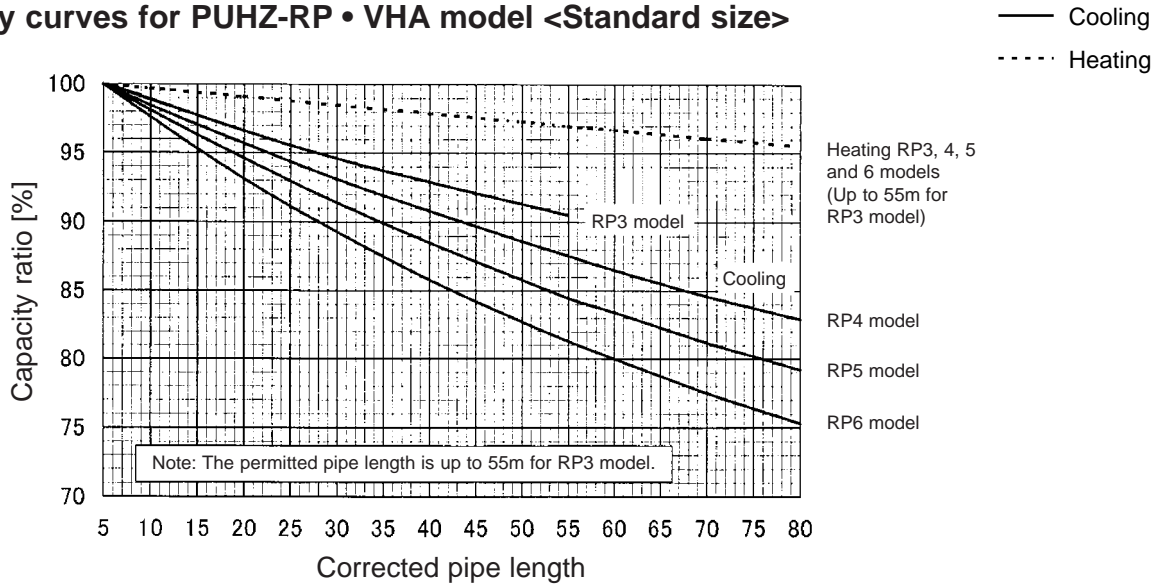

② Capacity curve for PUHZ-RP3V model <When gas pipe is one size smaller than standard size>

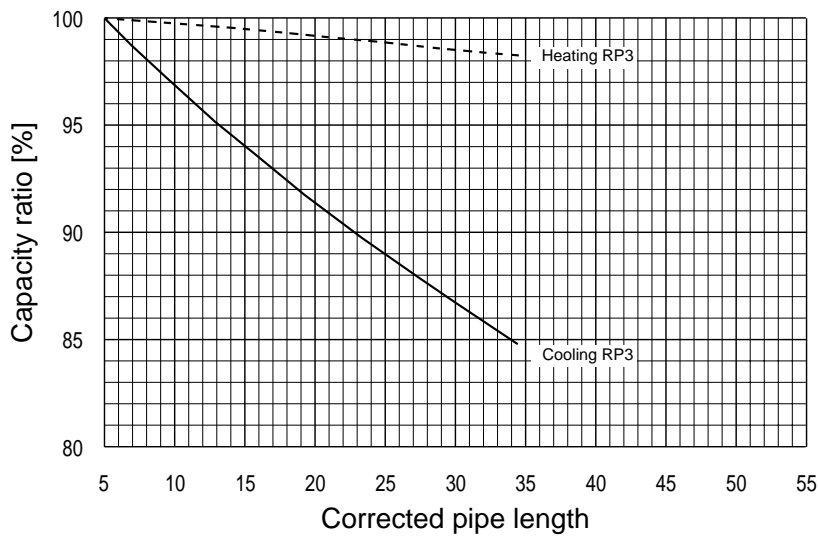

③ When gas pipe is one size larger than standard size for PUHZ-RP4, 5 and 6.

① Capacity can be obtained by referring to capacity curves of standard size.

1. Refrigerant collecting (pump down)

Perform the following procedures to collect the refrigerant when moving the indoor unit or the outdoor unit.

- ① Before collecting the refrigerant, first make sure that all of the SW5 DIP switches for function changes on the control board of the outdoor unit are set to OFF. If all of the SW5 switches are not set to OFF, record the settings and then set all of the switches to OFF. Now, start refrigerant collecting operation. After moving the unit to a new location and completing the test run, set the SW5 switches to the previously recorded settings.
- ② Turn on the power supply (circuit breaker).
 - *When power is supplied, make sure that “CENTRALLY CONTROLLED” is not displayed on the remote controller. If “CENTRALLY CONTROLLED” is displayed, the refrigerant collecting (pump down) cannot be completed normally.
- ③ After the liquid stop valve is closed, set the SWP switch on the control board of the outdoor unit to ON. The compressor (outdoor unit) and ventilators (indoor and outdoor units) start operating and refrigerant collecting operation begins. LED1 and LED2 on the control board of the outdoor unit are lit.
 - *Set the SWP switch (push-button type) to ON in order to perform refrigerant collecting operation only when the unit is stopped. However, refrigerant collecting operation cannot be performed until compressor stops even if the unit is stopped. Wait three minutes until compressor stops and set the SWP switch to ON again.
- ④ Because the unit automatically stops in about two to three minutes after the refrigerant collecting operation (LED1 is not lit and LED2 is lit), be sure to quickly close the gas stop valve.
 - *In case the outdoor unit is stopped when LED1 is lit and LED2 is not lit, open the liquid stop valve completely, and then repeat step ③ three minutes later.
 - *If the refrigerant collecting operation has been completed normally (LED1 is not lit and LED2 is lit), the unit will remain stopped until the power supply is turned off.
- ⑤ Turn off the power supply (circuit breaker.)

2. Unit replacement operation

When reusing the existing pipes that carried R22 refrigerant for the RP4, RP5 and RP6 models, replacement operation must be performed before performing a test run.

- ① If new pipes are used, these procedures are not necessary.
 - ② If existing pipes that carried R22 refrigerant are used for the RP3 model, these procedures are not necessary. (The replacement operation cannot be performed.)
 - ③ During replacement operation, “C5” is displayed on “A-Control Service Tool(PAC-SK52ST)”. (This is applied to only RP4, RP5 and RP6 models.)
- Replacement operation procedures
- ① Turn on the power supply.
 - ② Set DIP switch SW8-2 on the control board of the outdoor unit to ON to start replacement operation.
 - The replacement operation is performed using the cooling system. Cool air will flow from the indoor unit during the replacement operation.
 - During the replacement operation, **TEST RUN** is displayed on the remote controller and LED1 (green) and LED2 (red) on the control board of the outdoor unit flash together.
 - ③ Replacement operation requires at least two hours to complete.
 - After setting switch SW8-2 to ON, the unit automatically stops after two hours.
 - Replacement operation can be performed repeatedly by setting switch SW8-2 from OFF to ON. Make sure to perform the operation more than 2 hours. (If the operation is performed less than 2 hours, the existing pipes cannot be cleaned enough and the unit may be damaged.)
 - If replacement operation is performed over 2 hours, this action is recorded into nonvolatile memory of control board.
 - ④ Set switch SW8-2 to OFF. (Replacement operation is completed.)
 - *The unit can be operated normally by remote controller even if SW8-2 remains ON.
 - *If the indoor temperature is less than 15°C, the compressor will operate intermittently but the unit is not faulty.

3. Start and finish of test run

- Operation from the indoor unit
Execute the test run using the installation manual for the indoor unit.
- Operation from the outdoor unit
By using the DIP switch SW4 on the control board of outdoor unit, test run can be started and finished, and its operation mode (cooling/heating) can be set up.
 - ① Set the operation mode (cooling/heating) using SW4-2.
 - ② Turn on SW4-1 to start test run with the operation mode set by SW4-2.
 - ③ Turn off SW4-1 to finish the test run.

- There may be a faint knocking sound around the machine room after power is supplied, but this is no problem with product because the linear expansion pipe is just moving to adjust opening pulse.
- There may be a knocking sound around the machine room for several seconds after compressor starts operating, but this is no problem with product because the check valve, itself, generates the sound because pressure difference is small in the refrigerant circuit.

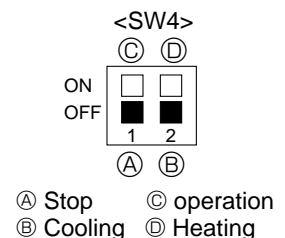

Note:
The operation mode cannot be changed by SW4-2 during test run. (To change test run mode, stop the unit by SW4-1, change the operation mode and restart the test run by SW4-1.)

10-1. TROUBLESHOOTING

<Error code display by self-diagnosis and actions to be taken for service (summary)>

Present and past error codes are logged and displayed on the wired remote controller and control board of outdoor unit.

Actions to be taken for service, which depends on whether or not the inferior phenomenon is reoccurring at service, are summarized in the table below. Check the contents below before investigating details.

Unit conditions at service	Error code	Actions to be taken for service (summary)
The inferior phenomenon is reoccurring.	Displayed	Judge what is wrong and take a corrective action according to "Self-diagnosis action table" (P.28).
	Not displayed	Conduct trouble shooting and ascertain the cause of the inferior phenomenon according to "Troubleshooting by inferior phenomena" (P.37).
The inferior phenomenon is not reoccurring.	Logged	<ul style="list-style-type: none"> ①Consider the temporary defects such as the work of protection devices in the refrigerant circuit including compressor, poor connection of wiring, noise and etc. Re-check the symptom, and check the installation environment, refrigerant amount, weather when the inferior phenomenon occurred, matters related to wiring and etc. ②Reset error code logs and restart the unit after finishing service. ③There is no abnormality concerning of parts such as electrical component, controller board, remote controller and etc.
	Not logged	<ul style="list-style-type: none"> ①Re-check the abnormal symptom. ②Conduct trouble shooting and ascertain the cause of the inferior phenomenon according to "Troubleshooting by inferior phenomena" (P.37). ③Continue to operate unit for the time being if the cause is not ascertained. ④There is no abnormality concerning of parts such as electrical component, controller board, remote controller and etc.

10-2. Check point under test run (MA remote controller)

(1) Before test run

- After installation of indoor and outdoor units, piping work and electric wiring work, re-check that there is no refrigerant leakage, loosened connections and incorrect polarity.
 - Measure impedance between the ground and the power supply terminal block(L, N) on the outdoor unit by 500V Merger and check that it is 1.0MΩ or over.
 - ※Don't use 500V Merger to indoor/outdoor connecting wire terminal block(S1, S2, S3) and remote controller terminal block (1, 2). This may cause malfunction.
 - Make sure that test run switch (SW4) is set to OFF before turning on power supply.
 - Make sure that all of the SW5 switches for function changes on the control board of the outdoor unit are set to OFF. If all of the SW5 switches are not set to OFF, record the settings and then set all of the switches to OFF. And perform emergency operation. After finishing emergency operation, set the SW5 switches to the recorded settings.
 - Turn on power supply twelve hours before test run in order to protect compressor.
 - For specific models which requires higher ceiling settings or auto-recovery feature from power failure, make proper changes of settings referring to the description of "Selection of Functions through Remote Controller".
- Make sure to read operation manual before test run. (Especially items to secure safety.)

10-2-1. Test run by remote controller

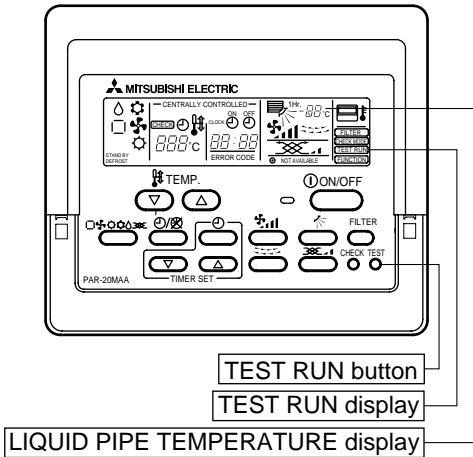

Operating procedures	
1. Turn on the main power supply.	While the room temperature display on the remote controller is "H0", the remote controller is disabled. Wait until "H0" disappears before using remote controller. "H0" appears for about 2 minutes after power supply is turned on. *1
2. Press TEST RUN button twice.	The TEST RUN appears on the screen.
3. Press OPERATION SWITCH button.	Cooling mode: Check if cool air blows and water is drained. Heating mode: Check if warm air blows. (It takes a little while until warm air blows.)
4. Press AIR DIRECTION button.	Check for correct motion of auto-vanes.
5. Check the outdoor unit fan for correct running.	The outdoor unit features automatic capacity control to provide optimum fan speeds. Therefore, the fan keeps running at a low speed to meet the current outside air condition unless it exceeds its available maximum power. Then, in actuality, the fan may stop or run in the reverse direction depending on the outside air, but this does not mean malfunction.
6. Press the ON/OFF button to reset the test run in progress.	
7. Turn off the main power supply.	

- In case of test run, the OFF timer will be activated, and the test run will automatically stop after two hours.
- The room temperature display section shows the pipe temperature of indoor units during the test run.
- Check that all the indoor units are running properly in case of simultaneous twin and triple operation. Malfunctions may not be displayed regardless of incorrect wiring.
- ※1 After turning on the power supply, the system will go into startup mode, "H0" will blink on the display section of the room temperature, and lamp(red) of the remote controller will flash.
As to INDOOR BOARD LED, LED1 and LED2 will be lit up in case the address is 0, or turned off in case the address is not 0. LED3 will blink.
As to OUTDOOR BOARD LED, LED1(green) and LED2(red) will light up. (After the startup mode of the system finishes, LED2(red) will be turned off.)
In case OUTDOOR BOARD LED is digital display, and will be displayed alternately every second.
- If one of the above operations doesn't function correctly, the causes written below should be considered. Find causes from the symptoms.
The below symptoms are under test run mode. "startup" in the table means the display status of *1 written above.

Symptoms in test run mode		Cause
Remote Controller Display	OUTDOOR BOARD LED Display < > indicates digital display.	
Remote controller displays "H0", and cannot be operated.	After "startup" is displayed, only green lights up. <00>	• After power is turned on, "H0" is displayed for 2 minutes during system startup. (Normal)
After power is turned on, "H0" is displayed for 3 minutes, then error code is displayed.	After "startup" is displayed, green(once) and red(once) blink alternately. <F1> After "startup" is displayed, green(once) and red(twice) blink alternately. <F3, F4, F9>	• Incorrect connection of outdoor terminal block (L, N and S1, S2, S3.) • Outdoor unit's safeguard installation connector is open.
No display appears even when remote controller operation switch is turned on. (Operation lamp does not light up.)	After "startup" is displayed, green(twice) and red(once) blink alternately. <EA, Eb> After "startup" is displayed, only green lights up. <00>	• Incorrect wiring between the indoor and outdoor unit (Polarity is wrong for S1, S2, S3.) • Remote controller transmission wire short. • There is no outdoor unit of address 0. (Address is other than 0.) • Remote controller transmission wire burnout.
Display appears but soon disappears even when remote controller is operated.	After "startup" is displayed, only green lights up. <00>	• After canceling function selection, operation is not possible for about 30 seconds. (Normal)

※Press the remote controller's **CHECK** button twice to perform self-diagnosis. See the table below for the contents of LCD display.

LCD	Contents of inferior phenomena	LCD	Contents of inferior phenomena
P1	Abnormality of room temperature thermistor	U1~UP	Malfunction outdoor unit
P2	Abnormality of pipe temperature thermistor/Liquid	F3~F9	Malfunction outdoor unit
P4	Abnormality of drain sensor	E0~E5	Remote controller transmitting error
P5	Drain overflow protection is working.	E6~EF	Indoor/outdoor unit communication error
P6	Freezing/overheating protection is working.	----	No error history
P8	Abnormality of pipe temperature	FFFF	No applied unit
P9	Abnormality of pipe temperature thermistor/Cond./Eva		

See the table below for details of the LED display (LED 1, 2, 3) on the indoor controller board.

LED1 (microcomputer power supply)	Lits when power is supplied.
LED2 (remote controller)	Remote controller The indoor unit should be connected to the outdoor unit with address "0" setting.
LED3 (indoor/outdoor communication)	Flash when indoor and outdoor unit are communicating.

10-2-2. Test run by outdoor unit SW4

The setting of test run (ON/OFF) and its operation mode (cooling/heating) can be set by SW4 on the controller board of outdoor unit. Check that SW5-1 is set to OFF before performing test run. If SW5-1 is set to ON, turn it OFF and then perform test run. After finishing test run, set SW5-1 back to ON.

- ①Set operation mode(cooling or heating) by SW4-2.
- ②Start test run by setting SW4-1 to ON (⤴) with the indicated operation mode of SW4-2.
- ③Finish test run by setting SW4-1 to OFF (⤵).
 - Operation mode cannot be changed by SW4-2 during test run.
 - Stop test run to change operation mode by SW4-1, and restart test run by SW4-1 after the mode is changed.
 - Test run automatically stops 2 hours later by 2-hour OFF timer function.
 - Test run can be performed by the remote controller.
 - The remote controller display of test run by outdoor unit is the same as that of test run by remote controller.

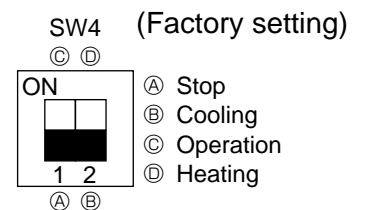

10-3. Malfunction-diagnosis method by remote controller

10-3-1. Error history of unit

(1) Wired remote controller

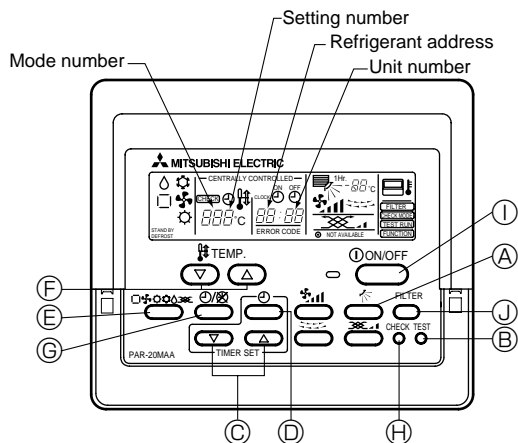

<In case of trouble during operation>

If there is a trouble on air conditioner, both indoor unit and outdoor unit will stop and digital display shows what was wrong.

- ① “CHECK” and refrigerant address are displayed at set temperature display. Error code and unit number are displayed at clock display alternately.
(If outdoor unit is malfunctioning, unit number is 00.)
- ② The refrigerant address and error code initially sent from the unit are displayed in case of group control system which one remote controller controls plural refrigerant systems.
- ③ Press the “ON/OFF” button to cancel error code.
In case of central control by the controller of MELANS, cancel the error code by the controller of the MELANS, and in case of distant-handly combined operation, cancel the error code by canceling distant operation.

<Malfunction-diagnosis method at maintenance service>

Digital control has memory function that memorizes latest error code even if it is cancelled by remote controller or power is shut off, so error histories can be searched by following the procedure below.

Search error histories of each unit by remote controller.

- ① Turn to self-diagnosis mode.
Press the ⊕ “CHECK” button twice within three seconds, and following display appears.
a) Refrigerant address for self-diagnosis
- ② Set refrigerant address number that you want to diagnose.
Press the ⊕ ⊖ ⊕ (temp.) button to set refrigerant address to be diagnosed.
Refrigerant address has number from 00 to 15.
Three seconds after setting, lighted self-diagnosed refrigerant address begins blinking and self-diagnosis process begins.
- ③ Self-diagnosis result display
 - (1) When there is an error history. (Refer to page 28 to 36 for details of error code contents.)
 - a) Alternating display
 - b) Error code
 - c) Attribute of error search
 - d) Unit number
 - e) Unit number
 - (2) When there is no error history.
 - (3) When the address does not exist.

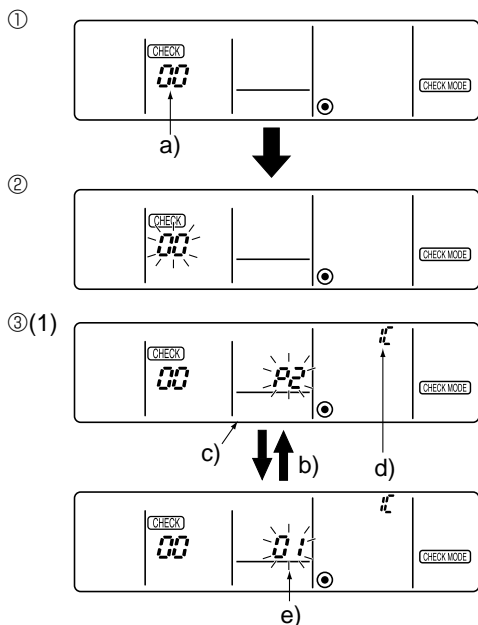

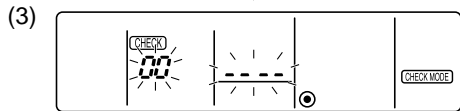
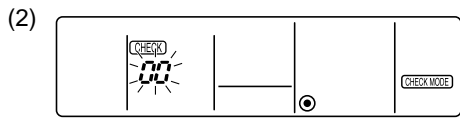
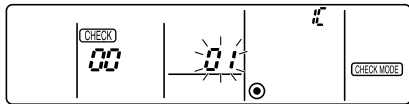
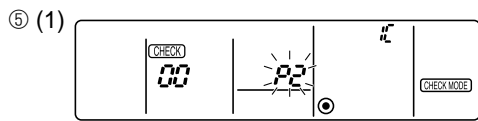
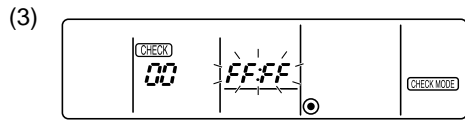
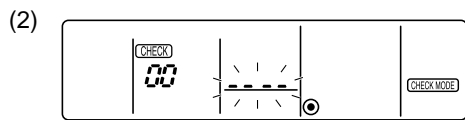

④ To cancel self-diagnosis

There are following two methods to cancel self-diagnosis:
Press the ⊕ "CHECK" button twice within three seconds.
→Self-diagnosis is cancelled and the display screen will return to the status before self-diagnosis.

Press the Ⓛ "ON/OFF" button.

→Self-diagnosis is cancelled and indoor unit will stop.

This operation is ineffectual when the operation of remote controller is prohibited.

During self-diagnosis at maintenance service, all the indoor units start performing fan operation except for the indoor unit indicating the latest error. Then outdoor units of the same refrigerant system also start performing fan operation intermittently for 3 minutes. (The fan is on for 3 seconds and then off for 5 seconds.)

The unit with error can be inspected by using this. In case unit other than indoor unit, such as outdoor unit and controller of MELANS, has an error, all the indoor units of the same refrigerant system stop fan operation and outdoor units operate intermittently for 3 minutes.

⑤ To delete error code

When something is wrong with air conditioner, error code (P1 etc.) is memorized, but error code can be deleted after termination of service.

<To delete error cord with remote controller>

(1) Display the error cord at the self-diagnosis result display screen.

b) Alternating display

(2) The address for self-diagnosis will blink when the Ⓛ button is pressed twice within three seconds.

(3) The display (3) shown on the left will be appeared when the error cord has been reset. Note that the error content will be redisplayed if error cord resetting is unsuccessful.

<To delete error cord with switch of outdoor unit>

Refer to 10-8. Function of switches, connectors and jumpers on page 49.

(2) Digital wireless remote controller
<In case of trouble during operation>

When a malfunction occurs to air conditioner, both indoor unit and outdoor unit will stop and operation lamp blinks to inform unusual stop.

<Malfunction-diagnosis method at maintenance service>

[Procedure]

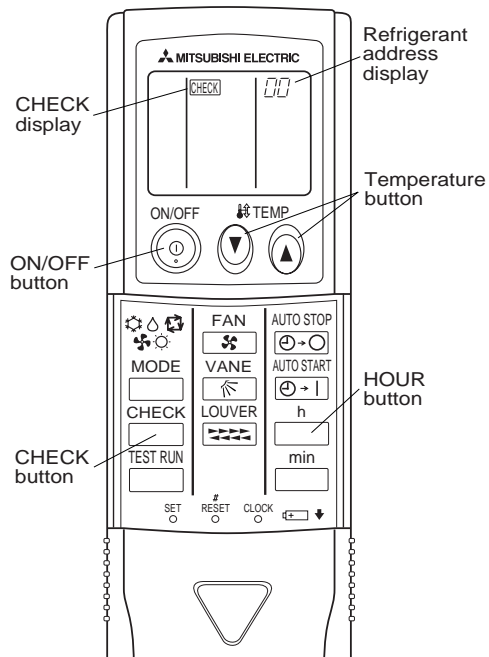

1. Press the CHECK button twice.
 - "CHECK" lights, and refrigerant address "00" flashes.
 - Check that the remote controller's display has stopped before continuing.
2. Press the temperature \uparrow \downarrow buttons.
 - Select the refrigerant address of the indoor unit for the self-diagnosis.
 - Note: Set refrigerant address using the outdoor unit's DIP switch (SW1). (For more information, see the outdoor unit installation manual.)
3. Point the remote controller at the sensor on the indoor unit and press the HOUR button.
 - If an air conditioner error occurs, the indoor unit's sensor emits an intermittent buzzer sound, the operation light flashes, and the error code is output. (It takes 3 seconds at most for error code to appear.)
4. Point the remote controller at the sensor on the indoor unit and press the ON/OFF button.
 - The check mode is canceled.

* Malfunction diagnosis can be performed only for refrigerant system controlling wireless units.

Inspected unit	Error code	Beep output	Operation LED	Inspected unit	Check code	Beep output	Operation LED
Indoor unit	P1	beep × 1 time	1 sec. × 1 time	Outdoor unit	F1–F9	beep beep × 1 time	(0.4sec+0.4sec) × 1 time
	P2	beep × 2 times	1 sec. × 2 times		U0–UP		
	P4	beep × 4 times	1 sec. × 4 times		E6–EE		
	P5	beep × 5 times	1 sec. × 5 times	—	No check code (normal)	No output	Lights off
	P6	beep × 6 times	1 sec. × 6 times	—	No check code (mistake of matching with refrigerant address)	beep beep beep	Lights off
	P8	beep × 8 times	1 sec. × 8 times				
	P9	beep × 2 times	1 sec. × 2 times				
E4, E5	Other than above	Other than above					

10-3-2. Wired Remote controller Diagnosis

If operation can not be carried out from remote controller, try remote controller diagnosis with following process.

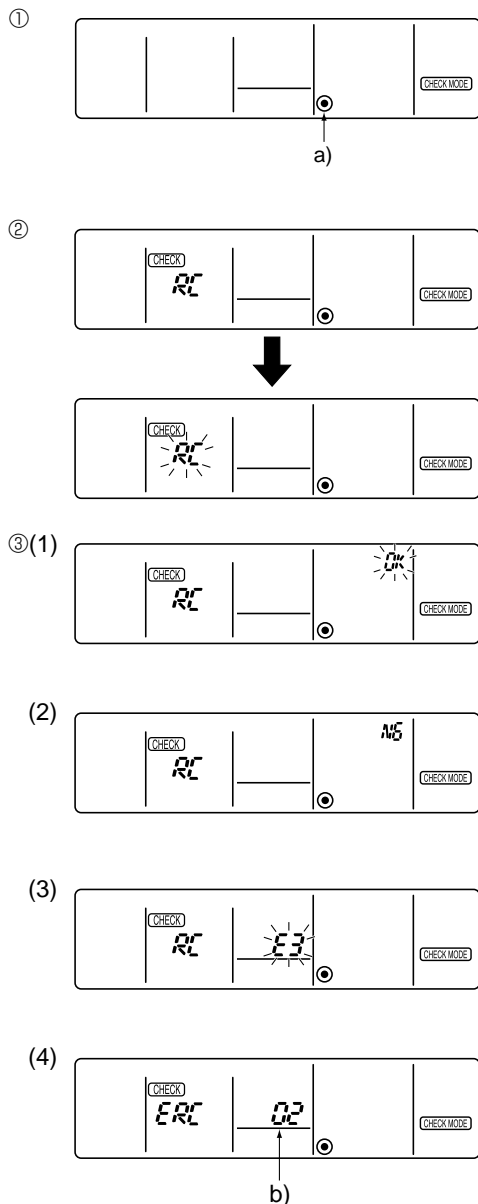

- ① First, check the electricity current marker.
When correct voltage (DC12V) is not supplied to remote controller, the electricity current marker is put out.
If the electricity current marker is not lighted, check the remote controller wiring and the indoor units.
a) Electric current marker
- ② Transfer to remote controller diagnosis mode
Hold down the ⊕ “CHECK” button for five seconds or more, and following display appears.
Press the Ⓐ “FILTER” button, and remote controller diagnosis will begin.
- ③ Remote controller diagnosis result
 - (1) When the remote controller is functioning correctly
Check other possible causes, as there is no problem with remote controller.
Consider the unit is normal when remote controller transmits the result of diagnosis to indoor or outdoor unit and receives the same data back.
 - (2) When remote controller has malfunction
The remote controller must be replaced.
If the transmitting-receiving circuit is defective, [‘NG’] blinks.
“NG” will be displayed when remote controller transmits the result of diagnosis to indoor or outdoor unit, and receives no response.

When there might be other problems than diagnosed remote controller,

- (3) There might be noise on transmission path or damage of other remote controllers or indoor units. Check the transmission path and other controllers.
If the transmission is not possible, [E3] blinks.
“E3” will be displayed when remote controller transmits the result of diagnosis to indoor or outdoor unit and receives different data back.
- (4) The number of data errors means the difference between the number of bits sent from remote controller and the actual number of bits sent to transmission path.
If the data error is displayed, noise and etc. are interfering with the transmission data. Check the transmission path.
If the data error has occurred, [ERC] and number of data errors are displayed.
b) Number of generated data errors (maximum 66 errors)

When the number of data errors is 02.

Transmission data from remote controller

Transmission data on transmission path

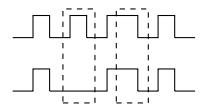

- ④ Cancel the remote controller diagnosis
Hold down the ⊕ “CHECK” button for five seconds or more to cancel remote controller diagnosis, then [H0] operation lamp will blink and the display screen will return to the status before remote controller diagnosis in about 30 seconds.

10-4. SELF-DIAGNOSIS ACTION TABLE

<Abnormalities detected when the power is put on>

(Note 1) Refer to indoor unit section for code P and code E.

Error Code	Meaning of error code and detection method	Case	Judgment and action
None	—	<ul style="list-style-type: none"> ① No voltage is supplied to terminal block TB1 of outdoor unit. <ul style="list-style-type: none"> a) Power supply breaker is put off. b) Contact failure or disconnection of power supply terminal c) Open phase (L or N phase) ② Electric power is not charged to power supply terminal of outdoor power board. <ul style="list-style-type: none"> a) Contact failure of power supply terminal b) Open phase on the outdoor power board <ul style="list-style-type: none"> RP3V :Disconnection of connector R or S RP4V~6V :Disconnection of connector SC-R or SC-S ③ Electric power is not supplied to outdoor controller board. <ul style="list-style-type: none"> a) Disconnection of connector (CNDC) ④ Disconnection of reactor (DCL or ACL) ⑤ Disconnection of noise filter(NF) or parts failure in noise filter ⑥ Defective outdoor power board ⑦ Defective outdoor controller board 	<ul style="list-style-type: none"> ① Check following items. <ul style="list-style-type: none"> a) Power supply breaker b) Connection of power supply terminal block c) Connection of power supply terminal block ② Check following items. <ul style="list-style-type: none"> a) Connection of power supply terminal block b) Connection of terminal on outdoor power board ③ Check connection between outdoor controller board and outdoor power board ④ Check connection of reactor ⑤ a) Check connection of noise filter b) Replace noise filter ⑥ Replace outdoor power board ⑦ Replace controller board (When items above are checked but the units can not be repaired.)
F3 (5202)	<p>63L connector open Abnormal if 63L connector circuit is open for three minutes continuously after power supply. 63L: Low-pressure switch <PUHZ-RP4~6VHA only></p>	<ul style="list-style-type: none"> ① Disconnection or contact failure of 63L connector on outdoor controller board ② Disconnection or contact failure of 63L ③ 63L is working due to refrigerant leakage or defective parts. ④ Defective outdoor controller board 	<ul style="list-style-type: none"> ① Check connecting wire. ② Check connecting wire. ③ Check refrigerant pressure. Charge additional refrigerant. Check continuity by tester. Replace the parts if the parts are defective. ④ Replace outdoor controller board.
F5 (5201)	<p>63H connector open Abnormal if 63H connector circuit is open for three minutes continuously after power supply. 63H: High-pressure switch</p>	<ul style="list-style-type: none"> ① Disconnection or contact failure of 63H connector on outdoor controller board ② Disconnection or contact failure of 63H ③ 63H is working due to defective parts. ④ Defective outdoor controller board 	<ul style="list-style-type: none"> ① Check connecting wire. ② Check connecting wire. ③ Check continuity by tester. Replace the parts if the parts are defective. ④ Replace outdoor controller board.
F9 (4119)	<p>2 connector open Abnormal if both 63H and 63L connector circuits are open for three minutes continuously after power supply. 63H: High-pressure switch 63L: Low-pressure switch <PUHZ-RP4~6VHA only></p>	<ul style="list-style-type: none"> ① Disconnection or contact failure of connector (63H,63L) on outdoor controller board ② Disconnection or contact failure of 63H, 63L ③ 63H and 63L are working due to defective parts ④ Defective outdoor controller board 	<ul style="list-style-type: none"> ① Check connecting wire. ② Check connecting wire. ③ Check continuity by tester. Replace the parts if the parts are defective. ④ Replace outdoor controller board.



Error Code	Meaning of error code and detection method	Case	Judgment and action
EA (6844)	<p>Indoor/outdoor unit connector mis-wiring, excessive number of units (4 units or more)</p> <p>1. Outdoor controller board can automatically check the number of connected indoor units. Abnormal if the number cannot be checked automatically due to mis-wiring of indoor/outdoor unit connecting wire and etc. after power is turned on for 4 minutes.</p> <p>2. Abnormal if outdoor controller board recognizes the number of connected indoor units as "4 units or more".</p>	<p>① Contact failure or mis-wiring of indoor/outdoor unit connecting wire</p> <p>② Diameter or length of indoor/outdoor unit connecting wire is out of specified capacity.</p> <p>③ 4 or more indoor units are connected to one outdoor unit.</p> <p>④ Defective transmitting receiving circuit of outdoor controller board</p> <p>⑤ Defective transmitting receiving circuit of indoor controller board</p> <p>⑥ Defective indoor power board</p> <p>⑦ Two or more outdoor units have refrigerant address "0" . (In case of group control)</p> <p>⑧ Noise has entered into power supply or indoor / outdoor unit connecting wire.</p>	<p>① Check disconnection or looseness or polarity of indoor/outdoor unit connecting wire of indoor and outdoor units.</p> <p>② Check diameter and length of indoor/outdoor unit connecting wire. Outdoor-indoor units' interval: 50m maximum Indoor-indoor units' interval: 30m maximum Also check if the connection order of flat cable (VVF etc.) is S1, S2, S3.</p> <p>③ Check the number of indoor units that are connected to one outdoor unit. (If EA is detected)</p> <p>④~⑥ Put the power off once, and on again to check. Replace outdoor controller board, indoor controller board or indoor power board if abnormality occurs again.</p> <p>⑦ Check if refrigerant addresses (SW1-3 to SW1-6 on outdoor controller board) are overlapping in case of group control system.</p> <p>⑧ Check transmission path, and remove the cause.</p>
Eb (6845)	<p>Mis-wiring of indoor/outdoor unit connecting wire (converse wiring or disconnection)</p> <p>Outdoor controller board can automatically set the unit number of indoor units. Abnormal if the indoor unit number can not be set within four minutes after power on because of mis-wiring (converse wiring or disconnection) of indoor/outdoor unit connecting wire.</p>	<p>① Contact failure or mis-wiring of indoor/outdoor unit connecting wire</p> <p>② Diameter or length of indoor/outdoor unit connecting wire is out of specified capacity.</p> <p>④ Defective transmitting receiving circuit of outdoor controller board</p> <p>⑤ Defective transmitting receiving circuit of indoor controller board</p> <p>⑥ Defective indoor power board</p> <p>⑦ Two or more outdoor units have refrigerant address "0" . (In case of group control)</p> <p>⑧ Noise has entered into power supply or indoor/outdoor unit connecting wire.</p>	
EC (6846)	<p>Start-up time over</p> <p>The unit can not finish start-up process within four minutes after power on.</p>	<p>① Contact failure of indoor/outdoor unit connecting wire</p> <p>② Diameter or length of indoor/outdoor unit connecting wire is out of specified capacity.</p> <p>⑦ Two or more outdoor units have refrigerant address "0" . (In case of group control)</p> <p>⑧ Noise has entered into power supply or indoor/outdoor unit connecting wire.</p>	

<Abnormalities detected while unit is operating>

Error Code	Meaning of error code and detection method	Case	Judgment and action
U1 (1302)	Abnormal high pressure (High-pressure switch 63H worked) Abnormal if high-pressure switch 63H worked (more than 4.41 MPa) during compressor operation. 63H: High-pressure switch	① Short cycle of indoor unit ② Clogged filter of indoor unit ③ Decreased airflow caused by dirt of indoor fan ④ Dirt of indoor heat exchanger ⑤ Locked indoor fan motor ⑥ Malfunction of indoor fan motor ⑦ Defective operation of stop valve (Not full open) ⑧ Clogged or broken pipe ⑨ Locked outdoor fan motor ⑩ Malfunction of outdoor fan motor ⑪ Short cycle of outdoor unit ⑫ Dirt of outdoor heat exchanger ⑬ Decreased airflow caused by defective inspection of outside temperature thermistor (It detects lower temperature than actual temperature.) ⑭ Disconnection or contact failure of connector (63H) on outdoor controller board ⑮ Disconnection or contact failure of 63H connection ⑯ Defective outdoor controller board ⑰ Defective action of linear expansion valve ⑱ Malfunction of fan driving circuit	①~⑥ Check indoor unit and repair defectives. ⑦ Check if stop valve is full open. ⑧ Check piping and repair defectives. ⑨~⑫ Check outdoor unit and repair defectives. ⑬ Check the inspected temperature of outside temperature thermistor on LED display. (A-Control Service Tool : Refer to P53-60.) ⑭~⑯ Put the power off and check F5 is displayed when the power is put again. When F5 is displayed, refer to "Judgment and action" for F5. ⑰ Check linear expansion valve. Refer to P39. ⑱ Replace outdoor controller board.
U2 (1102)	Abnormal high discharging temperature Abnormal if discharge temperature thermistor (TH4) exceeds 110°C continuously for 5 minutes. Abnormal if condenser/evaporator temperature thermistor (TH5) exceeds 40°C during defrosting and discharge temperature thermistor (TH4) exceeds 110°C.	① Over-heated compressor operation caused by shortage of refrigerant ② Defective operation of stop valve ③ Defective thermistor ④ Defective outdoor controller board ⑤ Defective action of linear expansion valve	① Check intake super heat. Check leakage of refrigerant. Charge additional refrigerant. ② Check if stop valve is full open. ③④ Put the power off and check if U3 is displayed when the power is put again. When U3 is displayed, refer to "Judgement and action" for U3. ⑤ Check linear expansion valve. Refer to P39.
U3 (5104)	Open/short circuit of discharge temperature thermistor (TH4) Abnormal if open (3°C or less) or short (217°C or more) is detected during compressor operation. (Detection is inoperative for 10 minutes of compressor starting process and for 10 minutes after and during defrosting.)	① Disconnection or contact failure of connector (TH4) ② Defective thermistor ③ Defective outdoor controller board	① Check contact of connector or electric wire of thermistor. ② Check resistance value of thermistor, or check temperature by microcomputer (A-Control Service Tool : Refer to P53-60.) Refer to P39. ③ Replace outdoor controller board.
U4 (TH3:5105) (TH6:5107) (TH7:5106) (TH8:5110)	Open/short of outdoor unit thermistors (TH3, TH6, TH7, and TH8) Abnormal if open or short is detected during compressor operation. Open detection of thermistors TH3 and TH6 is inoperative for 10 seconds to 10 minutes after compressor starting and 10 minutes after and during defrosting. *Check which unit has abnormality in its thermistor by switching the mode of SW2. (Refer to page 58.)	① Disconnection or contact failure of connectors (TH3/TH6/TH7/TH8) ② Defective thermistor ③ Defective outdoor controller board	① Check contact of connector or electric wire of thermistor. ② Check resistance value of thermistor, or check temperature by microcomputer (Mode (A-Control Service Tool : Refer to P53-60.) Refer to P39. ③ Replace outdoor controller board. *Emergency operation is available in case of abnormalities of TH3, TH6 and TH7. Refer to P43.

Thermistors		Open detection	Short detection
Symbol	Name		
TH3	Pipe temperature thermistor / Liquid	- 40°C or below	90°C or above
TH6	Condenser/evaporator temperature thermistor	- 40°C or below	90°C or above
TH7	Outside temperature thermistor	- 40°C or below	90°C or above
TH8	Heat sink temperature thermistor	- 27°C or below	102°C or above

Error Code	Meaning of error code and detection method	Case	Judgment and action
U5 (4230)	Abnormal temperature of heat sink Abnormal if heat sink thermistor(TH8) detects temperature indicated below. RP3VHA.....77°C RP4~RP6VHA.....85°C	<ol style="list-style-type: none"> ① Outdoor fan is blocked. ② Failure of outdoor fan motor ③ Air flow path is clogged. ④ Rise of ambient temperature ⑤ Defective thermistor ⑥ Defective input circuit of outdoor power board ⑦ Failure of outdoor fan drive circuit 	<ol style="list-style-type: none"> ①② Check outdoor fan. Refer to P39. ③ Check air flow path for cooling. ④ Check if there is something which causes temperature rise around outdoor unit. (Upper limit of ambient temperature is 46°C.) Turn off power, and on again to check if U5 is displayed within 30 minutes. If U4 is displayed instead of U5, follow the action to be taken for U4. ⑤ Check the resistance value of thermistor or temperature by microcomputer. (A-Control Service Tool : Refer to P53-60.) Refer to P39. ⑥ Replace outdoor power board. ⑦ Replace outdoor controller board.
U6 (4250)	Abnormality of power module Check abnormality by driving power module in case overcurrent is detected. (UF or UP error condition)	<ol style="list-style-type: none"> ① Outdoor stop valve is closed. ② Decrease of power supply voltage ③ Looseness, disconnection or converse of compressor wiring connection ④ Defective compressor ⑤ Defective outdoor power board 	<ol style="list-style-type: none"> ① Open stop valve. ② Check facility of power supply. ③ Correct the wiring (U•V•W phase) to compressor. ④ Check compressor referring to P39. ⑤ Replace outdoor power board.
U7 (1520)	Abnormality of super heat due to low discharge temperature (RP3VHA) Abnormal if discharge super heat is continuously detected less than or equal to 0°C for 3 minutes even though linear expansion valve has minimum open pulse after compressor starts operating for 10 minutes. (RP3VHA only)	<ol style="list-style-type: none"> ① Disconnection or loose connection of discharge temperature thermistor (TH4) ② Defective holder of discharge temperature thermistor ③ Disconnection or loose connection of linear expansion valve's coil ④ Disconnection or loose connection of linear expansion valve's connector ⑤ Defective linear expansion valve 	<ol style="list-style-type: none"> ①② Check the installation conditions of discharge temperature thermistor. ③ Check the coil of linear expansion valve. Refer to P42. ④ Check the connection or contact of LEV-A and LEV-B on outdoor controller board. ⑤ Check linear expansion valve. Refer to P39.
U9 (4220)	Abnormality such as overvoltage or voltage shortage and abnormal synchronous signal to main circuit Abnormal if any of followings are detected during compressor operation; <ul style="list-style-type: none"> • Decrease of DC bus voltage to 310V • Instantaneous decrease of DC bus voltage to 200V • Increase of DC bus voltage to RP3VHA : 420V RP4-6VHA : 400V • Decrease of input current of outdoor unit to 0.5A only if operation frequency is more than or equal to 40Hz or compressor current is more than or equal to 5A. 	<ol style="list-style-type: none"> ① Decrease of power supply voltage ② Disconnection of compressor wiring ③ Defective 52C ④ Disconnection or loose connection of CN52C ⑤ Defective PFC module of outdoor power board (RP3VHA only) ⑥ Defective ACT module (RP4-6VHA only) ⑦ Defective ACT module drive circuit of outdoor power board (RP4-6VHA only) ⑧ Disconnection or loose connection of CNAF (RP4-6VHA only) ⑨ Defective 52C drive circuit of outdoor control board ⑩ Disconnection or loose connection of CN5 ⑪ Disconnection or loose connection of CN2 	<ol style="list-style-type: none"> ① Check the facility of power supply. ② Correct the wiring (U•V•W phase) to compressor. ③ Replace 52C. ④ Check CN52C wiring. ⑤ Replace outdoor power board. (RP3VHA only) ⑥ Replace ACT module. (RP4-6VHA only) ⑦ Replace outdoor power board. (RP4-6VHA only) ⑧ Check CNAF wiring. (RP4-6VHA only) ⑨ Replace outdoor controller board. ⑩ Check CN5 wiring. ⑪ Check CN2 wiring.



Error Code	Meaning of error code and detection method	Case	Judgment and action
UF (4100)	Compressor overcurrent interruption (When compressor locked) Abnormal if overcurrent of DC bus or compressor is detected within 30 seconds after compressor starts operating.	① Stop valve is closed. ② Decrease of power supply voltage ③ Looseness, disconnection or converse of compressor wiring connection ④ Defective compressor ⑤ Defective outdoor power board	① Open stop valve. ② Check facility of power supply. ③ Correct the wiring (U•V•W phase) to compressor. ④ Check compressor. Refer to P39. ⑤ Replace outdoor power board.
UH (5300)	Current sensor error Abnormal if current sensor detects -1.5A to 1.5A during compressor operation. (This error is ignored in case of test run mode.)	① Disconnection of compressor wiring ② Defective circuit of current sensor on outdoor power board	① Correct the wiring (U•V•W phase) to compressor. ② Replace outdoor power board.
UL (1300)	Abnormal low pressure (63L worked) Abnormal if 63L is worked (under-0.03MPa) during compressor operation. 63L: Low-pressure switch (RP4~RP6VHA only)	① Stop valve of outdoor unit is closed during operation. ② Disconnection or loose connection of connector (63L) on outdoor controller board ③ Disconnection or loose connection of 63L ④ Defective outdoor controller board ⑤ Leakage or shortage of refrigerant ⑥ Malfunction of linear expansion valve	① Check stop valve. ②~④ Put the power off and on again to check if F3 is displayed on restarting. If F3 is displayed, follow the F3 processing direction. ⑤ Correct to proper amount of refrigerant. Refer to P10. ⑥ Check linear expansion valve. Refer to P41.
UP (4210)	Compressor overcurrent interruption Abnormal if overcurrent DC dc bus or compressor is detected after compressor starts operating for 30 seconds.	① Stop valve of outdoor unit is closed. ② Decrease of power supply voltage ③ Looseness, disconnection or converse of compressor wiring connection ④ Defective fan of indoor/outdoor units ⑤ Short cycle of indoor/outdoor units ⑥ Defective input circuit of outdoor controller board ⑦ Defective compressor	① Open stop valve. ② Check facility of power supply. ③ Correct the wiring (U•V•W phase) to compressor. ④ Check indoor/outdoor fan. ⑤ Solve short cycle. ⑥ Replace outdoor controller board. ⑦ Check compressor. Refer to P39.
E0 (No display)	Remote controller communication error (Signal receiving error) (1) Abnormal if any signal from IC of refrigerant address "0" could not be normally received for three minutes. (2) Abnormal if sub remote controller could not receive any signal for two minutes.	① Defective communication circuit of remote controller ② Defective communication circuit of indoor controller board of refrigerant address "0" ③ Noise has entered into transmission line of remote controller. ④ All remote controllers are set as "sub" remote controller. In this case, E4 is displayed at outdoor LED, and E0 is displayed at remote controller.	①~③ Diagnose remote controller. Take actions as follows according to diagnosis result. a) When "RC OK" is displayed, remote controllers have no problem. Put the power off, and on again to check. If, "H0" is displayed for four minutes or more, replace indoor controller board. b) When "NG" is displayed, replace remote controller. c) When "RC E3" or "ERC 00-66" is displayed, noise may be causing abnormality.
E3 (No display)	Remote controller communication error (Transmitting error) (1) Abnormal if sub remote controller could not find blank of transmission path for six seconds. (2) Abnormal if remote controller could not finish transmitting 30 times continuously.	① Defective communication circuit of remote controller ② Noise has entered into transmission line of remote controller. ③ Two remote controllers are set as "main." (In case of 2 remote controllers)	④ Set a remote controller to main, and the other to sub.
E8 (6840)	Indoor/outdoor unit communication error (Signal receiving error) (Outdoor unit) (1) Abnormal if outdoor controller board could not receive anything normally for three minutes.	① Contact failure of indoor/outdoor unit connecting wire ② Defective communication circuit of outdoor controller board ③ Defective communication circuit of indoor controller board ④ Noise has entered into indoor/outdoor unit connecting wire.	① Check disconnection or looseness of indoor/outdoor unit connecting wire of indoor or outdoor units. ②~④ Put the power off, and on again to check. Replace indoor controller board or outdoor controller board if abnormality is displayed again.

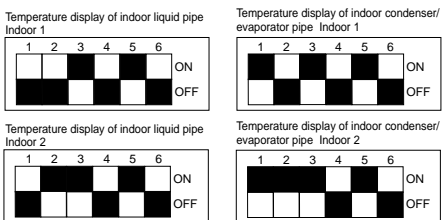

Error Code	Meaning of error code and detection method	Case	Judgment and action
E9 (6841)	Indoor/outdoor unit communication error (Transmitting error) (Outdoor unit) (1) Abnormal if "0" receiving is detected 30 times continuously though outdoor controller board has transmitted "1". (2) Abnormal if outdoor controller board could not find blank of transmission path for three minutes.	① Indoor/ outdoor unit connecting wire has contact failure. ② Defective communication circuit of outdoor controller board ③ Noise has entered power supply. ④ Noise has entered indoor/ outdoor unit connecting wire.	① Check disconnection or looseness of indoor/outdoor unit connecting wire. ②~④ Put the power off, and on again to check. Replace outdoor controller board if abnormality is displayed again.
EF (6607 or 6608)	Non defined error code This code is displayed when non defined error code is received.	① Noise has entered transmission wire of remote controller. ② Noise has entered indoor/ outdoor unit connecting wire. ③ Outdoor unit is not a series of power-inverter. ④ Model name of remote controller is PAR-S25A.	①② Put the power off, and on again to check. Replace indoor controller board or outdoor controller board if abnormality is displayed again. ③ Replace outdoor unit with power-inverter type outdoor unit. ④ Replace remote controller with MA remote controller.
Ed (0403)	Serial communication error 1. Abnormal if serial communication between outdoor controller board and outdoor power board is defective.	① Breaking of wire or contact failure of connector CN2 ② Breaking of wire or contact failure of connector CN4 ③ Defective communication circuit of outdoor power board ④ Defective communication circuit of outdoor controller board for power board	①② Check connection of each connector CN2, CN4. ③ Replace outdoor power board. ④ Replace outdoor controller board.
	2. Abnormal if communication between outdoor controller board and M-NET p.c. board is not available.	① Breaking of wire or contact failure of connector between outdoor controller board and M-NET p.c. board ② Contact failure of M-NET p.c. board power supply line ③ Noise has entered into M-NET transmission wire.	① Check disconnection, looseness, or breaking of connection wire between outdoor controller board(CNMNT) and M-NET p.c. board(CN5). ② Check disconnection, looseness, or breaking of connection wire between outdoor controller board(CNMNT) and M-NET p.c. board(CND).

Error Code	Meaning of error code and detection method	Case	Judgment and action
P8	Abnormality of pipe temperature <Cooling mode> Detected as abnormal when the pipe temperature is not in the cooling range 3 minutes later of compressor start and 6 minutes later of the liquid or condenser/evaporator pipe is out of cooling range. Note 1) It takes at least 9 min. to detect. Note 2) Abnormality P8 is not detected in drying mode. Cooling range : Indoor pipe temperature (TH2 or TH5) – intake temperature (TH1) ≤ -3 deg TH: Lower temperature between: liquid pipe temperature and condenser/ evaporator temperature <Heating mode> When 10 seconds have passed after the compressor starts operation and the hot adjustment mode has finished, the unit is detected as abnormal when condenser/evaporator pipe temperature is not in heating range within 20 minutes. Note 3) It takes at least 27 minutes to detect abnormality. Note 4) It excludes the period of defrosting (Detection restarts when defrosting mode is over) Heating range : 3 deg ≤ (Condenser/ Evaporator temperature(TH5) – intake temperature(TH1))	① Slight temperature difference between indoor room temperature and pipe <liquid or condenser-evaporator> temperature thermistor • Shortage of refrigerant • Disconnected holder of pipe <liquid or condenser-evaporator> thermistor • Defective refrigerant circuit ② Converse connection of extension pipe (on plural units connection) ③ Converse wiring of indoor/outdoor unit connecting wire (on plural units connection) ④ Defective detection of indoor room temperature and pipe <condenser-evaporator> temperature thermistor ⑤ Stop valve is not opened completely.	①~④ Check pipe <liquid or condenser-evaporator> temperature with room temperature display on remote controller and outdoor controller board. Pipe <liquid or condenser-evaporator> temperature display is indicated by setting SW2 of outdoor controller board as follows. (Conduct temperature check with outdoor controller board after connecting 'A-Control Service Tool(PAC-SK52ST)')  <p style="text-align: center;">A-Control Service Tool SW2 setting</p> ②③ Check converse connection of extension pipe or converse wiring of indoor/outdoor unit connecting wire.

<M-NET communication error>

(Note) "Indoor unit" in the text indicates M-NET p.c. board in outdoor unit.

Error Code	Meaning of error code and detection method	Case	Judgment and action
A0 (6600)	<p>Address duplicate definition This error is displayed when transmission from the units of same address is detected. Note) The address and attribute displayed at remote controller indicate the controller that detected abnormality.</p>	<p>① There are two or more same address of controller of outdoor unit, indoor unit, FRESH MASTER, or LOSSNAY. ② Noise has entered into transmission signal and signal was transformed.</p>	<p>Search the unit with same address as abnormality occurred. If the same address is found, shut of the power supply of outdoor unit and indoor unit and FRESH MASTER or LOSSNAY at the same time for two minutes or more after the address is corrected, and put the power on again. Check transmission waveform or noise on transmission wire.</p>
A2 (6602)	<p>Hard ware error of transmission processor Transmission processor intended to transmit "0", but "1" appeared on transmission wire. Note) The address and attribute display at remote controller indicate the controller that detected abnormality.</p>	<p>① Error is detected if waveform is transformed when wiring works of transmission wire of outdoor unit, indoor unit, FRESH MASTER or LOSSNAY are done, or polarity is changed with the power on and transmission data collide each other. ② Defective transmitting receiving circuit of transmission processor ③ Transmission data is changed by the noise on transmission.</p>	<p>① If the works of transmission wire is done with the power on, shut off the power supply of outdoor unit and indoor unit and FRESH MASTER or LOSSNAY at the same time for two minutes or more, and put the power on again. ② Check transmission waveform or noise on transmission wire.</p>
A3 (6603)	<p>BUS BUSY 1. Over error by collision damage Abnormal if transmitting is not possible for 8-10 minutes continuously because of collision of transmission. 2. Data could not reach transmission wire for 8-10 minutes continuously because of noise or etc. Note) The address and attribute displayed at remote controller indicate the controller that detected abnormality.</p>	<p>① Transmission processor could not transmit because short cycle voltage of noise and the like have entered into transmission wire continuously. ② Transmission quantity has increased and transmission is not possible because there was wiring mistake of terminal block for transmission wire (TB3) and terminal block for central control (TB7) in outdoor unit. ③ Transmission are mixed with others and occupation rate on transmission wire rose because of defective repeater (a function to connector or disconnect transmission of control and central control system) of outdoor unit, then abnormality is detected.</p>	<p>① Check if transmission wire of indoor unit, FRESH MASTER, LOSSNAY, or remote controller is not connected to terminal block for central control (TB7) of outdoor unit. ② Check if transmission wire of indoor unit, FRESH MASTER or LOSSNAY is not connected to terminal block for transmission wire of outdoor unit. ③ Check if terminal block for transmission wire (TB3) and terminal block for central control (TB7) is not connected. ④ Check transmission waveform or noise on transmission wire.</p>
A6 (6606)	<p>Communication error with communication processor Defective communication between unit processor and transmission processor Note) The address and attribute display at remote controller indicate the controller that detected abnormality.</p>	<p>① Data of transmission processor or unit processor is not transmitted normally because of accidental trouble such as noise or thunder surge. ② Address forwarding from unit processor is not transmitted normally because of defective transmission processor hardware.</p>	<p>Shut of the power supply of outdoor unit and indoor unit and FRESH MASTER or LOSSNAY at the same time for two minutes or more, and put the power on again. System returns normally if abnormality was accidental malfunction. If the same abnormality generates again, abnormality-generated controller may be defective.</p>

Error Code	Meaning of error code and detection method	Case	Judgment and action
A7 (6607)	<p>NO ACK signal</p> <p>1. Transmitting side controller detects abnormal if a message was transmitted but there is no reply (ACK) that a message was received. Transmitting side detects abnormality every 30 seconds, six times continuously.</p> <p>Note) The address and attribute displayed at remote controller indicate the controller that did not reply (ACK).</p>	<p>Common factor that has no relation with abnormality source.</p> <p>① The unit of former address does not exist as address switch has changed while the unit was energized.</p> <p>② Extinction of transmission wire voltage and signal is caused by over-range transmission wire.</p> <ul style="list-style-type: none"> • Maximum distance200m • Remote controller line ..(12m) <p>③ Extinction of transmission wire voltage and signal is caused by type-unmatched transmission wire.</p> <p>Type</p> <p style="padding-left: 20px;">With shield wire- CVVS, CPEVS</p> <p style="padding-left: 20px;">With normal wire (no shield)- VCTF, VCTFK, CVV CVS, VVR, VVF, VCT</p> <p style="padding-left: 20px;">Diameter....125mm² or more</p> <p>④ Extinction of transmission wire voltage and signal is caused by over-numbered units.</p> <p>⑤ Accidental malfunction of abnormality-detected controller (noise, thunder surge)</p> <p>⑥ Defective of abnormality-generated controller</p>	<p>① Shut off the power supply of outdoor unit and indoor unit and FRESH MASTER or LOSSNAY at the same time for two minutes or more, and put the power on again. If malfunction was accidental, the unit returns to normal.</p> <p>② Check address switch of abnormality-generated address.</p> <p>③ Check disconnection or looseness of abnormality-generated or abnormality-detected transmission wire (terminal block and connector)</p> <p>④ Check if tolerance range of transmission wire is not exceeded.</p> <p>⑤ Check if type of transmission wire is correct or not.</p> <p>If there were some trouble of ①-⑤ above, repair the defective, then shut off the power supply of outdoor unit and indoor unit and FRESH MASTER or LOSSNAY at the same time for two minutes or more, and put the power on again.</p> <ul style="list-style-type: none"> • If there was no trouble with ①-⑤ above in single refrigerant system (one outdoor unit), controller of displayed address or attribute is defective. • If there was no trouble with ①-⑤ above in different refrigerant system (two or more outdoor units), judge with ⑥.
	<p>2. If displayed address or attribute is outdoor unit, Indoor unit detects abnormality when indoor unit transmitted to outdoor unit and there was no reply (ACK).</p>	<p>① Contact failure of transmission wire of outdoor unit or indoor unit</p> <p>② Disconnection of transmission connector (CN2M) of outdoor unit</p> <p>③ Defective transmitting receiving circuit of outdoor unit or indoor unit</p>	<p>⑥ If address of abnormality source is the address that should not exist, there is the unit that memorizes nonexistent address information. Delete useless address information with manual setting function of remote controller.</p> <p>Only the system FRESH MASTER or LOSSNAY are connected to, or the system that is equipped with group setting of different refrigerant system.</p>
	<p>3. If displayed address or attribute is indoor unit, Remote controller detects abnormality when remote controller transmitted to indoor unit and there was no reply (ACK).</p>	<p>① During group operation with indoor unit of multi- refrigerant system, if remote controller transmit to indoor unit while outdoor unit power supply of one refrigerant system is put off or within two minutes of restart, abnormality is detected.</p> <p>② Contact failure of transmission wire of remote controller or indoor unit</p> <p>③ Disconnection of transmission connector (CN2M) of indoor unit</p> <p>④ Defective transmitting receiving circuit of indoor unit or remote controller</p>	<p>If there was no trouble with ①-⑥ above, replace the controller board of displayed address or attribute.</p> <p>If the unit does not return normally, multi-controller board of outdoor unit may be defective (repeater circuit).</p> <p>Replace multi-controller board one by one to check if the unit returns normally.</p>
	<p>4. If displayed address or attribute is remote controller, Indoor unit detects abnormality when indoor unit transmitted to remote controller and there was no reply (ACK).</p>	<p>① During group operation with indoor unit of multi- refrigerant system, if indoor unit transmit to remote controller while outdoor unit power supply of one refrigerant system is put off or within two minutes of restart, abnormality is detected.</p> <p>② Contact failure of transmission wire of remote controller or indoor unit</p> <p>③ Disconnection of transmission connector (CN2M) of indoor unit</p> <p>④ Defective transmitting receiving circuit of indoor unit or remote controller</p>	



Error Code	Meaning of error code and detection method	Case	Judgment and action
<p style="text-align: center;">A7 (6607)</p>	<p>5. If displayed address or attribute is FRESH MASTER, Indoor unit detects abnormality when indoor unit transmitted to FRESH MASTER and there was no reply (ACK).</p>	<p>① During sequential operation of indoor unit and FRESH MASTER of other refrigerant system, if indoor unit transmits to FRESH MASTER while outdoor unit power supply of same refrigerant system with FRESH MASTER is put off or within two minutes of restart, abnormality is detected. ② Contact failure of transmission wire of indoor unit or FRESH MASTER ③ Disconnection of transmission connector (CN2M) of indoor unit or FRESH MASTER ④ Defective transmitting receiving circuit of indoor unit or FRESH MASTER</p>	
	<p>6. If displayed address or attribute is LOSSNAY, Indoor unit detects abnormality when indoor unit transmitted to LOSSNAY and there was no reply (ACK).</p>	<p>① If the power supply of LOSSNAY is off, indoor unit detects abnormality when it transmits to LOSSNAY. ② During sequential operation of indoor unit and LOSSNAY of other refrigerant system, if indoor unit transmits to LOSSNAY while outdoor unit power supply of same refrigerant system with LOSSNAY is put off or within two minutes of restart, abnormality is detected. ③ Contact failure of transmission wire of indoor unit of LOSSNAY ④ Disconnection of transmission connector (CN2M) of indoor unit ⑤ Defective transmitting receiving circuit of indoor unit or LOSSNAY</p>	
	<p>7. If displayed address or attribute is nonexistent,</p>	<p>① The unit of former address does not exist as address switch has changed while the unit was energized. ② Abnormality is detected when indoor unit transmitted because the address of FRESH MASTER and LOSSNAY are changed after sequential operation of FRESH MASTER and LOSSNAY by remote controller.</p>	
<p style="text-align: center;">A8 (6608)</p>	<p>M-NET•NO RESPONSE Abnormal if a message was transmitted and there were reply (ACK) that message was received, but response command does not return. Transmitting side detects abnormality every 30 seconds, six times continuously. Note) The address and attribute displayed at remote controller is indicate the controller that did not reply (ACK).</p>	<p>① Transmitting condition is repeated fault because of noise and the like. ② Extension of transmission wire voltage and signal is caused by over-range transmission wire. • Maximum distance200m • Remote controller line ..(12m) ③ Extension of transmission wire voltage and signal is caused by type-unmatched transmission wire. Type With shield wire- CVVS, CPEVS With normal wire (no shield)- VCTF, VCTFK, CVV CVS, VVR, VVF, VCT Diameter....125mm² or more ④ Accidental malfunction of abnormality-generated controller</p>	<p>① Check transmission waveform or noise on transmission wire. ② Shut off the power supply of outdoor unit and indoor unit and FRESH MASTER or LOSSNAY at the same time for two minutes or more, and put the power on again. If malfunction was accidental, the unit returns to normal. If the same abnormality generates again, controller of displayed address and attribute may be defective.</p>

10-5. TROUBLESHOOTING BY INFERIOR PHENOMENA

Phenomena	Factor	Countermeasure
1. Remote controller display does not work.	<p>①DC12V is not supplied to remote controller. (Power supply display ● is not indicated on LCD.)</p> <p>②DC12~15V is supplied to remote controller, however, no display is indicated.</p> <ul style="list-style-type: none"> • "HO" is not displayed. • "HO" is displayed. 	<p>①Check LED2 on indoor controller board.</p> <p>(1) When LED2 is lit. Check the remote controller wiring for breaking or contact failure.</p> <p>(2) When LED2 is blinking. Check short circuit of remote controller wiring.</p> <p>(3) When LED2 is not lit. Refer to No.3 below.</p> <p>②Check the following.</p> <ul style="list-style-type: none"> • Failure of remote controller if "HO" is not displayed • Refer to No.2 below if "HO" is displayed.
2. "HO" display is remained on the remote controller.	<p>①At longest 2 minutes after the power supply "H0" is displayed to start up.</p> <p>②Communication error between the remote controller and indoor unit</p> <p>③Communication error between the indoor and outdoor unit</p> <p>④Outdoor unit protection device connector is open.</p>	<p>①Normal operation</p> <p>②Self-diagnosis of remote controller</p> <p>③"HO" is displayed for 6 minutes at most. in case of indoor/outdoor unit communication error. Check LED3 on indoor controller board.</p> <p>(1)When LED3 is not blinking. Check indoor/outdoor connecting wire for mis-wiring. (Converse wiring of S1 and S2, or break of S3 wiring.)</p> <p>(2)When LED3 is blinking. Indoor/outdoor connecting wire is normal.</p> <p>④Check LED display on outdoor controller board. Check protection device connector (63L and 63H) for contact failure.</p>
3. When pressing the remote controller operation switch the OPERATION display is appeared but it will be turned off soon.	①After cancelling to select function from the remote controller, the remote controller operation switch will be not accepted for approx 30 seconds.	①Normal operation
4. Even controlling by the wireless remote controller no beep is heard and the unit does not start operating. Operation display is indicated on wireless remote controller.	①The pair number settings of the wireless remote controller and indoor controller board are mismatched.	①Check the pair number settings.
5. When operating by the wireless remote controller, beep sound is heard, however, unit does not start operating.	<p>①No operation for 2 minutes at most after the power supply ON.</p> <p>②Hand-held remote controller operation is prohibited.</p> <ul style="list-style-type: none"> • Remote controlling adaptor is connected to CN32 on the indoor controller board. • Hand-held remote controller operation is prohibited by centralised controller etc. since it is connected to MELANS. <p>③Factor of No.2 above.</p>	<p>①Normal operation</p> <p>②Normal operation</p> <p>③Check the details of No.2 above.</p>
6. Remote controller display works normally and the unit performs cooling operation, however, the capacity cannot be fully obtained. (The air does not cool well.)	<p>①Refrigerant shortage</p> <p>②Filter clogging</p> <p>③Heat exchanger clogging</p> <p>④Air duct short cycle</p>	<p>①• If refrigerant leaks, discharging temperature rises and LEV opening increases. Inspect leakage by checking the temperature and opening.</p> <ul style="list-style-type: none"> • Check pipe connections for gas leakage. <p>②Open suction grill and check the filter. Clean the filter by removing dirt or dust on it.</p> <p>③• If the filter is clogged, indoor pipe temperature rises and discharging pressure increases. Check if heat exchanger is clogged by inspecting discharging pressure.</p> <ul style="list-style-type: none"> • Clean the heat exchanger. <p>④Remove the shield.</p>



Phenomena	Factor	Countermeasure
<p>7. Remote controller display works normally and the unit performs heating operation, however, the capacity cannot be fully obtained.</p>	<p>①Linear expansion valve fault Opening cannot be adjusted well due to linear expansion valve fault.</p> <p>②Refrigerant shortage</p> <p>③Lack of insulation for refrigerant piping</p> <p>④Filter clogging</p> <p>⑤Heat exchanger clogging</p> <p>⑥Air duct short cycle</p> <p>⑦Bypass circuit of outdoor unit fault</p>	<p>①• Discharging temperature and indoor heat exchanger temperature does not rise. Inspect the failure by checking discharging pressure.</p> <ul style="list-style-type: none"> • Replace linear expansion valve. <p>②• If refrigerant leaks, discharging temperature rises and LEV opening increases. Inspect leakage by checking the temperature and opening.</p> <ul style="list-style-type: none"> • Check pipe connections for gas leakage. <p>③Check the insulation.</p> <p>④Open suction grill and check the filter. Clean the filter by removing dirt or dust on it.</p> <p>⑤• If the filter is clogged, indoor pipe temperature rises and discharging pressure increases. Check if heat exchanger is clogged by inspecting discharging pressure.</p> <ul style="list-style-type: none"> • Clean the heat exchanger. <p>⑥Remove the shield.</p> <p>⑦Check refrigerant system during operation.</p>
<p>8. ①For 3 minutes after temperature adjuster turns off, the compressor will not start operating even if temperature adjuster is turned on.</p> <p>②For 3 minutes after temperature adjuster turns on, the compressor will not stop operating even if temperature adjuster is turned off. (Compressor stops operating immediately when turning off by the remote controller.)</p>	<p>①②Normal operation (For protection of compressor)</p>	<p>①②Normal operation</p>

HOW TO CHECK THE PARTS
PUHZ-RP3VHA PUAZ-RP5VHA
PUHZ-RP4VHA PUAZ-RP6VHA

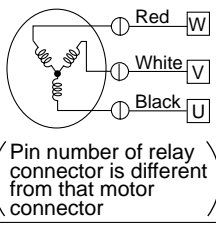
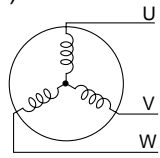
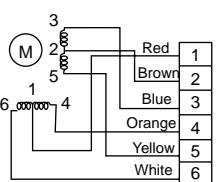
Parts name	Check points																			
Outdoor pipe <liquid> temperature thermistor (TH3) Discharge temperature thermistor (TH4) Outdoor condenser/ evaporator temperature thermistor (TH6) Outdoor outside temperature thermistor (TH7) Heat sink temperature thermistor (TH8)	Disconnect the connector then measure the resistance using a tester. (Surrounding temperature 10°C ~30°C) <table border="1"> <thead> <tr> <th></th> <th>Normal</th> <th>Abnormal</th> </tr> </thead> <tbody> <tr> <td>TH4</td> <td>160kΩ~410kΩ</td> <td rowspan="4">Open or short</td> </tr> <tr> <td>TH3</td> <td rowspan="3">4.3kΩ~9.6kΩ</td> </tr> <tr> <td>TH6</td> </tr> <tr> <td>TH7</td> </tr> <tr> <td>TH8</td> <td>39kΩ~105kΩ</td> </tr> </tbody> </table>		Normal	Abnormal	TH4	160kΩ~410kΩ	Open or short	TH3	4.3kΩ~9.6kΩ	TH6	TH7	TH8	39kΩ~105kΩ							
	Normal	Abnormal																		
TH4	160kΩ~410kΩ	Open or short																		
TH3	4.3kΩ~9.6kΩ																			
TH6																				
TH7																				
TH8	39kΩ~105kΩ																			
Fan motor(MF1,MF1)  (Pin number of relay connector is different from that motor connector)	Measure the resistance between the terminals using a tester. (Winding temperature 20°C) <table border="1"> <thead> <tr> <th>Relay connector</th> <th>Normal</th> <th>Abnormal</th> </tr> </thead> <tbody> <tr> <td>Red — Black</td> <td rowspan="3">15.1±0.5Ω</td> <td rowspan="3">Open or short</td> </tr> <tr> <td>Black — White</td> </tr> <tr> <td>White — Red</td> </tr> </tbody> </table>	Relay connector	Normal	Abnormal	Red — Black	15.1±0.5Ω	Open or short	Black — White	White — Red											
Relay connector	Normal	Abnormal																		
Red — Black	15.1±0.5Ω	Open or short																		
Black — White																				
White — Red																				
4-Way valve solenoid coil (21S4)	Measure the resistance between the terminals using a tester. (Surrounding temperature 20°C) <table border="1"> <thead> <tr> <th colspan="2">Normal</th> <th>Abnormal</th> </tr> </thead> <tbody> <tr> <td>PUHZ-RP3VHA</td> <td>PUHZ-RP4, 5, 6VHA</td> <td rowspan="2">Open or short</td> </tr> <tr> <td>2350±170Ω</td> <td>1370±100Ω</td> </tr> </tbody> </table>	Normal		Abnormal	PUHZ-RP3VHA	PUHZ-RP4, 5, 6VHA	Open or short	2350±170Ω	1370±100Ω											
Normal		Abnormal																		
PUHZ-RP3VHA	PUHZ-RP4, 5, 6VHA	Open or short																		
2350±170Ω	1370±100Ω																			
Compressor (MC) 	Measure the resistance between the terminals using a tester. (Winding temperature 20°C) <table border="1"> <thead> <tr> <th colspan="2">Normal</th> <th>Abnormal</th> </tr> </thead> <tbody> <tr> <td>PUHZ-RP3VHA</td> <td>PUHZ-RP4, 5, 6VHA</td> <td rowspan="2">Open or short</td> </tr> <tr> <td>0.865Ω~0.895Ω</td> <td>0.266Ω</td> </tr> </tbody> </table>	Normal		Abnormal	PUHZ-RP3VHA	PUHZ-RP4, 5, 6VHA	Open or short	0.865Ω~0.895Ω	0.266Ω											
Normal		Abnormal																		
PUHZ-RP3VHA	PUHZ-RP4, 5, 6VHA	Open or short																		
0.865Ω~0.895Ω	0.266Ω																			
Linear expansion valve (LEV-A/LEV-B) 	Disconnect the connector then measure the resistance using a tester. (Winding temperature 20°C) <table border="1"> <thead> <tr> <th colspan="4">Normal</th> <th>Abnormal</th> </tr> </thead> <tbody> <tr> <td>(1) - (6)</td> <td>(1) - (4)</td> <td>(2) - (5)</td> <td>(2) - (3)</td> <td rowspan="2">Open or short</td> </tr> <tr> <td>Red - White</td> <td>Red - Orange</td> <td>Brown - Yellow</td> <td>Brown - Blue</td> </tr> <tr> <td colspan="4">46±4Ω</td> <td></td> </tr> </tbody> </table>	Normal				Abnormal	(1) - (6)	(1) - (4)	(2) - (5)	(2) - (3)	Open or short	Red - White	Red - Orange	Brown - Yellow	Brown - Blue	46±4Ω				
Normal				Abnormal																
(1) - (6)	(1) - (4)	(2) - (5)	(2) - (3)	Open or short																
Red - White	Red - Orange	Brown - Yellow	Brown - Blue																	
46±4Ω																				
Bypass valve solenoid coil (SV)	Measure the resistance between the terminals using a tester. (Surrounding temperature 20°C) <table border="1"> <thead> <tr> <th>Normal</th> <th>Abnormal</th> </tr> </thead> <tbody> <tr> <td>1197±10Ω</td> <td>Open or short</td> </tr> </tbody> </table>	Normal	Abnormal	1197±10Ω	Open or short															
Normal	Abnormal																			
1197±10Ω	Open or short																			

HOW TO CHECK THE COMPONENTS

<Thermistor feature chart>

Low temperature thermistors

Outdoor pipe <liquid> temperature thermistor (TH3)
 Outdoor condenser/evaporator temperature thermistor (TH6)
 Outdoor outside temperature thermistor (TH7)

Thermistor R0 = 15kΩ ± 3%

B constant = 3480kΩ ± 2%

$$R_t = 15 \exp\left\{3480 \left(\frac{1}{273+t} - \frac{1}{273} \right)\right\}$$

0°C	15kΩ	30°C	4.3kΩ
10°C	9.6kΩ	40°C	3.0kΩ
20°C	6.3kΩ		
25°C	5.2kΩ		

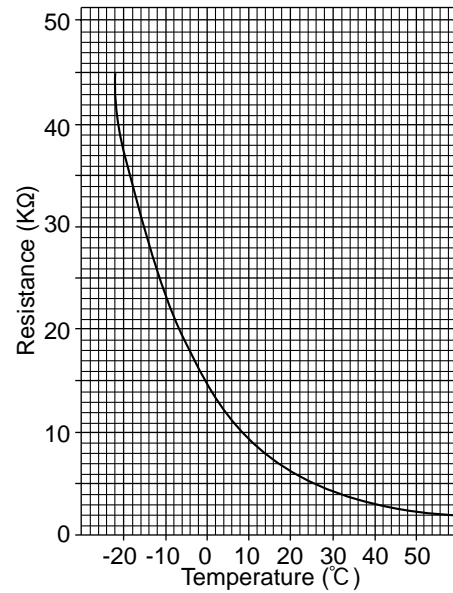

Medium temperature thermistor

Heat sink temperature thermistor (TH8)

Thermistor R50 = 17kΩ ± 2%

B constant = 4150kΩ ± 3%

$$R_t = 17 \exp\left\{4150 \left(\frac{1}{273+t} - \frac{1}{323} \right)\right\}$$

0°C	180kΩ
25°C	50kΩ
50°C	17kΩ
70°C	8kΩ
90°C	4kΩ

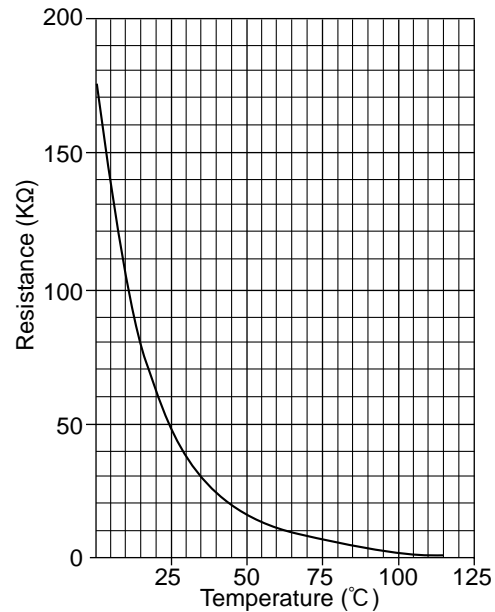

High temperature thermistor

Discharge temperature thermistor (TH4)

Thermistor R120 = 7.465kΩ ± 2%

B constant = 4057kΩ ± 2%

$$R_t = 7.465 \exp\left\{4057 \left(\frac{1}{273+t} - \frac{1}{393} \right)\right\}$$

20°C	250kΩ	70°C	34kΩ
30°C	160kΩ	80°C	24kΩ
40°C	104kΩ	90°C	17.5kΩ
50°C	70kΩ	100°C	13.0kΩ
60°C	48kΩ	110°C	9.8kΩ

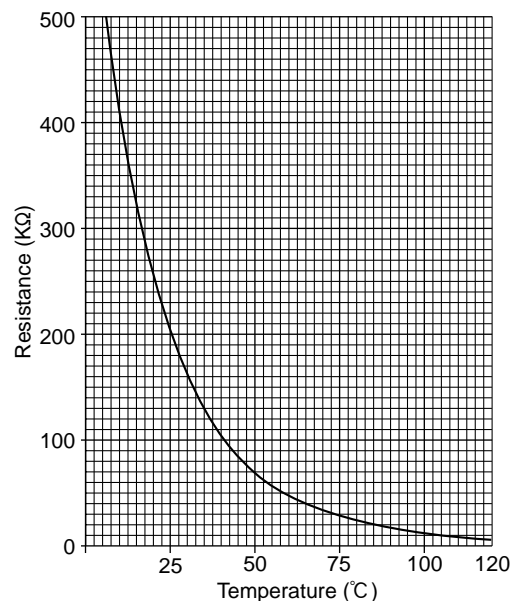

Linear expansion valve

① Operation summary of the linear expansion valve.

- Linear expansion valve open/close through stepping motor after receiving the pulse signal from the outdoor controller board.
 - Valve position can be changed in proportion to the number of pulse signal.
- <Connection between the indoor controller board and the linear expansion valve>

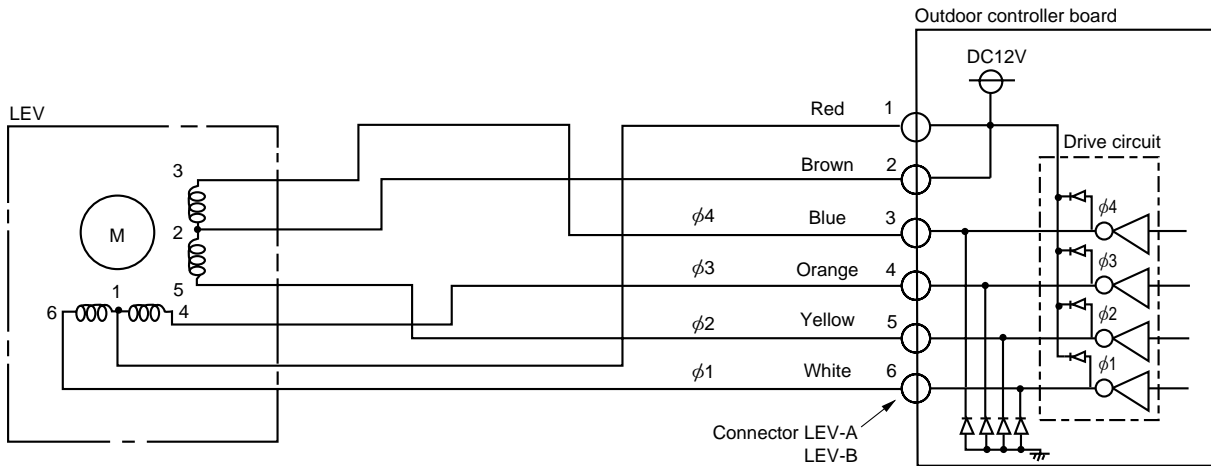

<Output pulse signal and the valve operation>

Output (Phase)	Output							
	1	2	3	4	5	6	7	8
$\phi 1$	ON	ON	OFF	OFF	OFF	OFF	OFF	ON
$\phi 2$	OFF	ON	ON	ON	OFF	OFF	OFF	OFF
$\phi 3$	OFF	OFF	OFF	ON	ON	ON	OFF	OFF
$\phi 4$	OFF	OFF	OFF	OFF	OFF	ON	ON	ON

Opening a valve : 8 → 7 → 6 → 5 → 4 → 3 → 2 → 1 → 8

Closing a valve : 1 → 2 → 3 → 4 → 5 → 6 → 7 → 8 → 1

The output pulse shifts in above order.

- * 1. When linear expansion valve operation stops, all output phase become OFF.
- * When the switch is turned on, 700 pulse closing valve signal will be sent till it goes to ㉞ point in order to define the valve position. (The pulse signal is being sent for about 20 seconds.)
- When the valve moves smoothly, there is no noise or vibration occurring from the linear expansion valve : however, when the pulse number moves from ㉞ to ㉞ or when the valve is locked, more noise can be heard than normal situation. No noise is heard when the pulse number moves from ㉞ to ㉞ in case coil is burn out or motor is locked by open-phase.
- * Noise can be detected by placing the ear against the screw driver handle while putting the screw driver to the linear expansion valve.

② Linear expansion valve operation

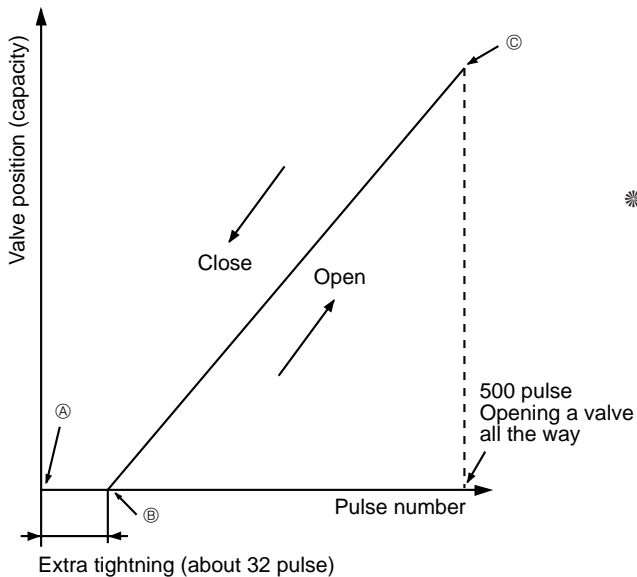

(3) How to attach and detach the coil of linear expansion valve

<Composition>

Linear expansion valve is separable into the main body and the coil as shown in the diagram below.

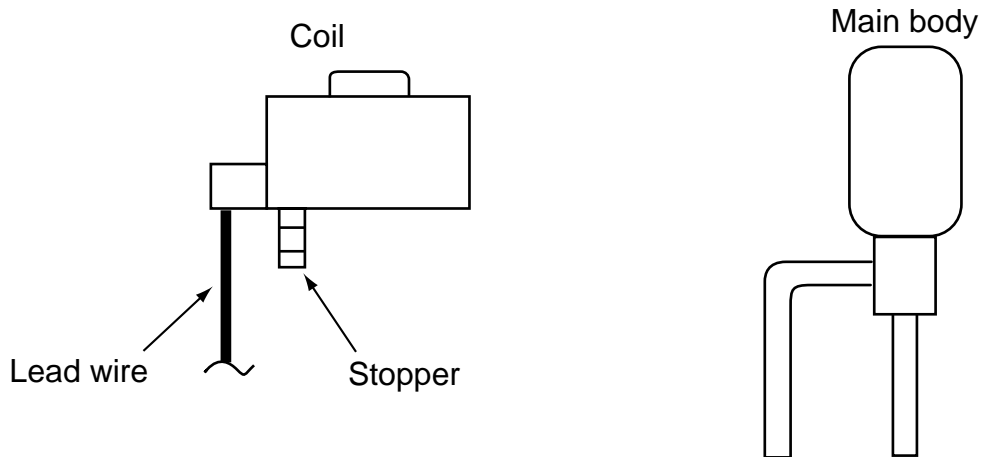

<How to detach the coil>

Hold the lower part of the main body (shown as A) firmly so that the main body does not move and detach the coil by pulling it upward.

Be sure to detach the coil holding main body firmly. Otherwise pipes can bend due to pressure.

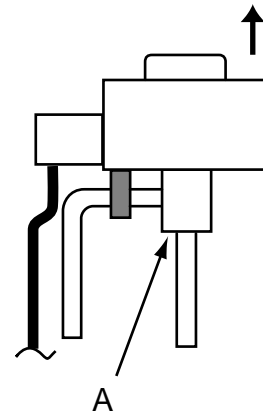

<How to attach the coil>

Hold the lower part of the main body (shown as A) firmly so that the main body does not move and attach the coil by inserting it downward into the main body. Then securely attach the coil stopper to pipe B. (At this time, be careful that stress is not added to lead wire and main body is not wound by lead wire.) If the stopper is not firmly attached to pipe B, coil may be detached from the main body and that can cause defective operation of linear expansion valve.

To prevent piping stress, be sure to attach the coil holding the main body of linear expansion valve firmly. Otherwise pipe may break.

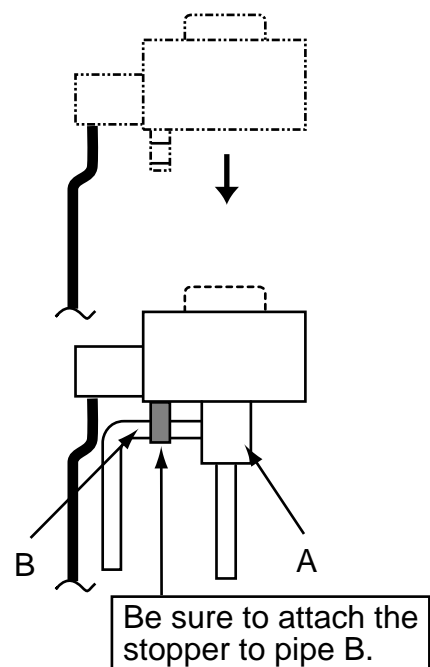

10-6. EMERGENCY OPERATION

(1) When the error codes shown below are displayed on outdoor unit or microcomputer for wired remote controller or indoor unit has a failure, but no other problems are found, emergency operation will be available by setting the emergency operation switch (SWE) to ON and short-circuiting the connector (CN31) on outdoor controller board.

●When following abnormalities occur, emergency operation will be available.

Error code	Inspected content
U4	Open/short of pipe thermistor (TH3/TH6)
E8	Indoor/outdoor unit communication error •Signal receiving error (Outdoor unit)
E9	Indoor/outdoor unit communication error •Transmitting error (Indoor unit)
E0 ~ E7	Communication error other than outdoor unit
Ed	Communication error between outdoor controller board and M-NET p.c. board (Serial communication error)

(2) Check the following items and cautions for emergency operation

- ①Make sure that there is no abnormality in outdoor unit other than the above abnormalities. (Emergency operation will not be available when error code other than the above are indicated.)
- ②For emergency operation, it is necessary to set the emergency operation switch (SWE) on indoor controller board. Refer to the electrical wiring diagram of indoor unit for how to set the indoor unit.)
- ③During emergency operation, the air-conditioner will continuously be operated by supplying power and stopping it: It can not be turned on or off by remote control, and temperature control is not possible.
- ④Do not perform emergency heating operation for an extended period of time: If the outdoor unit starts defrosting during this period, cold air will blow out from the indoor unit.
- ⑤Do not perform emergency cooling operation for more than 10 hours: Neglecting this could result in freezing the heat exchanger in indoor unit.

(3) Emergency operation procedure

- ①Turn the main power supply off.
- ②Turn on the emergency operation switch (SWE) on indoor controller board.
- ③Set the shorting pins of emergency operation connector (CN31) on outdoor controller board to ON.
- ④Use SW4-2 on outdoor controller board to set the operation mode (cooling or heating). (SW4-1 is not used.)

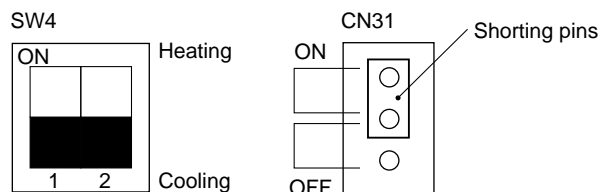

⑤Turning the main power supply on will start the emergency operation.

(4) Releasing emergency operation

- ①Turn the main power supply off.
- ②Set the emergency operation switch (SWE) on indoor controller board to OFF.
- ③Set the shorting pins of emergency operation connector (CN31) on outdoor controller board to OFF.
- ④Set SW4-2 on outdoor controller board as shown in the right.

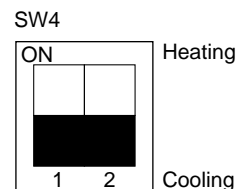

※If shorting pins are not set on emergency operation connector (CN31), the setting remains OFF.

10-7. TEST POINT DIAGRAM

Outdoor controller board

PUHZ-RP3VHA

PUHZ-RP4VHA

PUHZ-RP5VHA

PUHZ-RP6VHA

FAN12•FAN22
(FAN22 is only for RP4-6.)
Connect to fan motor
(Detection of position)
① to ⑤ DC 5V pulse
② to ⑤ (Detected while the motor is rotating.)
③ to ⑤

FAN11•FAN21
(FAN21 is only for RP4-6.)
Connect to fan motor.

CNS
Indoor/outdoor unit
connecting wire

Communication
power supply D71
Voltage developed
across: 16-30V

CNAC
① to ③: Power supply
(AC220V-240V)
⑤ to ⑦: Power supply
(AC220V-240V)

21S4
Four-way valve

63H
High pressure
protect switch

63L
Low pressure
protect switch
only for RP4-6

52C
52C relay signal
only for RP4-6

SV2
RP3: Bypass valve
RP4-6: Replace
valve

Power supply
(AC220-240V)

CN4
Transmission to
power board

CN52C
52C relay signal
(Noise filter board)
Only for RP3

LED1,LED2
Display of
operating
condition

SWP
Pump down
CN31
Emergency
operation

SW4
Test run
SW5
Power failure
automatic
recovery

CNDC
DC300-380V
Connect to
power board
LEV-A,LEV-B
Linear expansion
valve

Thermistor
Detection of out-
side temp

Thermistor
Detection of
Cond./Eva. temp

Thermistor
Detection of
liquid temp

Thermistor
Detection of
discharge temp

CNDM
① to ②: Input of silent mode
① to ③: Input of external
contact point

CNM
A-control service
tool

CNMNT
Connect to M-NET
adaptor

Control power
supply voltage 5V:
4.75-5.25V

J1~J6
Model selection

SW1
Forced defrosting
Cancellation of error code
Refrigerant address

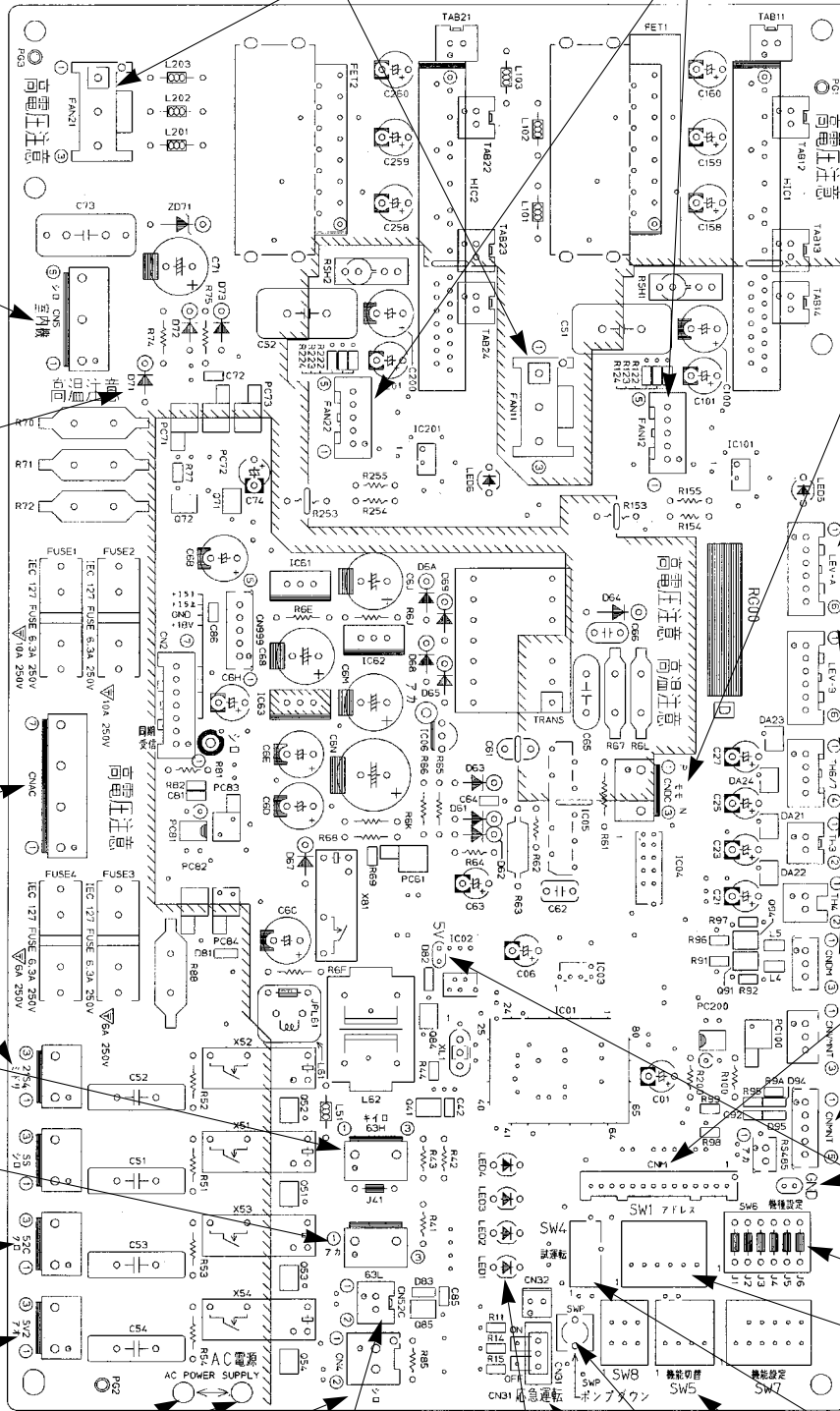

**Outdoor noise filter board
PUHZ-RP3VHA**

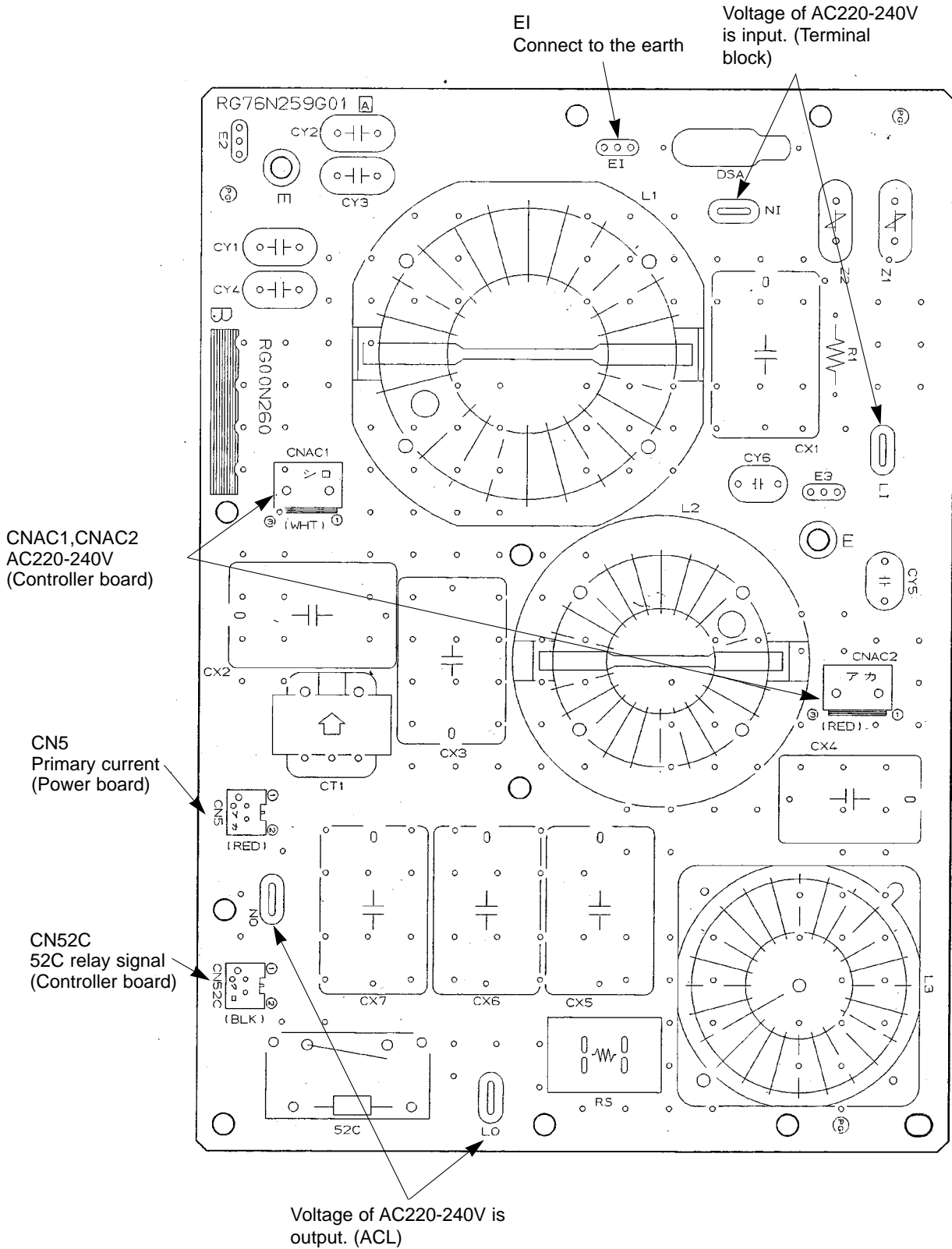

Outdoor noise filter board
PUHZ-RP4VHA
PUHZ-RP5VHA
PUHZ-RP6VHA

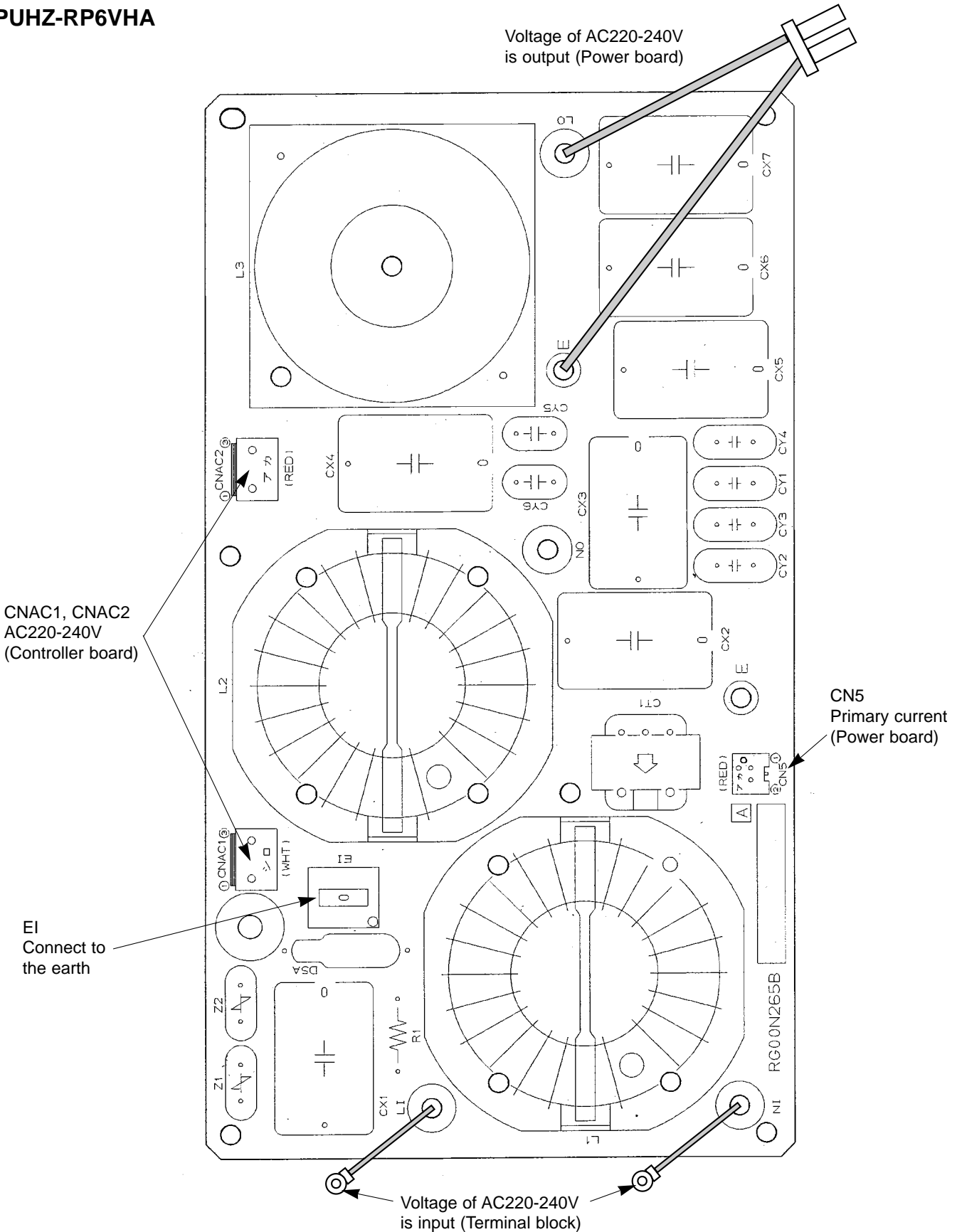

CNAC1, CNAC2
 AC220-240V
 (Controller board)

E1
 Connect to
 the earth

Voltage of AC220-240V
 is output (Power board)

CN5
 Primary current
 (Power board)

Voltage of AC220-240V
 is input (Terminal block)

Outdoor Power board PUHZ-RP3VHA

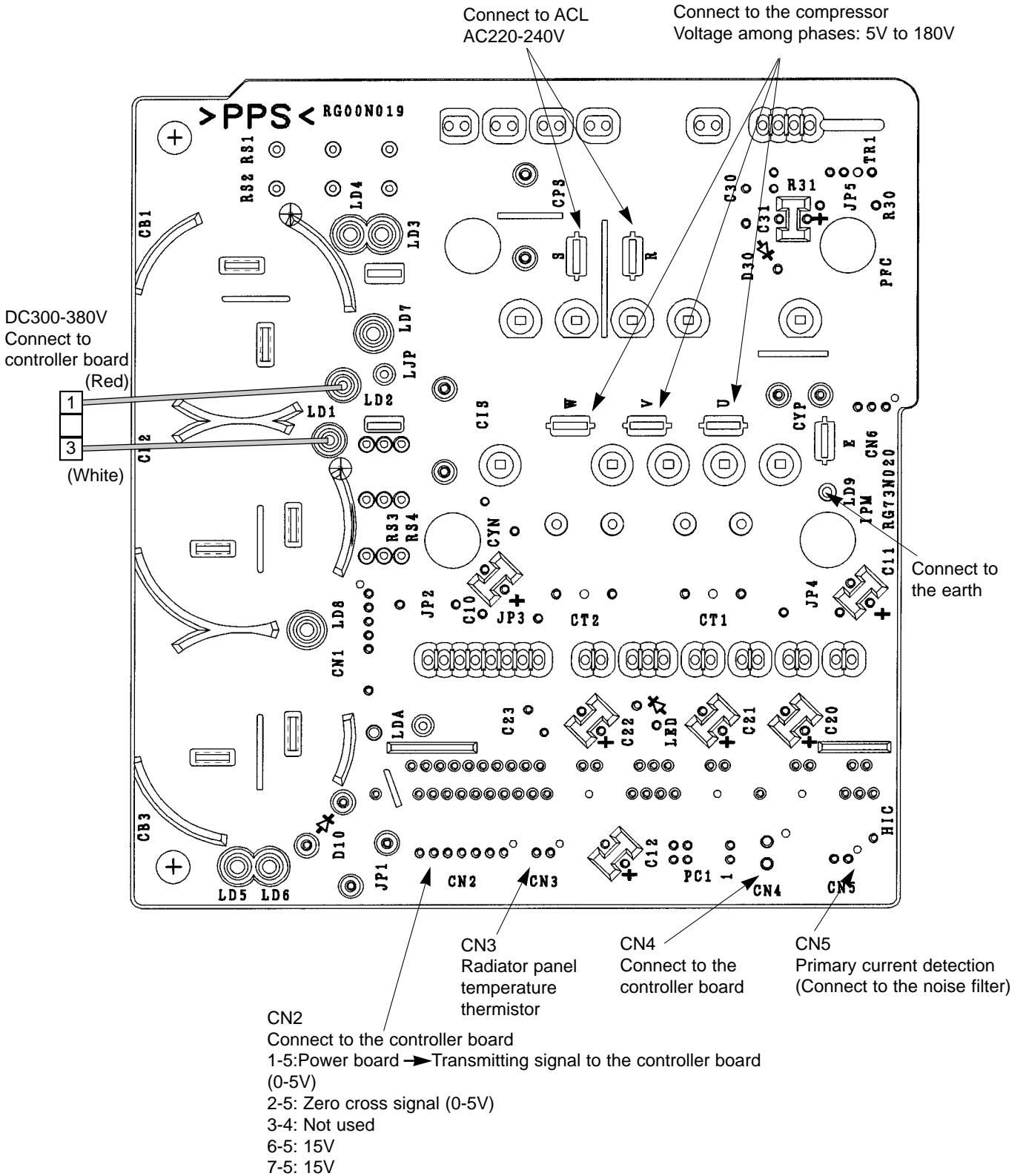

Outdoor Power board
PUHZ-RP4VHA
PUHZ-RP5VHA
PUHZ-RP6VHA

CN5
 Detection of primary current
 (Connect to the noise filter)

CN3
 Radiator panel
 temperature
 thermistor

CN4
 Connect to the
 controller board

CNAF
 Connect to
 ACTM

CN2
 Connect to the controller board
 1-5: Power board → Transmitting
 signal to the controller board (0-5V)
 2-5: Zero cross signal (0-5V)
 3-4: 18V
 6-5: 15V
 7-5: 15V

Connect to the
 compressor
 Voltage
 among
 phases:
 5V-180V

SC-R, SC-S
 Connect to the
 noise filter
 AC220V-240V

SC-P2, SC-N2
 Connect to
 ACTM and the
 soothing capacitor

SC-P1
 Connect to 52C

SC-N1
 Connect to ACTM

CNDC
 DC300V-370V

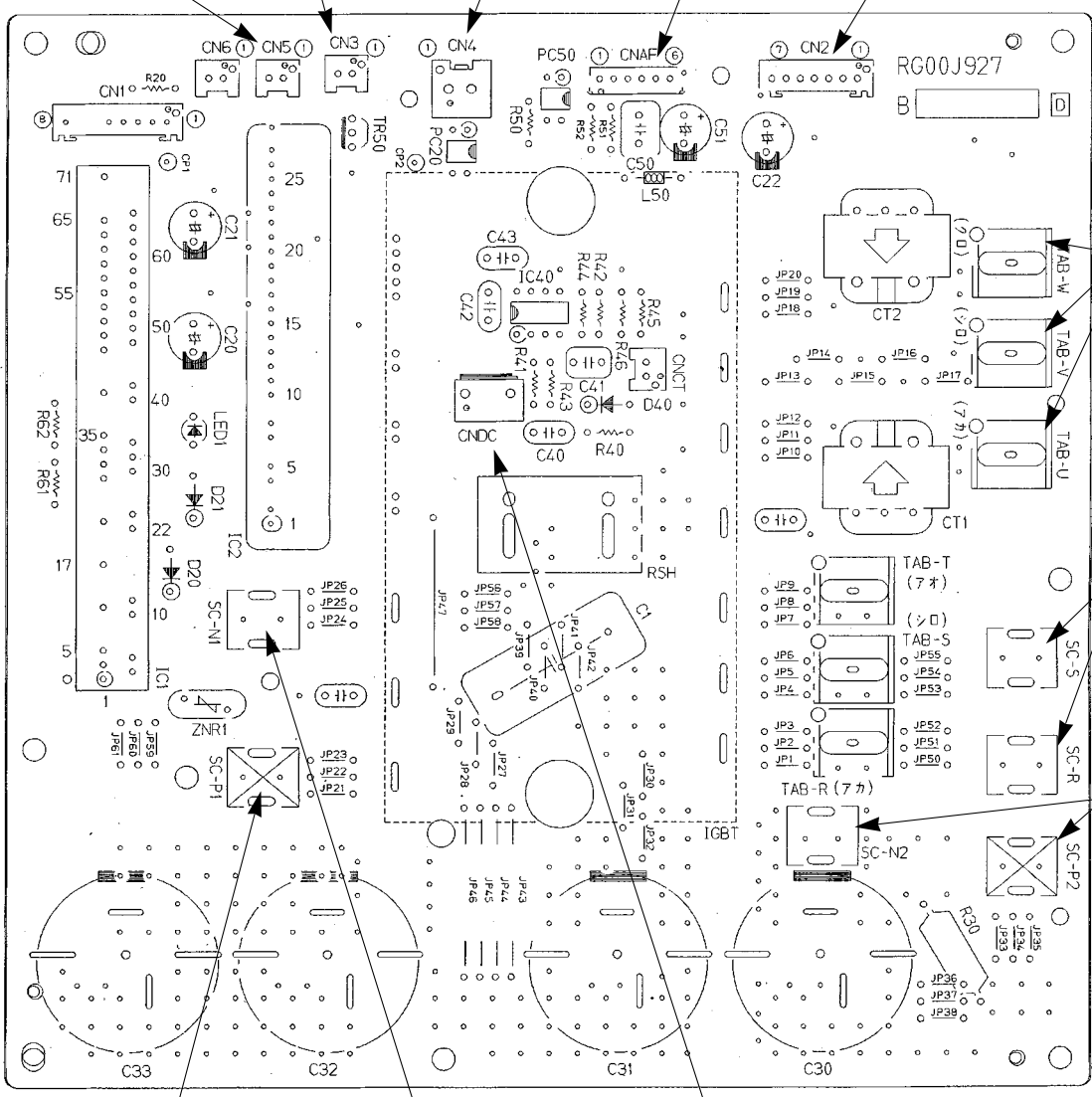

10-8. FUNCTION OF SWITCHES, CONNECTORS AND JUMPERS

(1) Function of switches

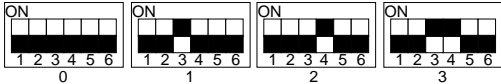
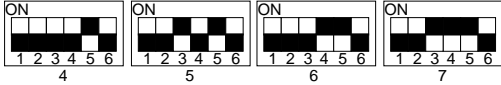
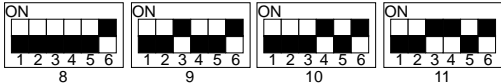
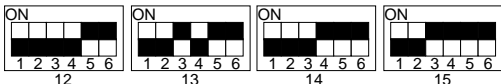
Type of switch	Switch	No.	Function	Action by the switch operation		Effective timing		
				ON	OFF			
Dip switch	SW1	1	Compulsory defrosting	Start	Normal	When compressor is working in heating operation. *		
		2	Abnormal history clear	Clear	Normal		off or operating	
		3	Refrigerant address setting					When power supply ON
		4						
		5						
		6						
	1	Test run		Operating	OFF	Under suspension		
	2	Test run mode setting	Heating	Cooling				

Compulsory defrosting should be done as follows.

- ① Change the DIP SW1-1 on the outdoor controller board from OFF to ON.
- ② Compulsory defrosting will start by the above operation ① if these conditions written below are satisfied.
 - Heat mode setting
 - 10 minutes have passed since compressor started operating or previous compulsory defrosting finished.
 - Pipe temperature is less than or equal to 8°C.
- ③ Compulsory defrosting will finish if certain conditions are satisfied.

*Compulsory defrosting can be done if above conditions are satisfied when DIP SW1-1 is changed from OFF to ON. After DIP SW1-1 is changed from OFF to ON, there is no problem if DIP SW1-1 is left ON or changed to OFF again. This depends on the service conditions.

Type of Switch	Switch	No.	Function	Action by the switch operation		Effective timing																						
				ON	OFF																							
Dip switch	SW5	1	No function	—	—	—																						
		2	Power failure automatic recovery *1	Auto recovery	No auto recovery	When power supply ON																						
		3	No function	—	—																							
		4	No function	—	—																							
	SW7	1	Switch to "Low-level Sound Priority Mode" *2	<table border="1"> <thead> <tr> <th>1</th> <th>2</th> <th>Low-level Sound Priority Mode</th> <th>Cooling</th> <th>Heating</th> </tr> </thead> <tbody> <tr> <td rowspan="2">OFF</td> <td>OFF</td> <td rowspan="2">Mode 1</td> <td>Regulate max Hz to spec.</td> <td>Regulate max Hz to spec.</td> </tr> <tr> <td>ON</td> <td>Regulate max Hz to spec.</td> <td>Regulate max Hz to spec.</td> </tr> <tr> <td rowspan="2">ON</td> <td>OFF</td> <td>Mode 2</td> <td>Regulate max Hz to spec.</td> <td>No regulation</td> </tr> <tr> <td>ON</td> <td>Mode 3</td> <td>Only TH7 ≧ 30°C regulate max Hz to spec.</td> <td>Regulate max Hz to spec.</td> </tr> </tbody> </table>		1	2	Low-level Sound Priority Mode	Cooling	Heating	OFF	OFF	Mode 1	Regulate max Hz to spec.	Regulate max Hz to spec.	ON	Regulate max Hz to spec.	Regulate max Hz to spec.	ON	OFF	Mode 2	Regulate max Hz to spec.	No regulation	ON	Mode 3	Only TH7 ≧ 30°C regulate max Hz to spec.	Regulate max Hz to spec.	Always
				1	2	Low-level Sound Priority Mode	Cooling	Heating																				
		OFF	OFF	Mode 1	Regulate max Hz to spec.	Regulate max Hz to spec.																						
			ON		Regulate max Hz to spec.	Regulate max Hz to spec.																						
		ON	OFF	Mode 2	Regulate max Hz to spec.	No regulation																						
			ON	Mode 3	Only TH7 ≧ 30°C regulate max Hz to spec.	Regulate max Hz to spec.																						
	2	No function	—	—																								
	3	No function	—	—																								
	4	No function	—	—																								
	5	No function	—	—																								
	6	No function	—	—																								
SW8	1	Use of existing pipe	Used	Not used	Always																							
	2	Replacement operation	Start	Normal	Under suspension																							
	3	No function	—	—	—																							
Push switch	SWP	Pump down	Start	Normal	Under suspension																							

*1 Power failure automatic recovery' can be set by either remote controller or this DIP SW. If one of them is set to ON, 'Auto recovery' activates. Please set "Auto recovery" basically by remote controller because all units have not DIP SW. Please refer to mode 01 in the table on page 61.

*2 SW7-1,2 to "Low-level Sound Priority Mode" available in "Low-level Sound Priority Mode" mode only.

(2) Function of connectors and jumpers

Types	Connector	Function	Action by open/ short operation		Effective timing																									
			Short	Open																										
Connector	CN31	Emergency operation	Start	Normal	When power supply ON																									
Jumper	J1	Power supply setting	3 phase	Single phase	Always																									
	J3	Capacity settings	○:Short ×:Open		Always																									
	J4		<table border="1" style="margin-left: auto; margin-right: auto;"> <thead> <tr> <th>Model \ Jumper</th> <th>J3</th> <th>J4</th> <th>J5</th> <th>J6</th> </tr> </thead> <tbody> <tr> <td>PUHZ-RP3VHA</td> <td>○</td> <td>×</td> <td>○</td> <td>×</td> </tr> <tr> <td>PUHZ-RP4VHA</td> <td>×</td> <td>○</td> <td>○</td> <td>×</td> </tr> <tr> <td>PUHZ-RP5VHA</td> <td>○</td> <td>○</td> <td>○</td> <td>×</td> </tr> <tr> <td>PUHZ-RP6VHA</td> <td>×</td> <td>×</td> <td>×</td> <td>○</td> </tr> </tbody> </table>			Model \ Jumper	J3	J4	J5	J6	PUHZ-RP3VHA	○	×	○	×	PUHZ-RP4VHA	×	○	○	×	PUHZ-RP5VHA	○	○	○	×	PUHZ-RP6VHA	×	×	×	○
	Model \ Jumper		J3	J4		J5	J6																							
	PUHZ-RP3VHA		○	×		○	×																							
PUHZ-RP4VHA	×	○	○	×																										
PUHZ-RP5VHA	○	○	○	×																										
PUHZ-RP6VHA	×	×	×	○																										
J5																														
J6																														

Special function

a) Low-level sound priority mode (Local wiring)

Unit enters into Low-level sound priority mode by SW7-1, 2 and external signal input setting.

Inputting external signals to the outdoor unit decreases the outdoor unit operation sound 3 to 4 dB lower than that of usual. Adding a commercial timer or on-off switch contactor setting to the CNDM connector which is optional contactor for Demand input located on the outdoor controller board enables to control compressor operation frequency. In Low-level sound priority mode, the maximum outdoor fan steps is regulated to 8 and the maximum operation frequency of the compressor is regulated to specified range in cool mode. In heating mode, the maximum compressor operation frequency is regulated to specified range.

* The performance is depends on the load of conditioned air of the room.

How to wiring

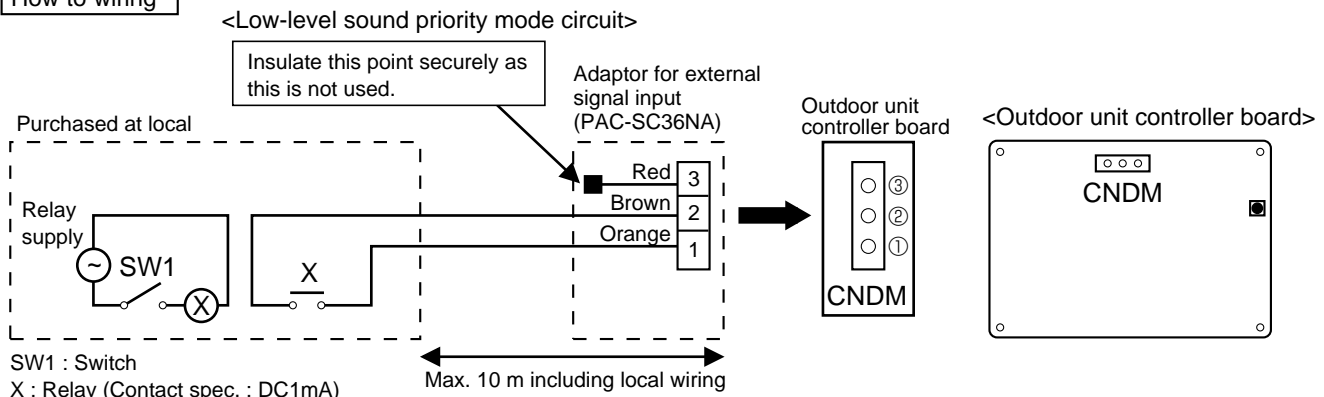

1) Make the circuit as shown above with Adaptor for external signal input(PAC-SC36NA).

2) Turn SW1 to on for Low-level sound priority mode.

Turn SW1 to off to release Low-level sound priority mode and normal operation.

(b) On demand control (Local wiring)

Demand control is available by external input. In this mode, the outdoor unit stops and indoor unit operates with fan mode.

* The setting of SW-7 is not required for the demand control.

How to wiring

Basically, the wiring is the same.

Connect an SW 1 which is procured at field to the between Orange and Red(1 and 3) of the Adaptor for external signal input(PAC-SC36NA), and insulate the tip of the brown lead wire.

<Display function of inspection for outdoor unit>

The blinking patterns of both LED1(green) and LED2(red) indicate the types of abnormality when it occurs. Types of abnormality can be indicated in details by connecting an optional part 'A-Control Service Tool (PAC-SK52ST)' to connector CNM on outdoor controller board.

[Display] (1)Normal condition

Unit condition	Outdoor controller board		A-Control Service Tool	
	LED1 (Green)	LED2 (Red)	Error code	Indication of the display
When the power is turned on	Lighted	Lighted	— ↔ —	Alternately blinking display
When unit stops	Lighted	Not lighted	00, etc.	Operation mode
When compressor is warming up	Lighted	Not lighted	08, etc.	
When unit operates	Lighted	Lighted	C5, H7 etc.	

(2)Abnormal condition

Indication		Error				
Outdoor controller board		Contents	Error code ※1	Inspection method	Detailed reference page	
LED1 (Green)	LED2 (Red)					
1 blinking	2 blinking	Connector(63L) is open.	F3	①Check if connector (63L or 63H) on the outdoor controller board is not disconnected. ②Check continuity of pressure switch (63L or 63H) by tester.	P.28	
		Connector(63H) is open.	F5		P.28	
		2 connectors are open.	F9		P.28	
2 blinking	1 blinking	Mis-wiring of indoor/outdoor unit connecting wire, excessive number of indoor units (4 units or more)	—	①Check if indoor/outdoor connecting wire is connected correctly. ②Check if 4 or more indoor units are connected to outdoor unit. ③Check if noise entered into indoor/outdoor connecting wire or power supply. ④Re-check error by turning off power, and on again.	P.29	
		Mis-wiring of indoor/outdoor unit connecting wire (converse wiring or disconnection)	—		P.29	
		Startup time over	—		P.29	
	2 blinking	2 blinking	Indoor/outdoor unit communication error (signal receiving error) is detected by indoor unit.	E6	①Check if indoor/outdoor connecting wire is connected correctly. ②Check if noise entered into indoor/outdoor connecting wire or power supply. ③Check if noise entered into indoor/outdoor controller board. ④Re-check error by turning off power, and on again.	※2
			Indoor/outdoor unit communication error (transmitting error) is detected by indoor unit.	E7		※2
			Indoor/outdoor unit communication error (signal receiving error) is detected by outdoor unit.	—		P.32
			Indoor/outdoor unit communication error (transmitting error) is detected by outdoor unit.	—		P.33
	3 blinking	3 blinking	Remote controller signal receiving error is detected by remote controller.	E0	①Check if connecting wire of indoor unit or remote controller is connected correctly. ②Check if noise entered into transmission wire of remote controller. ③Re-check error by turning off power, and on again.	P.32
			Remote controller transmitting error is detected by remote controller.	E3		P.32
			Remote controller signal receiving error is detected by indoor unit.	E4		※2
			Remote controller transmitting error is detected by indoor unit.	E5		※2
	4 blinking	4 blinking	Error code is not defined.	EF	①Check if remote controller is MA remote controller(PAR-20MAA). ②Check if noise entered into transmission wire of remote controller. ③Check if noise entered into indoor/outdoor connecting wire. ④Re-check error by turning off power, and on again.	P.33
5 blinking	5 blinking	Serial communication error <Communication between outdoor controller board and outdoor power board> <Communication between outdoor controller board and M-NET p.c. board>	Ed	①Check if connector (CN4) on outdoor controller board and outdoor power board is not disconnected. ②Check if there is poor connection of connector on outdoor controller board(CNMNT and CNVMNT). ③Check M-NET communication signal.	P.33	
		Communication error of high prior signal(M-NET)	A0-A8		P.34~ P.36	

※1.Remote controller displays error code.

※2.Refer to service manual for indoor unit.



Indication		Error			
Outdoor controller board		Contents	Error code ※1	Inspection method	Detailed reference page
LED1 (Green)	LED2 (Red)				
3 blinking	1 blinking	Abnormality of shell thermostat and discharging temperature (TH4)	U2	①Check if stop valves are open. ②Check if connectors (TH4, LEV-A, and LEV-B) on outdoor controller board are not disconnected.	P.30
		Abnormality of super heat due to low discharge temperature	U7	③Check if unit fills with specified amount of refrigerant. ④Measure resistance values among terminals on indoor valve and outdoor linear expansion valve using a tester.	P.31
	2 blinking	Abnormal high pressure (High pressure switch 63H worked.)	U1	①Check if indoor/outdoor units have a short cycle on their air ducts. ②Check if connector (63H) on outdoor controller board is not disconnected. ③Check if heat exchanger and filter is not dirty. ④Measure resistance values among terminals on linear expansion valve using a tester.	P.30
	4 blinking	Compressor over current breaking (Start-up locked)	UF	①Check if stop valves are open.	P.32
		Compressor over current breaking	UP	②Check looseness, disconnection, and converse connection of compressor wiring. ③Measure resistance values among terminals on compressor using a tester.	P.32
		Abnormality of current sensor (P.B.)	UH	④Check if outdoor unit has a short cycle on its air duct.	P.32
	5 blinking	Abnormality of power module	U6		P.31
		Open/short of discharge thermistor (TH4)	U3	①Check if connectors (TH3, TH4, TH6 and TH7) on outdoor controller board and connector (CN3) on outdoor power board are not disconnected.	P.30
		Open/short of outdoor thermistors (TH3, TH6, TH7 and TH8)	U4	②Measure resistance value of outdoor thermistors.	P.30
	6 blinking	Open/short of outdoor thermistor (TH8)			
6 blinking		Abnormality of radiator panel temperature	U5	①Check if indoor/outdoor units have a short cycle on their air ducts. ②Measure resistance value of outdoor thermistor(TH8).	P.31
7 blinking	Abnormality of voltage	U9	①Check looseness, disconnection, and converse connection of compressor wiring. ②Measure resistance value among terminals on compressor using a tester. ③Check the continuity of contactor (52C). ④Check if power supply voltage decreases. ⑤Check the wiring of CN52C. ⑥Check the wiring of CNAF. (RP4~6VHA only)	P.31	
4 blinking	1 blinking	Abnormality of room temperature thermistor (TH1)	P1	①Check if connectors (CN20, CN21 and CN29) on indoor controller board are not disconnected.	※2
		Abnormality of pipe temperature thermistor /Liquid (TH2)	P2	②Measure resistance value of indoor thermistors.	※2
		Abnormality of pipe temperature thermistor/Condenser-Evaporator	P9		※2
	2 blinking	Abnormality of drain sensor (DS)	P4	①Check if connector (CN31) on indoor controller board is not disconnected. ②Measure resistance value of indoor thermistors.	※2
		Indoor drain overflow protection	P5	③Measure resistance value among terminals on drain-up machine using a tester. ④Check if drain-up machine works. ⑤Check drain function.	
	3 blinking	Freezing (cooling)/overheating (heating) protection	P6	①Check if indoor unit has a short cycle on its air duct. ②Check if heat exchanger and filter is not dirty. ③Measure resistance value on indoor and outdoor fan motors. ④Check if the inside of refrigerant piping is not clogged.	※2
	4 blinking	Abnormality of pipe temperature	P8	①Check if indoor thermistors (TH2 and TH5) are not disconnected from holder. ②Check if stop valve is open. ③Check converse connection of extension pipe. (on plural units connection) ④Check if indoor/outdoor connecting wire is connected correctly. (on plural units connection)	※2

※1 Error code displayed on remote controller ※3 LED1 on power board for RP4, RP5 and RP6

※2 Refer to service manual for indoor unit. 1 blink: Power is supplied. 3 blinks: Power is supplied to warm up compressor.
2 blinks: Power is supplied to compressor. Blinking: Limited control is being performed.

LED indications of fan operating condition (LED5 and LED6 on controller board)

Operation	LED5/LED6 (Red)	Contents
Normal (Stop)	Lit	Fan stops.
Normal (Operating)		Controller board is outputting waveform for fan driving.

Operation	LED5/LED6 (Red)	Importance	Meaning of error code and detection method	Remark
Abnormal is detected	2 blinks	1	Abnormality of bus voltage: Abnormal if bus voltage inspected for 1.5msec. is less than 60V or more than 390V.	These LEDs are not used for service.
	6 blinks	2	Abnormality of overcurrent: Abnormal if current value of DC bus in fan controller board is over the cut-off point.	
	7 blinks	3	Abnormality of startup failure: Abnormal if the operating speed does not reach 100rpm even 12 sec passed after startup.	
	8 blinks	4	Abnormality of position detection: Abnormal if the position of U-phase cannot be detected after starting up fan.	
		5	Abnormality of disconnection: Abnormal if the first pattern of U/V/W-phase position detected after startup is H/H/H or L/L/L.	

<Outdoor unit operation monitor function>

[When option part 'A-Control Service Tool(PAC-SK52ST)' is connected to outdoor controller board(CNM)]

Digital indicator LED1 displays 2 digit number or code to inform operation condition and the meaning of error code by controlling DIP SW2 on 'A-Control Service Tool'.

Operation indicator SW2 : Indicator change of self diagnosis

SW2 setting	Display detail	Explanation for display	Unit
			

<Digital indicator LED1 working details>

(Be sure the 1 to 6 in the SW2 are set to OFF.)

- (1) Display when the power supply ON.
When the power supply ON, blinking displays by turns.
Wait for 4 minutes at the longest.

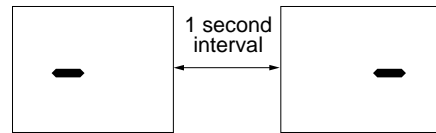

- (2) When the display lights. (Normal operation)
① Operation mode display.

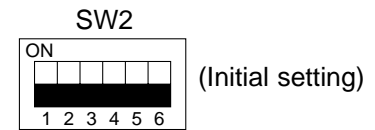
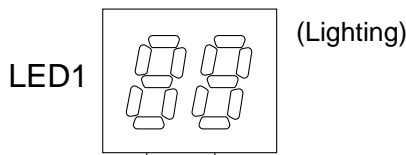

The tens digit : Operation mode

Display	Operation Model
O	OFF / FAN
C	COOLING / DRY *
H	HEATING
d	DEFROSTING

*C5 is displayed during replacement operation. <RP4~6VHA only>

② Display during error postponement
Postponement code is displayed when compressor stops due to the work of protection device.

Postponement code is displayed while error is being postponed.

- (3) When the display blinks
Inspection code is displayed when compressor stops due to the work of protection devices.

The ones digit : Relay output

Display	Warming-up Compressor	Compressor	4-way valve	Solenoid valve
0	—	—	—	—
1	—	—	—	ON
2	—	—	ON	—
3	—	—	ON	ON
4	—	ON	—	—
5	—	ON	—	ON
6	—	ON	ON	—
7	—	ON	ON	ON
8	ON	—	—	—
A	ON	—	ON	—

Display	Inspection unit
0	Outdoor unit
1	Indoor unit 1
2	Indoor unit 2
3	Indoor unit 3

Display	Contents to be inspected (During operation)
U1	Abnormal high pressure (63H worked)
U2	Abnormal high discharging temperature, shortage of refrigerant
U3	Open/short circuit of discharging thermistor(TH4)
U4	Open/short of outdoor unit thermistors(TH3, TH6, TH7 and TH8)
U5	Abnormal temperature of heat sink
U6	Abnormality of power module
U7	Abnormality of super heat due to low discharge temperature
UF	Compressor overcurrent interruption (When Comp. locked)
UH	Current sensor error
UL	Abnormal low pressure (63L worked)
UP	Compressor overcurrent interruption
P1~P8	Abnormality of indoor units
A0~A7	Communication error of high-prior signal (M-NET)

Display	Contents to be inspected (When power is turned on)
F3	63L connector(red) is open.
F5	63H connector(yellow) is open.
F9	2 connectors (63H/63L) are open.
E8	Indoor/outdoor communication error (Signal receiving error) (Outdoor unit)
E9	Indoor/outdoor communication error (Transmitting error) (Outdoor unit)
EA	Mis-wiring of indoor/outdoor unit connecting wire, excessive number of indoor units (4 units or more)
Eb	Mis-wiring of indoor/outdoor unit connecting wire(converse wiring or disconnection)
Ec	Startup time over
E0~E7	Communication error except for outdoor unit



SW2 setting	Display detail	Explanation for display	Unit
	Pipe temperature / Liquid (TH3) - 40~90	- 40~90 (When the coil thermistor detects 0°C or below, “-” and temperature are displayed by turns.) (Example) When -10°C; 0.5 secs. 0.5secs. 2 secs. -□ → 10 → □□	°C
	Discharge temperature (TH4) 3~217	3~217 (When the discharge thermistor detects 100°C or more, hundreds digit, tens digit and ones digit are displayed by turns.) (Example) When 105°C; 0.5 secs. 0.5secs. 2 secs. □1 → 05 → □□	°C
	Output step of outdoor FAN 0~10	0~10	Step
	The number of ON / OFF times of compressor 0~9999	0~9999 (When the number of times is 100 or more, hundreds digit, tens digit and ones digit are displayed by turns.) (Example) When 42500 times (425 X100 times); 0.5 secs. 0.5secs. 2 secs. □4 → 25 → □□	100 times
	Compressor integrating operation times 0~9999	0~9999 (When it is 100 hours or more, hundreds digit, tens digit and ones digit are displayed by turns.) (Example) When 2450 hours (245 X10 hours); 0.5 secs. 0.5secs. 2 secs. □2 → 45 → □□	10 hours
	Compressor operating current. 0~50	0~50 *Omit the figures after the decimal fractions.	A
	Compressor operating frequency 0~225	0~255 (When it is 100Hz or more, hundreds digit, tens digit and ones digit are displayed by turns.) (Example) When 125Hz; 0.5 secs. 0.5secs. 2 secs. □1 → 25 → □□	Hz
	LEV-A opening pulse 0~480	0~480 (When it is 100 pulse or more, hundreds digit, tens digit and ones digit are displayed by turns.) (Example) When 150 pulse; 0.5 secs. 0.5secs. 2 secs. □1 → 50 → □□	Pulse
	Error postponement code history (1) of outdoor unit	Postponement code display Blinking: During postponement Lighting: Cancellation of postponement “00” is displayed in case of no postponement.	Code display
	Operation mode on error occurring	Operation mode of when operation stops due to error is displayed by setting SW2 like below. (SW2)	Code display



SW2 setting	Display detail	Explanation for display	Unit
	Pipe temperature / Liquid(TH3) on error occurring - 40~90	- 40~90 (When the coil thermistor detects 0°C or below, “-” and temperature are displayed by turns.) (Example) When -15°C; 0.5 secs. 0.5secs. 2 secs. -□ → 15 → □□ ↑	°C
	Compressor temperature (TH4) or discharge temperature (TH4) on error occurring 3~217	3~217 (When the temperature is 100°C or more, the hundreds digit, tens digit and ones digit are displayed by turns.) (Example) When 130°C; 0.5 secs. 0.5secs. 2 secs. □1 → 30 → □□ ↑	°C
	Compressor operating current on error occurring 0~20	0~20	A
	Error code history (1) (latest) Alternate display of abnormal unit number and code	When no error history, “ 0 ” and “ - - ” are displayed by turns.	Code display
	Error code history (2) Alternate display of error unit number and code	When no error history, “ 0 ” and “ - - ” are displayed by turns.	Code display
	Thermo ON time 0~999	0~999 (When it is 100 minutes or more, the hundreds digit, tens digit and ones digit are displayed by turns.) (Example) When 245 minutes; 0.5 secs. 0.5secs. 2 secs. □2 → 45 → □□ ↑	Minute
	Test run elapsed time 0~120	0~120 (When it is 100 minutes or more, the hundreds digit, tens digit and ones digit are displayed by turns.) (Example) When 105 minutes; 0.5 secs. 0.5secs. 2 secs. □1 → 05 → □□ ↑	Minute



SW2 setting	Display detail	Explanation for display	Unit										
	The number of connected indoor units	0~3 (The number of connected indoor units are displayed.)	Unit										
	Capacity setting display	Displayed as an outdoor capacity code. <table border="1" style="margin-left: 20px;"> <thead> <tr> <th>Capacity</th> <th>Code</th> </tr> </thead> <tbody> <tr> <td>RP3V</td> <td>14</td> </tr> <tr> <td>RP4V</td> <td>20</td> </tr> <tr> <td>RP5V</td> <td>25</td> </tr> <tr> <td>RP6V</td> <td>28</td> </tr> </tbody> </table>	Capacity	Code	RP3V	14	RP4V	20	RP5V	25	RP6V	28	Code display
Capacity	Code												
RP3V	14												
RP4V	20												
RP5V	25												
RP6V	28												
	Outdoor unit setting information	<ul style="list-style-type: none"> The tens digit (Total display for applied setting) <table border="1" style="margin-left: 20px;"> <thead> <tr> <th>Setting details</th> <th>Display details</th> </tr> </thead> <tbody> <tr> <td>H-P / Cooling only</td> <td>0 : H-P 1 : Cooling only</td> </tr> <tr> <td>Single phase / Three phase</td> <td>0 : Single phase 2 : Three phase</td> </tr> </tbody> </table> The ones digit <table border="1" style="margin-left: 20px;"> <thead> <tr> <th>Setting details</th> <th>Display details</th> </tr> </thead> <tbody> <tr> <td>Defrosting switch</td> <td>0 : Normal 1 : For high humidity</td> </tr> </tbody> </table> <p>(Example) When heat pump, three phase and defrosting (normal) are set up, "20" is displayed.</p>	Setting details	Display details	H-P / Cooling only	0 : H-P 1 : Cooling only	Single phase / Three phase	0 : Single phase 2 : Three phase	Setting details	Display details	Defrosting switch	0 : Normal 1 : For high humidity	Code display
Setting details	Display details												
H-P / Cooling only	0 : H-P 1 : Cooling only												
Single phase / Three phase	0 : Single phase 2 : Three phase												
Setting details	Display details												
Defrosting switch	0 : Normal 1 : For high humidity												
	Indoor pipe temperature / Liquid (TH2(1)) Indoor 1 – 39~88	– 39~88 (When the temperature is 0°C or less, "–" and temperature are displayed by turns.)	°C										
	Indoor pipe temperature / Cond. / Eva. (TH5(1)) Indoor 1 – 39~88	– 39~88 (When the temperature is 0°C or less, "–" and temperature are displayed by turns.)	°C										
	Indoor pipe temperature / Liquid (TH2(2)) Indoor 2 – 39~88	– 39~88 (When the temperature is 0°C or less, "–" and temperature are displayed by turns.)	°C										
	Indoor pipe temperature / Cond. / Eva. (TH5(2)) Indoor 2 – 39~88	– 39~88 (When the temperature is 0°C or less, "–" and temperature are displayed by turns.)	°C										
	Indoor room temperature (TH1) 8~39	8~39	°C										



SW2 setting	Display detail	Explanation for display	Unit
	Indoor setting temperature 17~30	17~30	°C
	Outdoor pipe temperature / Cond./ Eva. (TH6) -39~88	-39~88 (When the temperature is 0°C or less, “-” and temperature are displayed by turns.)	°C
	Outdoor outside temperature (TH7) -39~88	-39~88 (When the temperature is 0°C or less, “-” and temperature are displayed by turns.)	°C
	Outdoor heat sink temperature (TH8) -40~200	-40~200 (When the temperature is 0°C or less, “-” and temperature are displayed by turns.) (When the thermistor detects 100°C or more, hundreds digit, tens digit and ones digit are displayed by turns.)	°C
	Discharge super heat. SHd 0~255 [Cooling = TH4-TH6] [Heating = TH4-TH5]	0~255 (When the temperature is 100°C or more, hundreds digit, tens digit and ones digit are displayed by turns.)	°C
	Sub cool. SC 0~130 [Cooling = TH6-TH3] [Heating = TH5-TH4]	0~130 (When the temperature is 100°C or more, hundreds digit, tens digit and ones digit are displayed by turns.)	°C
	Input current of outdoor unit	0~500 (When it is 100 or more, hundreds digit, tens digit and ones digit are displayed by turns.)	0.1 A
	LEV-B opening pulse	0~480 (When it is 100 pulse or more, hundreds digit, tens digit and ones digit are displayed by turns.)	Pulse
	Targeted operation frequency 0~255	0~255 (When it is 100Hz or more, hundreds digit, tens digit and ones digit are displayed by turns.)	Hz
	DC bus voltage 180~370	180~370 (When it is 100V or more, hundreds digit, tens digit and ones digit are displayed by turns.)	V

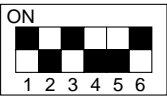
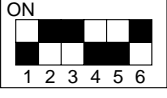
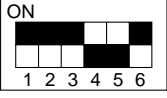
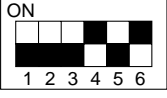
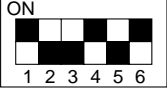
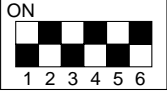
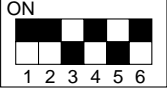

SW2 setting	Display detail	Explanation for display	Unit
	<p>Capacity save 0~255 When air conditioner is connected to M-NET and capacity save mode is demanded, "0"~"100" is displayed.</p> <p>[When there is no setting of capacity save "100" is displayed.]</p>	<p>0~100 (When the capacity is 100% hundreds digit, tens digit and ones digit are displayed by turns.) (Example) When 100%; 0.5 secs. 0.5secs. 2 secs. □1 → 00 → □□</p>	%
	<p>Error postponement code history (2) of outdoor unit</p>	<p>Postponement code display Blinking: During postponement Lighting: Cancellation of postponement "00" is displayed in case of no postponement.</p>	Code display
	<p>Error postponement code history (3) of outdoor unit</p>	<p>Postponement code display Blinking: During postponement Lighting: Cancellation of postponement "00" is displayed in case of no postponement.</p>	Code display
	<p>Error code history (3) (Oldest) Alternate display of abnormal unit number and code.</p>	<p>When no error history, "0" and "--" are displayed by turns.</p>	Code display
	<p>Error thermistor display</p> <p>[When there is no error thermistor, "--" is displayed.]</p>	<p>3: Outdoor pipe temperature /Liquid (TH3) 6: Outdoor pipe temperature /Cond./Eva. (TH6) 7: Outdoor outside temperature (TH7) 8: Outdoor radiator panel (TH8)</p>	Code display
	<p>Operation frequency on error occurring 0~255</p>	<p>0~255 (When it is 100Hz or more, hundreds digit, tens digit and ones digit are displayed by turns.) (Example) When 125Hz; 0.5 secs. 0.5secs. 2 secs. □1 → 25 → □□</p>	Hz
	<p>Fan step on error occurring 0~10</p>	<p>0~10</p>	Step



SW2 setting	Display detail	Explanation for display	Unit
	LEV-A opening pulse on error occurring 0~480	0~480 (When it is 100 pulse or more, hundreds digit, tens digit and ones digit are displayed by turns.) (Example) When 130 pulse; 0.5 secs. 0.5secs. 2 secs. □1 → 30 → □□	Pulse
	Indoor room temperature (TH1) on error occurring 8~39	8~39	℃
	Indoor pipe temperature / Liquid (TH2) on error occurring -39~88	-39~88 (When the temperature is 0℃ or less, “-” and temperature are displayed by turns.) (Example) When -15℃; 0.5 secs. 0.5secs. 2 secs. -□ → 15 → □□	℃
	Indoor pipe temperature / Cond./ Eva. (TH5) on error occurring -39~88	-39~88 (When the temperature is 0℃ or less, “-” and temperature are displayed by turns.) (Example) When -15℃; 0.5 secs. 0.5secs. 2 secs. -□ → 15 → □□	℃
	Outdoor pipe temperature / Cond./ Eva. (TH6) on error occurring -39~88	-39~88 (When the temperature is 0℃ or less, “-” and temperature are displayed by turns.) (Example) When -15℃; 0.5 secs. 0.5secs. 2 secs. -□ → 15 → □□	℃
	Outdoor outside temperature (TH7) on error occurring -39~88	-39~88 (When the temperature is 0℃ or less, “-” and temperature are displayed by turns.) (Example) When -15℃; 0.5 secs. 0.5secs. 2 secs. -□ → 15 → □□	℃
	Outdoor heat sink temperature (TH8) on error occurring -40~200	-40~200 (When the temperature is 0℃ or less, “-” and temperature are displayed by turns.) (When the temperature is 100℃ or more, hundreds digit, tens digit and ones digit are displayed by turns.)	℃

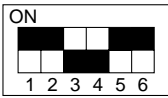
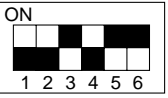
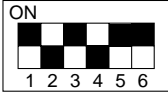
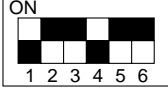
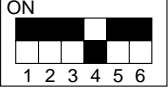
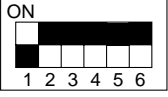

SW2 setting	Display detail	Explanation for display	Unit
	Discharge super heat on error occurring SHd 0~255 [Cooling = TH4-TH6] [Heating = TH4-TH5]	0~255 (When the temperature is 100°C or more, hundreds digit, tens digit and ones digit are displayed by turns.) (Example) When 150°C; 0.5 secs. 0.5secs. 2 secs. □1 → 50 → □□	°C
	Sub cool on error occurring. SC 0~130 [Cooling = TH6-TH3] [Heating = TH5-TH2]	0~130 (When the temperature is 100°C or more, hundreds digit, tens digit and ones digit are displayed by turns.) (Example) When 115°C; 0.5 secs. 0.5secs. 2 secs. □1 → 15 → □□	°C
	Thermo-on time until error stops 0~999	0~999 (When it is 100 minutes or more, hundreds digit, tens digit and ones digit are displayed by turns.) (Example) When 415 minutes; 0.5 secs. 0.5secs. 2 secs. □4 → 15 → □□	Minute
	Indoor pipe temperature / Liquid (TH2 (3)) Indoor 3 -39~88	-39~88 (When the temperature is 0°C or less, “-” and temperature are displayed by turns.)	°C
	Indoor pipe temperature / Cond./ Eva. (TH5 (3)) Indoor 3 -39~88	-39~88 (When the temperature is 0°C or less, “-” and temperature are displayed by turns.) When there is no indoor unit, “00” is displayed.	°C
	Replacement operation ※If replacement operation is conducted even once, “1” is displayed. If replacement operation time is less than 2 hrs. “0” is displayed.	1: Conducted. 0: Not yet.	-

10-9. SELECTING FUNCTIONS USING THE REMOTE CONTROLLER

Each function can be set according to necessity using the remote controller. The setting of function for each unit can only be done by the remote controller. Select function available from the table 1.

<Table 1> Function selections

(1) Functions available when setting the unit number to 00 (Select 00 referring to ④ setting the indoor unit number on P62.)

※1 The functions below are available only when the wired remote controller is used. The functions are not available for floor standing models.

Function	Settings	Mode No.	Setting No.	Initial setting (when sent from the factory)	Remarks
Power failure automatic recovery	OFF	01	1	●	The setting is applied to all the units in the same refrigerant system.
	ON		2		
Indoor temperature detecting	Operating indoor units (The average is considered as indoor temperature.)	02	1	●	
	Indoor unit with remote controller		2		
	Remote controller's internal sensor		3		
LOSSNAY connectivity	Not supported	03	1	●	
	Supported (indoor unit not equipped with outdoor air intake)		2		
	Supported (indoor unit equipped with outdoor air intake)		3		
Power supply voltage	240V	04	1		
	220V,230V		2	●	
Auto operating mode	Auto energy-saving operation ON	05	1	●	
	Auto energy-saving operation OFF		2		
Frost prevention temperature	2°C (Normal)	15	1	●	
	3°C		2		
Humidifier control	When the compressor operates, the humidifier also operates.	16	1	●	
	When the fan operates, the humidifier also operates.		2		
Change of defrosting control	Standard	17	1	●	
	For high humidity		2		

(2) Functions available when setting the unit number to 01-03 or AL (07 in case of wireless remote controller)

- When setting functions for an indoor unit in an independent system, set the unit number to 01 referring to ④ setting the indoor unit number on P62.
- When setting functions for a simultaneous- Twin Triple indoor unit system, set the unit number to 01 to 03 for each indoor unit in case of selecting different functions for each unit referring to ④ setting the indoor unit number on P62.
- When setting the same functions for an entire simultaneous Twin Triple-indoor unit system, set refrigerant address to AL (07 in case of wireless remote controller) referring to ④ setting the indoor unit number on P62.

Function	Settings	Mode No.	Setting No.	Initial setting (when sent from the factory)		Remarks
				4-way cassette PLA-AA (power-cassette)	Ceiling concealed PEAD-EA	
Filter sign	100Hr	07	1			
	2500Hr		2	●		
	No filter sign indicator		3		●	
Fan speed	standard	08	1	●	—	
	High ceiling ①		2		—	
	High ceiling ②		3		—	
No. of air outlets	4 directions	09	1	●	—	
	3 directions		2		—	
	2 directions		3		—	
Installed options (high-performance filter)	Not supported	10	1	●	—	
	Supported		2		—	
Horizontal vane setting	No vanes	11	1		—	
	Equipped with vane (No.1 setting)		2	●	—	
	Equipped with vane (No.2 setting)		3		—	
Energy saving air flow (Heating mode)	Disabled	12	1	●	—	
	Enabled		2		—	
Direct add-on type humidifier (Only for power-cassette)	Not supported	13	1	●	—	
	supported		2		—	
Swing	Not available	23	1		—	
	Available		2	●	—	
Set temperature in heating mode 4deg-up	Available	24	1	●	●	
	Not available		2			
Fan speed when the heating thermostat is OFF	Extra low	25	3	●		
	Low (4-speed model) Low (2-speed model)		1		●	
	Set fan speed		2			
Quiet operation mode of power cassette	Normal	26	1	●	—	
	Quiet		2		—	
Fan speed when the cooling thermostat is OFF	Set fan speed	27	1	●	●	
	Stop		2			
Detection of abnormality of the pipe temperature (P8)	Available	28	1	●	●	
	Not available		2			

10-9-1. Selecting functions using the wired remote controller

[Flow of function selection procedure]

The flow of function selection procedure is shown below. The flow is described in case of setting indoor temperature detecting shown in table 1 on the preceding page. Refer to procedure ① to ⑩ when actually setting functions.

Selecting functions using the wired remote controller

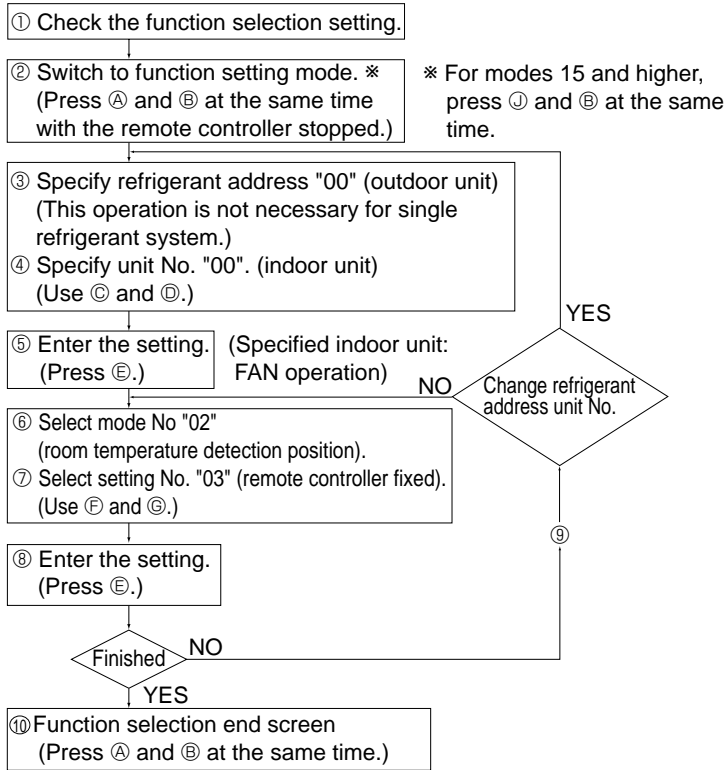

Wired type

- ① Mode number
- ② Setting number
- ③ Refrigerant address
- ④ Unit number

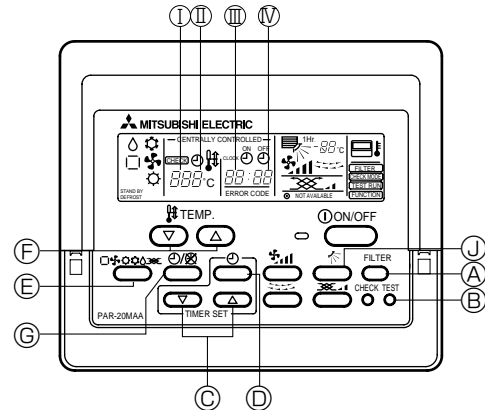

For mode 01 to 13, press A and B at the same time and for mode 15 to 28, press B and J to go to function select mode.

[Operating instructions]

① Checking the function settings

If you change the setting in the function setting procedure, the contents of setting will be changed for the designated mode. Change the setting after recording all the previous setting into the checklist of table 1 by following steps ② to ⑦. In addition, read the installation manual packed with indoor units to be informed of initial setting.

② Turning off the remote controller

Press the **A** FILTER and **B** TEST RUN buttons simultaneously and hold them for at least 2 seconds. (For modes 15 and higher, press **J** and **B** simultaneously for at least 2 seconds.) FUNCTION will start to flash. After a while, the refrigerant address display will start to flash.

③ Setting the refrigerant address No. of outdoor unit

Press **C** **▲** **▼** TIMER SET button to select the refrigerant address from No.00 to No.15. (Set the refrigerant address to No.00 in case of single refrigerant grouping system.)

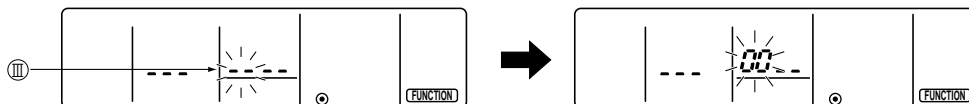

* If the unit stops two seconds after the FUNCTION display starts to flash or [88] starts to flash in the room temperature display, a transmission problem may have occurred. Check to see if there are some sources of transmission interference (noise) nearby.

If you make a mistake during any points of this procedure, you can quit the function setting by pressing ⑩ then return to step ②.

④Setting the indoor unit number

Press Ⓞ(CLOCK ON OFF) and [-] will start to flash in the unit number display (IV) .

Press Ⓞ (▲ ▼) (TIMER SET) button to select the unit number from 00, 01, 02, 03, 04, and AL.

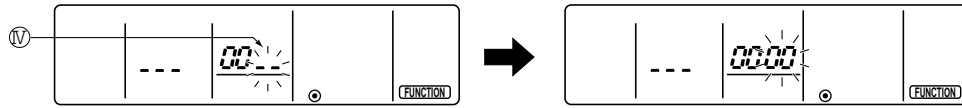

- Set the unit number to 00 if the mode such as power failure automatic recovery, indoor temperature detecting or LOSSNAY connectivity is desired to be selected.
- Select the unit number from 01 to 04 if the function setting is desired to be done for each of them individually.
- Set the unit number to AL if the function setting is desired to be done for all of units simultaneously.

⑤Confirming the refrigerant address and indoor unit number

Press Ⓞ MODE button to confirm the refrigerant address and unit number.

After a while, [-] will flash in the mode number display (I).

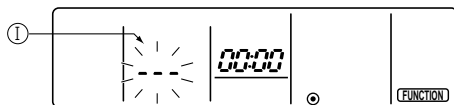

※If [88] appears in the room temperature display section, the selected refrigerant address does not exist in the system. Also, if [F] appears in the unit number display section, the selected unit number does not exist. Enter the correct refrigerant address and unit number at steps ② and ③.

Designated indoor unit starts fan draft operation by pressing Ⓞ MODE button. Check which indoor unit is designated for function setting by doing this. In addition, all the units of the selected refrigerant address start fan draft operation if the unit number is set to 00 or AL.

Example) When the refrigerant address is set to 00 and the unit number is 02;

Ⓞ 00 refrigerant address

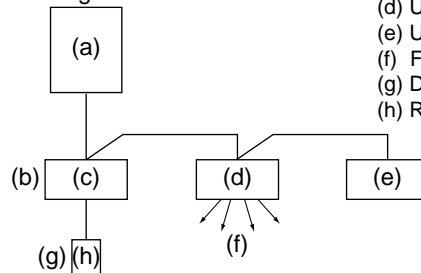

※If any undesigned indoor units start fan draft operation under multiple refrigerant grouping system, refrigerant addresses may be overlapped. Reassign refrigerant addresses at the DIP switch of the outdoor unit.

⑥Selecting the mode number

Press Ⓞ (▲ ▼) (TEMP) buttons to set the desired mode number. (Impossible to set the mode number which is not selectable.)

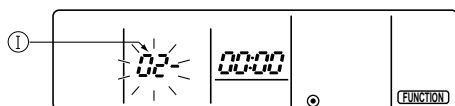

⑦Selecting the setting of designated mode

Press Ⓞ button, and the setting number will start to flash. Check the current status of the setting by doing this.

Press Ⓞ (▲ ▼) (TEMP) button to select the setting number.

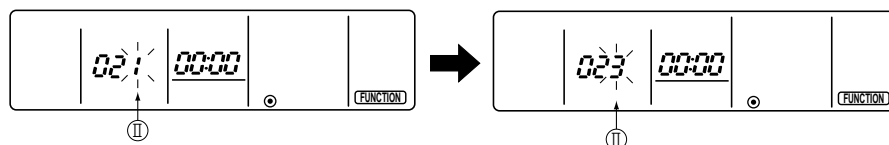

⑧ Registering the settings from steps ④ to ⑦ into memory

The mode and setting numbers (I)(II) will start to flash when the MODE button ⑤ is pressed and registration will begin. The numbers are set when the flashing stays lit.

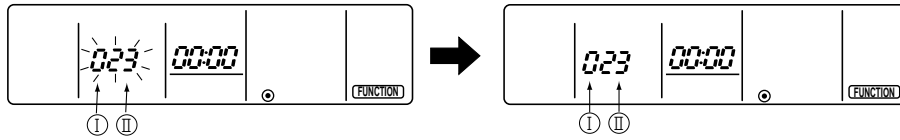

*If [---] appears in the room temperature display as the mode/setting number, or if a flashing [88] display appears, a transmission problem may have occurred. Check to see if there are some sources of transmission interference (noise) nearby.

⑨ Registering other settings simultaneously

Repeat steps ④ to ⑧ to make other function settings.

⑩ Completing the function settings

Press ④ FILTER and ⑥ TEST RUN buttons simultaneously for at least two seconds. (For modes 15 and higher, press ④ and ⑥ simultaneously for at least 2 seconds.) After a while, the function selection screen will disappear and air conditioner OFF display will appear.

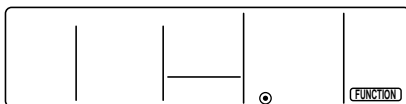

*Do not use the remote controller for 30 seconds after completing the function setting. (Any requests will be rejected.)

Note

Make sure to check all settings with ○ and etc. on the checklist of table 1 if you have changed the settings of indoor units by this procedure after installation construction.

10-9-2. Selecting functions using the wireless remote controller (Type C)

Functions can be selected with the wireless remote controller. Function selection using wireless remote controller is available only for refrigerant system with wireless function. Refrigerant address cannot be specified by the wireless remote controller.

[Flow of function selection procedure]

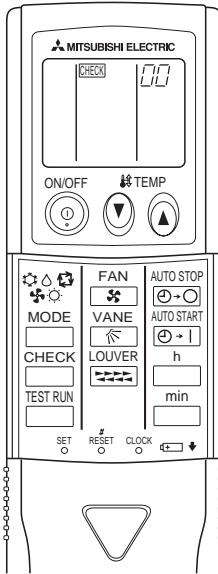

The flow of the function selection procedure is shown below. This example shows how to turn off the function that raises the set temperature by 4 degrees during HEAT operation .
The procedure is given after the flow chart.

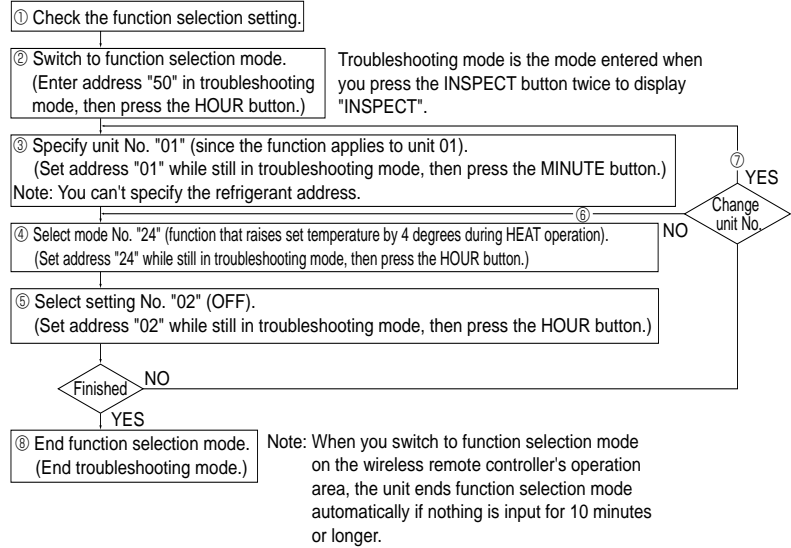

[Operating instructions]

- ① Check the function settings.
 - ② Press the button twice continuously. → is lit and "00" blinks.
Press the temp button once to set "50". Direct the wireless remote controller toward the receiver of the indoor unit and press the button.
 - ③ Set the unit number.
Press the temp button to set the unit number. (Press "01" to specify the indoor unit whose unit number is 01.)
Direct the wireless remote controller toward the receiver of the indoor unit and press the button.
(By setting unit number with the button, specified indoor unit starts performing fan operation.
Detect which unit is assigned to which number using this function. If unit number is set to AL, all the indoor units in same refrigerant system start performing fan operation simultaneously.)
* If a unit number that cannot be recognized by the unit is entered, 3 beeps of 0.4 seconds will be heard. Reenter the unit number setting.
* If the signal was not received by the sensor, you will not hear a beep or a "double beep" may be heard. Reenter the unit number setting.
 - ④ Select a mode.
Press the temp button to set a mode. Press "24" to turn on the function that raises the set temperature by 4 degree during heat operation. Direct the wireless remote controller toward the sensor of the indoor unit and press the button.
→ The sensor-operation indicator will flash and beeps will be heard to indicate the current setting number.
Current setting number: 1 = 1 beep (one second)
2 = 2 beeps (one second each)
3 = 3 beeps (one second each)
* If a mode number that cannot be recognized by the unit is entered, 3 beeps of 0.4 seconds will be heard. Reenter the mode number.
* If the signal was not received by the sensor, you will not hear a beep or a "double beep" may be heard. Reenter the mode number.
 - ⑤ Select the setting number.
Press the temp button to select the setting number. (02: Not available)
Direct the wireless remote controller toward the receiver of the indoor unit and press the button.
→ The sensor-operation indicator will flash and beeps will be heard to indicate the the setting number.
Setting number: 1 = 2 beeps (0.4 seconds each)
2 = 2 beeps (0.4 seconds each, repeated twice)
3 = 2 beeps (0.4 seconds each, repeated three times)
* If a setting number that cannot be recognized by the unit is entered, the setting will turn back to the original setting.
* If the signal was not received by the sensor, you will not hear a beep or a "double beep" may be heard. Reenter the setting number.
 - ⑥ Repeat steps ④ and ⑤ to make an additional setting without changing unit number.
 - ⑦ Repeat steps ③ to ⑤ to change unit number and make function settings on it.
 - ⑧ Complete the function settings
Press button.
- * Do not use the wireless remote controller for 30 seconds after completing the function setting.

PUHZ-RP3VHA

OPERATING PROCEDURE	PHOTOS & ILLUSTRATION
<p>1. Removing the service panel and top panel</p> <p>(1) Remove 3 service panel fixing screws (5 X 10) and slide the hook on the right downward to remove the service panel.</p> <p>(2) Remove screws (3 for front, 3 for rear/5 X 10) of the top panel and remove it.</p>	<p>Figure 1</p>
<p>2. Removing the fan motor (MF1)</p> <p>(1) Remove the service panel. (See figure 1.)</p> <p>(2) Remove the top panel. (See figure 1.)</p> <p>(3) Remove 5 grille fixing screws (5 X 10) to detach the grille. (See figure 1.)</p> <p>(4) Remove a nut (for right handed screw of M6) to detach the propeller fan. (See photo 1.)</p> <p>(5) Disconnect the connectors, FAN11 and FAN12, on controller board in electrical parts box.</p> <p>(6) Remove 4 fan motor fixing screws (5 X 25) to detach the fan motor. (See photo 2.)</p>	<p>Photo 1</p> <p>Photo 2</p>
<p>3. Removing the electrical parts box</p> <p>(1) Remove the service panel. (See figure 1.)</p> <p>(2) Remove the top panel. (See figure 1.)</p> <p>(3) Disconnect the indoor/outdoor connecting wire from terminal block.</p> <p>(4) Remove all the following connectors from controller board; fan motor, linear expansion valve, outdoor pipe temperature thermistor, discharge temperature thermistor, condenser/evaporator temperature thermistor, outside temperature thermistor, radiator panel temperature thermistor, high pressure switch, 4-way valve, and bypass valve. Then remove a screw (4 X 8) from the valve bad to remove the lead wire. Pull out the disconnected wire from the electrical parts box.</p> <p><Diagram symbol in the connector housing></p> <p>Fan motor (FAN11 and FAN12) • Linear expansion valve (LEV-A and LEV-B) • Outdoor pipe temperature thermistor (TH3) • Discharge temperature thermistor (TH4) • Condenser/evaporator temperature thermistor, Outside temperature thermistor (TH6/7) • Radiator panel temperature thermistor (CN3) • High pressure switch (63H) • 4-way valve (21S4) • Bypass valve (SV2)</p> <p>(5) Remove the terminal cover and disconnect the compressor or lead wire.</p> <p>(6) Remove an electrical parts box fixing screw (4 X 10) and detach the electrical parts box by pulling it upward. The electrical parts box is fixed with 2 hooks on the left and 1 hook on the right.</p>	<p>Photo 3</p>



OPERATING PROCEDURE

4. Removing the condenser/evaporator temperature thermistor (TH6)

- (1) Remove the service panel. (See figure 1.)
- (2) Remove the top panel. (See figure 1.)
- (3) Disconnect the connectors, TH6 and TH7 (red), on the controller board in the electrical parts box.
- (4) Loosen the clamp for the lead wire in the rear of the electrical parts box.
- (5) Pull out the condenser/evaporator temperature thermistor (TH6) from the sensor holder.

Note: In case of replacing condenser/evaporator temperature thermistor (TH6), replace it together with outside temperature thermistor (TH7) since they are combined together. Refer to No.5 below to remove outside temperature thermistor.

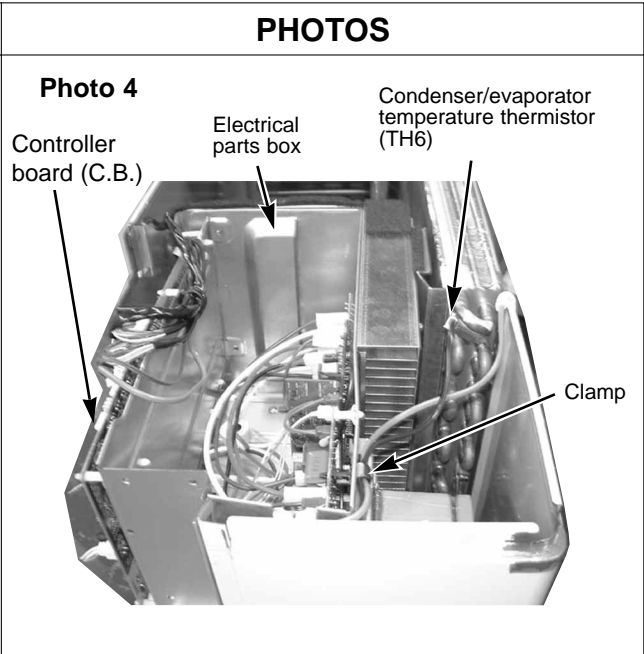

5. Removing outside temperature thermistor (TH7)

- (1) Remove the service panel. (See figure 1.)
- (2) Remove the top panel. (See figure 1.)
- (3) Disconnect the connector TH7 (red) on the controller board in the electrical parts box.
- (4) Loosen the clamp for the lead wire in the rear of the electrical parts box. (See photo 4.)
- (5) Pull out the outside temperature thermistor (TH7) from the sensor holder.

Note: In case of replacing outside temperature thermistor (TH7), replace it together with condenser/evaporator temperature thermistor (TH6), since they are combined together. Refer to No.4 above to remove condenser/evaporator temperature thermistor.

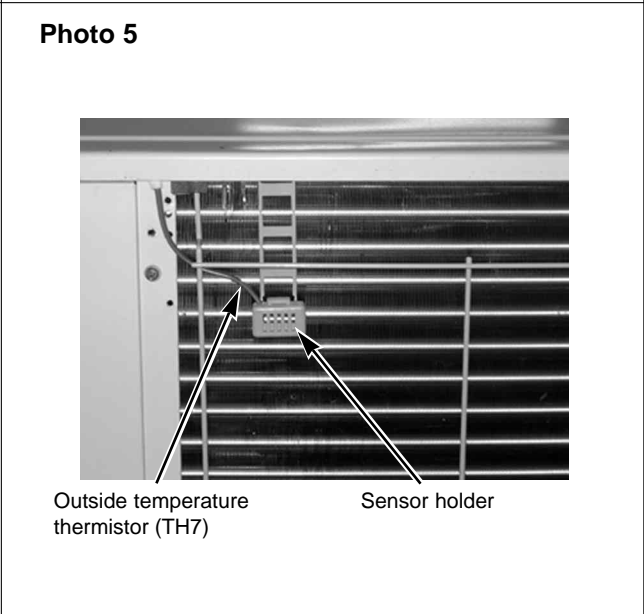

6. Removing outdoor pipe temperature thermistor (TH3) and discharge temperature thermistor (TH4)

- (1) Remove the service panel. (See figure 1.)
- (2) Disconnect the connectors, TH3 (white) and TH4 (white), on the controller board in the electrical parts box.
- (3) Loosen the clamp for the lead wire in the rear of the electrical parts box. (See photo 4.)
- (4) Pull out the outdoor pipe temperature thermistor (TH3) and discharge temperature thermistor (TH4) from the sensor holder.

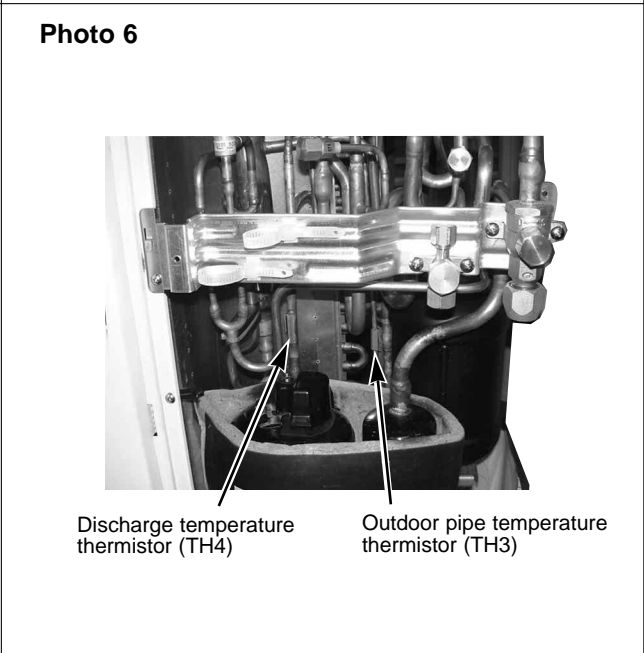

OPERATING PROCEDURE

7. Removing the 4-way valve solenoid coil (21S4), linear expansion valve coil (LEV(A), LEV(B)) and bypass valve solenoid coil (SV)

- (1) Remove the service panel. (See figure 1.)
- (2) Remove the top panel. (See figure 1.)
- (3) Remove the electrical parts box. (See photo 3.)
- <Removing the 4-way valve solenoid coil>
- (4) Remove 4-way valve solenoid coil fixing screw (M4 X 6).
- (5) Remove the 4-way valve solenoid coil by sliding the coil toward you.
- (6) Disconnect the connector 21S4 (green) on the controller board in the electrical parts box.
- <Removing the linear expansion valve coil>
- (4) Remove the linear expansion valve coil by sliding the coil upward.
- (5) Disconnect the connectors, LEV A (white) and LEV B (red), on the controller board in the electrical parts box.
- <Removing the bypass valve solenoid coil>
- (4) Remove the bypass valve solenoid coil fixing screw (M4 X 6).
- (5) Remove the bypass valve solenoid coil by sliding the coil upward.
- (6) Disconnect the connector SV2 (blue) on the controller board in the electrical parts box.

8. Removing the 4-way valve

- (1) Remove the service panel. (See figure 1.)
 - (2) Remove the top panel. (See figure 1.)
 - (3) Remove the electrical parts box. (See photo 3.)
 - (4) Remove 3 valve bed fixing screws (4 X 10) and 4 ball valve and stop valve fixing screws (5 X 16) and then remove the valve bed.
 - (5) Remove 3 right side panel fixing screw (5 X 10) in the rear of the unit and then remove the right side panel.
 - (6) Remove the 4-way valve solenoid coil. (See photo 7.)
 - (7) Collect the refrigerant.
 - (8) Remove the welded part of 4-way valve.
- Note 1: Collect refrigerant without spreading it in the air.
- Note 2: The welded part can be removed easily by removing the right side panel.
- Note 3: When installing the 4-way valve, cover it with a wet cloth to prevent it from heating (120°C or more), then braze the pipes so that the inside of pipes are not oxidized.

9. Removing linear expansion valve

- (1) Remove the service panel. (See figure 1.)
 - (2) Remove the top panel. (See figure 1.)
 - (3) Remove the electrical parts box. (See photo 3.)
 - (4) Remove 3 valve bed fixing screws (4 X 10) and 4 ball valve and stop valve fixing screws (5 X 16) and then remove the valve bed.
 - (5) Remove 3 right side panel fixing screw (5 X 10) in the rear of the unit and then remove the right side panel.
 - (6) Remove the linear expansion valve. (See photo 7.)
 - (7) Collect the refrigerant.
 - (8) Remove the welded part of linear expansion valve.
- Note 1: Collect refrigerant without spreading it in the air.
- Note 2: The welded part can be removed easily by removing the right side panel.
- Note 3: When installing the linear expansion valve, cover it with a wet cloth to prevent it from heating (120°C or more), then braze the pipes so that the inside of pipes are not oxidized.

PHOTOS

Photo 7

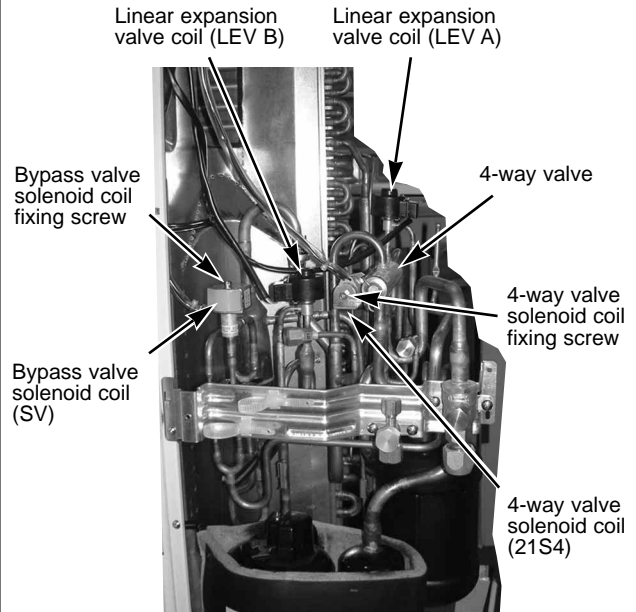
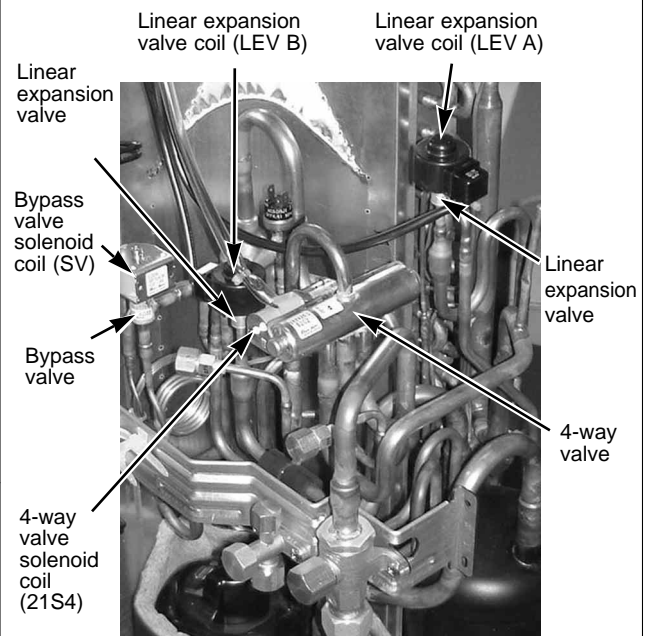

Photo 8





OPERATING PROCEDURE

PHOTOS

10. Removing bypass valve

- (1) Remove the service panel. (See figure 1.)
- (2) Remove the top panel. (See figure 1.)
- (3) Remove the electrical parts box. (See photo 3.)
- (4) Remove 3 right side panel fixing screws (5 X 10) in the rear of the unit and remove the right side panel.
- (5) Remove the bypass valve solenoid coil. (See photo 7.).
- (6) Collect the refrigerant.
- (7) Remove the welded part of bypass valve.

Note 1: Collect refrigerant without spreading it in the air.
 Note 2: The welded part can be removed easily by removing the right side panel.

Photo 9

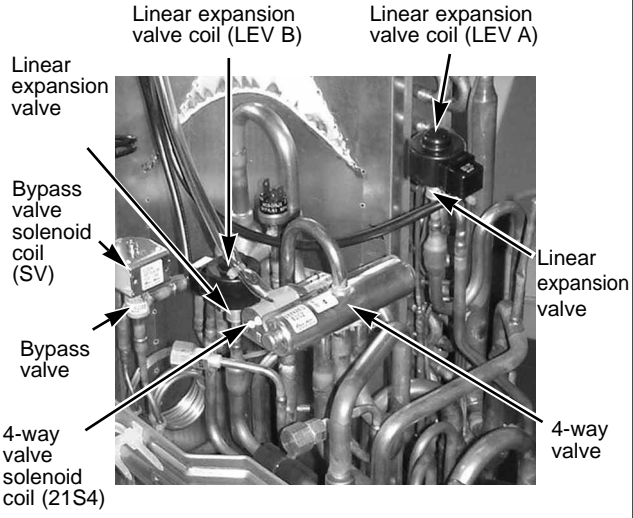

11. Removing the high pressure switch (63H)

- (1) Remove the service panel. (See figure 1.)
- (2) Remove the top panel. (See figure 1.)
- (3) Remove the electrical parts box. (See photo 3.)
- (4) Remove 3 right side panel fixing screws (5 X 10) in the rear of the unit and remove the right side panel.
- (5) Pull out the lead wire of high pressure switch.
- (6) Collect the refrigerant.
- (7) Remove the welded part of high pressure switch.

Note 1: Collect refrigerant without spreading it in the air.
 Note 2: The welded part can be removed easily by removing the right side panel.
 Note 3: When installing the high pressure switch, cover it with a wet cloth to prevent it from heating (100°C or more), then braze the pipes so that the inside of pipes are not oxidized.

Photo 10

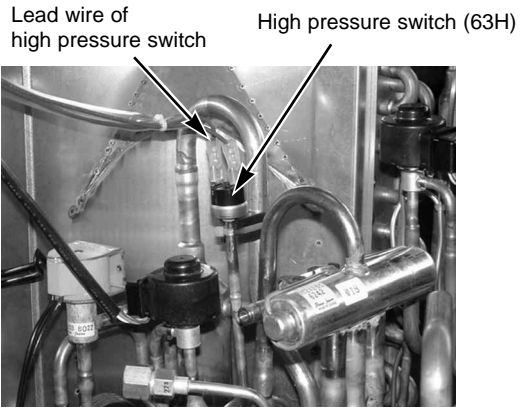

12. Removing the reactor

- (1) Remove the service panel. (See figure 1.)
- (2) Remove the top panel. (See figure 1.)
- (3) Remove the electrical parts box. (See photo 3.)
- (4) Remove 3 reactor fixing screws (4 X 16) and remove the reactor.

※ The reactor is attached to the rear of the electrical parts box.

Photo 11

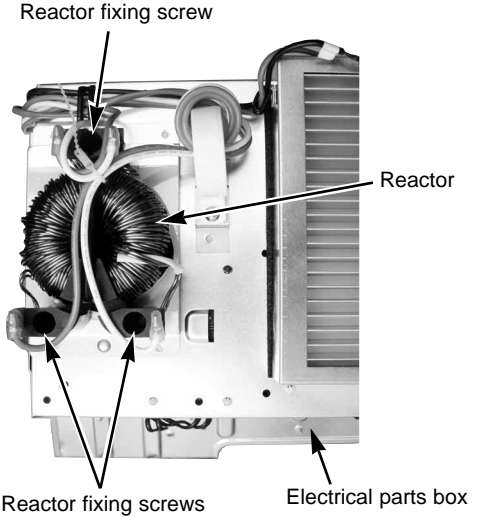

OPERATING PROCEDURE

13. Removing the compressor (MC)

- (1) Remove the service panel. (See figure 1.)
- (2) Remove the top panel. (See figure 1.)
- (3) Remove 2 front cover panel fixing screws (5 X 10) and remove the front cover panel. (See photo 3.)
- (4) Remove 2 back cover panel fixing screws (5 X 10) and remove the back cover panel.
- (5) Remove the electrical parts box. (See photo 3.)
- (6) Remove 3 valve bed fixing screws (4 X 10) and 4 ball valve and stop valve fixing screws (5 X 16) and then remove the valve bed.
- (7) Remove 3 right side panel fixing screw (5 X 10) in the rear of the unit and then remove the right side panel.
- (8) Remove 3 separator fixing screws (4 X 10) and remove the separator.
- (9) Collect the refrigerant.
- (10) Remove the 3 points of the compressor fixing nut using a spanner or a monkey wrench.
- (11) Remove the welded pipe of compressor inlet and outlet and then remove the compressor.

Note: Collect refrigerant without spreading it in the air.

PHOTOS

Photo 12

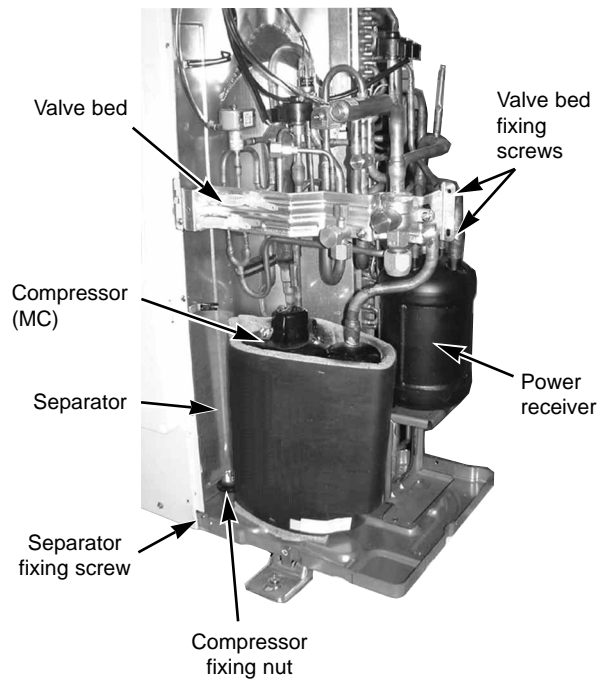

14. Removing the power receiver

- (1) Remove the service panel. (See figure 1.)
- (2) Remove the top panel. (See figure 1.)
- (3) Remove 2 front cover panel fixing screws (5 X 10) and remove the front cover panel. (See photo 3.)
- (4) Remove 2 back cover panel fixing screws (5 X 10) and remove the back cover panel.
- (5) Remove the electrical parts box. (See photo 3.)
- (6) Remove 3 valve bed fixing screws (4 X 10) and 4 ball valve and stop valve fixing screws (5 X 16) and then remove the valve bed.
- (7) Remove 3 right side panel fixing screw (5 X 10) in the rear of the unit and then remove the right side panel.
- (8) Collect the refrigerant.
- (9) Remove 4 welded pipes of power receiver inlet and outlet.
- (10) Remove 2 receiver leg fixing screws (4 X 10).

Note: Collect refrigerant without spreading it in the air.

Photo 13

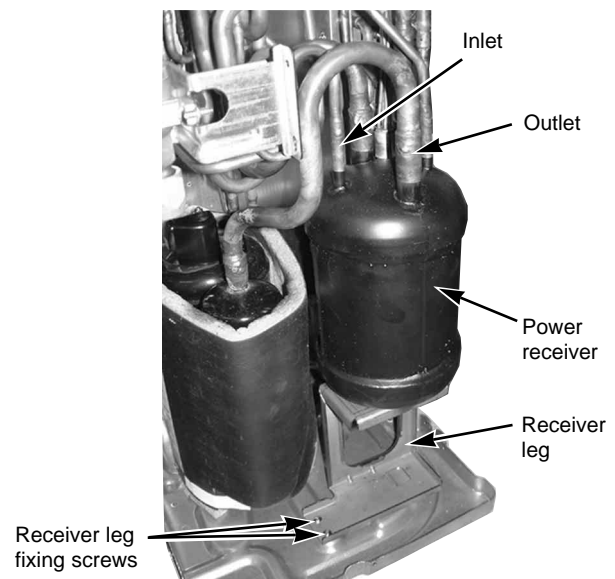

PUHZ-RP4VHA, PUHZ-RP5VHA, PUHZ-RP6VHA

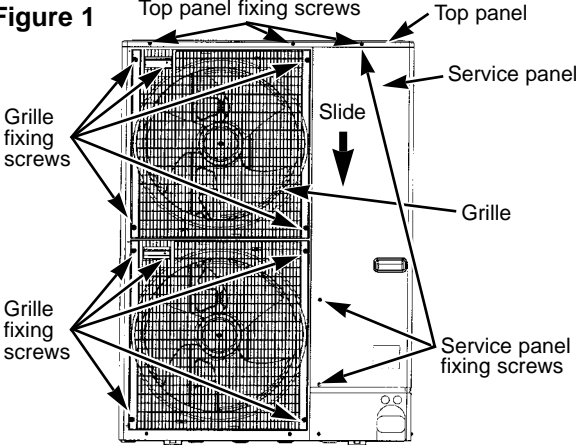
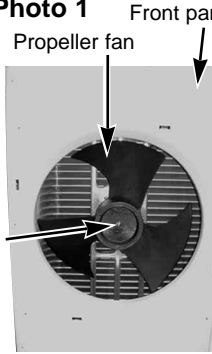
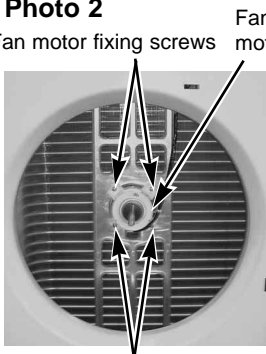
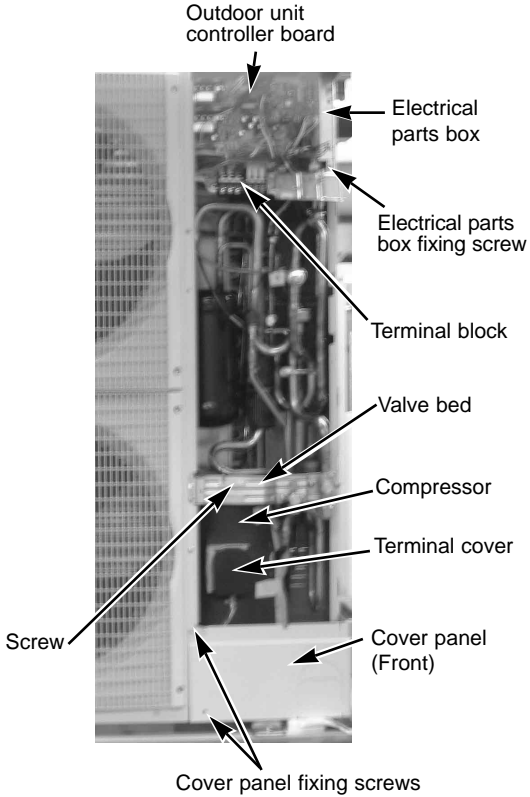
OPERATING PROCEDURE	PHOTOS & ILLUSTRATION
<p>1. Removing the service panel and top panel</p> <p>(1) Remove 3 service panel fixing screws (5 X 10) and slide the hook on the right downward to remove the service panel.</p> <p>(2) Remove screws (3 for front, 3 for rear/5 X 10) of the top panel and remove it.</p>	<p>Figure 1</p> 
<p>2. Removing the fan motor (MF1, MF2)</p> <p>(1) Remove the service panel. (See figure 1.)</p> <p>(2) Remove the top panel. (See figure 1.)</p> <p>(3) Remove 5 grille fixing screws (5 X 10) to detach the grille. (See figure 1.)</p> <p>(4) Remove a nut (for right handed screw of M6) to detach the propeller fan. (See photo 1.)</p> <p>(5) Disconnect the connectors, FAN11, FAN12, FAN21 and FAN 22 on controller board in electrical parts box.</p> <p>(6) Remove 4 fan motor fixing screws (5 X 25) to detach the fan motor. (See photo 2.)</p>	<p>Photo 1</p>  <p>Photo 2</p> 
<p>3. Removing the electrical parts box</p> <p>(1) Remove the service panel. (See figure 1.)</p> <p>(2) Remove the top panel. (See figure 1.)</p> <p>(3) Disconnect the indoor/outdoor connecting wire from terminal block.</p> <p>(4) Remove all the following connectors from controller board; fan motor, linear expansion valve, outdoor pipe temperature thermistor, discharge temperature thermistor, condenser/evaporator temperature thermistor, outside temperature thermistor, radiator panel temperature thermistor, high pressure switch, high pressure switch, 4-way valve, and bypass valve. Then remove a screw (4 X 8) from the valve bad to remove the lead wire. Pull out the disconnected wire from the electrical parts box.</p> <p><Diagram symbol in the connector housing></p> <ul style="list-style-type: none"> • Fan motor (FAN11, FAN12, FAN21 and FAN22) • Linear expansion valve (LEV-A and LEV-B) • Outdoor pipe temperature thermistor (TH3) • Discharge temperature thermistor (TH4) • Condenser/evaporator temperature thermistor, Outside temperature thermistor (TH6/7) • Radiator panel temperature thermistor (CN3) • High pressure switch (63H) • Low pressure switch (63L) • 4-way valve (21S4) • Bypass valve (SV2) <p>(5) Remove the terminal cover and disconnect the compressor lead wire.</p> <p>(6) Remove an electrical parts box fixing screw (4 X 10) and detach the electrical parts box by pulling it upward. The electrical parts box is fixed with 2 hooks on the left and 1 hook on the right.</p>	<p>Photo 3</p> 

OPERATING PROCEDURE

4. Removing the condenser/evaporator temperature thermistor (TH6)

- (1) Remove the service panel. (See figure 1.)
- (2) Remove the top panel. (See figure 1.)
- (3) Disconnect the connectors, TH6 and TH7 (red), on the controller board in the electrical parts box.
- (4) Loosen the clamp for the lead wire in the rear of the electrical parts box.
- (5) Pull out the condenser/evaporator temperature thermistor (TH6) from the sensor holder.

Note: In case of replacing condenser/evaporator temperature thermistor (TH6), replace it together with outside temperature thermistor (TH7) since they are combined together. Refer to No.5 below to remove outside temperature thermistor.

5. Removing outside temperature thermistor (TH7)

- (1) Remove the service panel. (See figure 1.)
- (2) Remove the top panel. (See figure 1.)
- (3) Disconnect the connector TH7 (red) on the controller board in the electrical parts box.
- (4) Loosen the clamp for the lead wire in the rear of the electrical parts box. (See photo 4.)
- (5) Pull out the outside temperature thermistor (TH7) from the sensor holder.

Note: In case of replacing outside temperature thermistor (TH7), replace it together with condenser/evaporator temperature thermistor (TH6), since they are combined together. Refer to No.4 above to remove condenser/evaporator temperature thermistor.

6. Removing outdoor pipe temperature thermistor (TH3) and discharge temperature thermistor (TH4)

- (1) Remove the service panel. (See figure 1.)
- (2) Disconnect the connectors, TH3 (white) and TH4 (white), on the controller board in the electrical parts box.
- (3) Loosen the clamp for the lead wire in the rear of the electrical parts box. (See photo 4.)
- (4) Pull out the outdoor pipe temperature thermistor (TH3) and discharge temperature thermistor (TH4) from the sensor holder.

PHOTOS

Photo 4

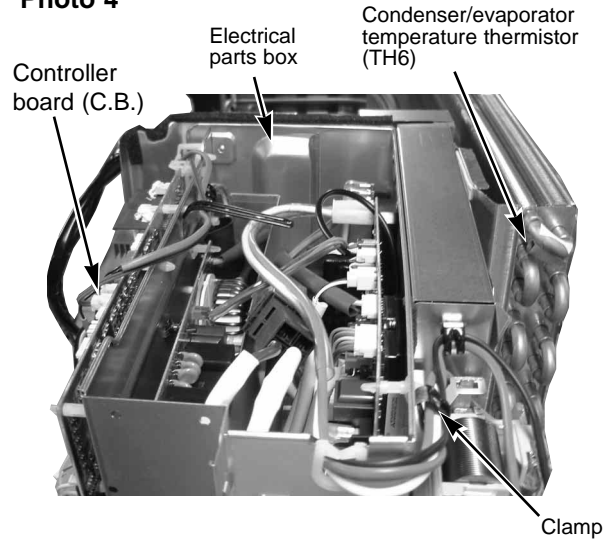

Photo 5

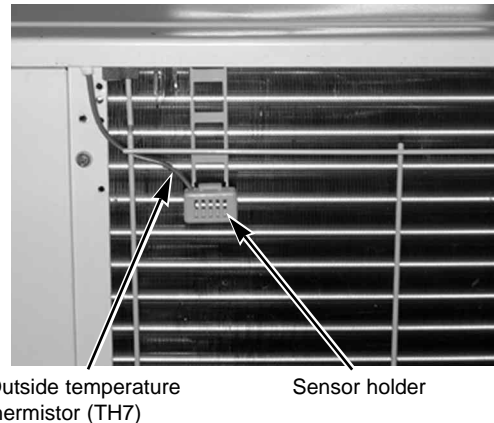
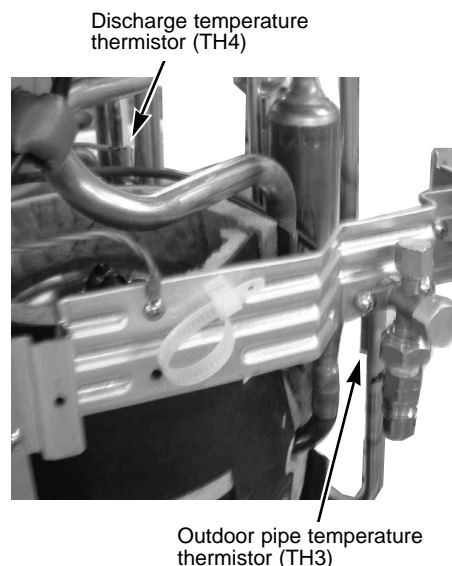

Photo 6



OPERATING PROCEDURE

7. Removing the 4-way valve solenoid coil (21S4) and linear expansion valve coil (LEV(A), LEV(B))

- (1) Remove the service panel. (See figure 1.)
- (2) Remove the top panel. (See figure 1.)
- <Removing the 4-way valve solenoid coil>
- (3) Remove 4-way valve solenoid coil fixing screw (M4 X 6).
- (4) Remove the 4-way valve solenoid coil by sliding the coil toward you.
- (5) Disconnect the connector 21S4 (green) on the controller board in the electrical parts box.
- <Removing the linear expansion valve coil>
- (3) Remove the linear expansion valve coil by sliding the coil upward.
- (4) Disconnect the connectors, LEV A (white) and LEV B (red), on the controller board in the electrical parts box.

8. Removing the 4-way valve

- (1) Remove the service panel. (See figure 1.)
 - (2) Remove the top panel. (See figure 1.)
 - (3) Remove 3 valve bed fixing screws (4 X 10) and 4 ball valve and stop valve fixing screws (5 X 16) and then remove the valve bed.
 - (4) Remove 4 right side panel fixing screw (5 X 10) in the rear of the unit and then remove the right side panel.
 - (5) Remove the 4-way valve solenoid coil. (See photo 7.)
 - (6) Collect the refrigerant.
 - (7) Remove the welded part of 4-way valve.
- Note 1: Collect refrigerant without spreading it in the air.
- Note 2: The welded part can be removed easily by removing the right side panel.
- Note 3: When installing the 4-way valve, cover it with a wet cloth to prevent it from heating (120°C or more), then braze the pipes so that the inside of pipes are not oxidized.

9. Removing linear expansion valve

- (1) Remove the service panel. (See figure 1.)
 - (2) Remove the top panel. (See figure 1.)
 - (3) Remove 3 valve bed fixing screws (4 X 10) and 4 ball valve and stop valve fixing screws (5 X 16) and then remove the valve bed.
 - (4) Remove 4 right side panel fixing screw (5 X 10) in the rear of the unit and then remove the right side panel.
 - (5) Remove the linear expansion valve. (See photo 7.)
 - (6) Collect the refrigerant.
 - (7) Remove the welded part of linear expansion valve.
- Note 1: Collect refrigerant without spreading it in the air.
- Note 2: The welded part can be removed easily by removing the right side panel.
- Note 3: When installing the linear expansion valve, cover it with a wet cloth to prevent it from heating (120°C or more), then braze the pipes so that the inside of pipes are not oxidized.

PHOTOS

Photo 7

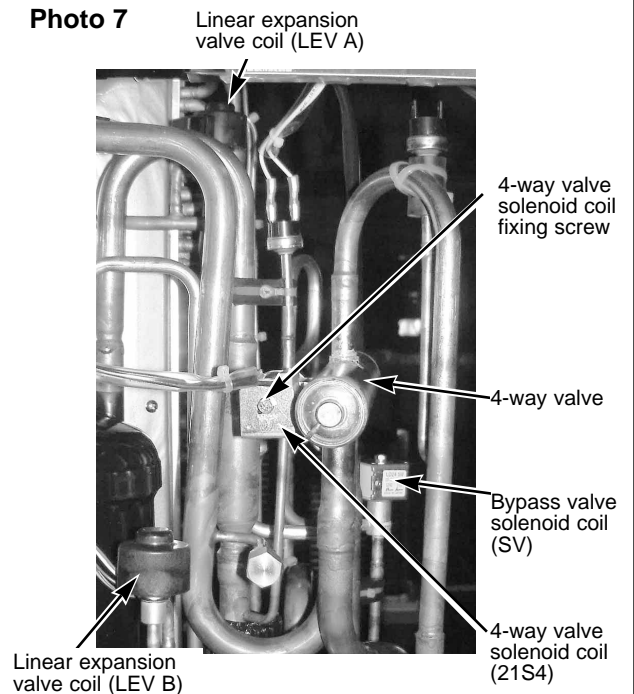
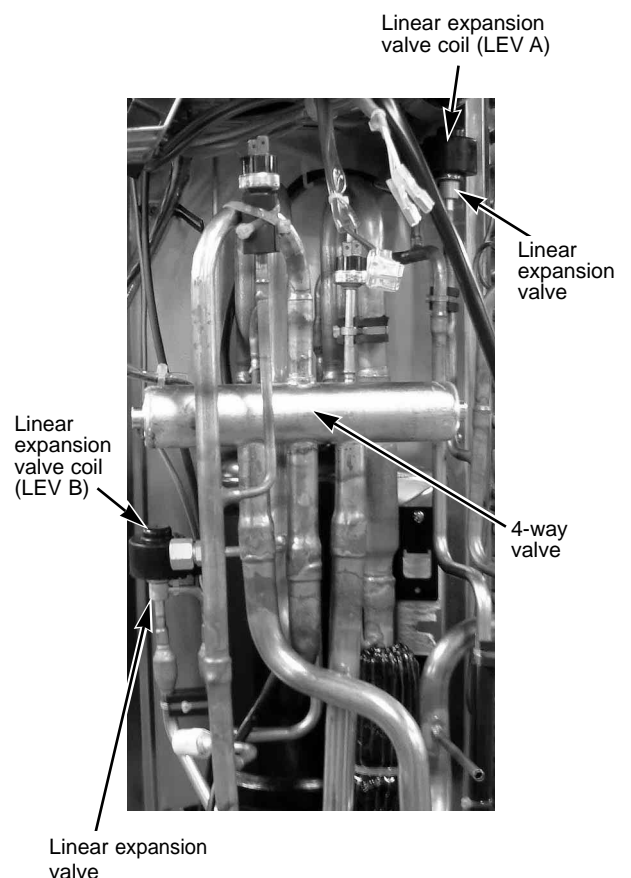

Photo 8



OPERATING PROCEDURE

10. Removing bypass valve solenoid coil (SV) and bypass valve

- (1) Remove the service panel. (See figure 1.)
- (2) Remove the top panel. (See figure 1.)
- (3) Remove 3 right side panel fixing screws (5 X 10) in the rear of the unit and remove the right side panel.
- (4) Remove the bypass valve solenoid coil fixing screw (M4 X 6).
- (5) Remove the bypass valve solenoid coil by sliding the coil upward.
- (6) Disconnect the connector SV2 (blue) on the controller board in the electrical parts box.
- (7) Collect the refrigerant.
- (8) Remove the welded part of bypass valve.

Note 1: Collect refrigerant without spreading it in the air.

Note 2: The welded part can be removed easily by removing the right side panel.

PHOTOS

Photo 9

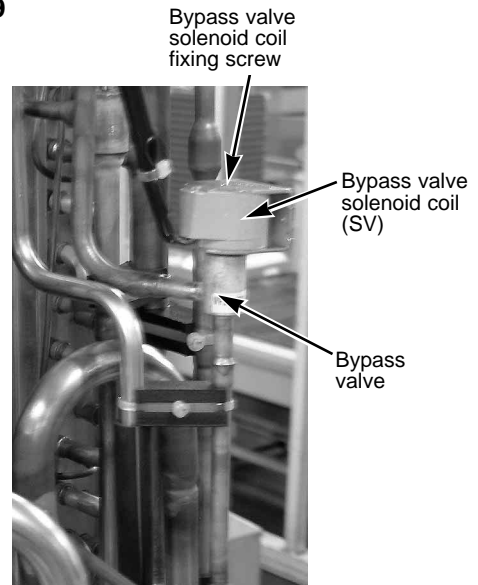

11. Removing the high pressure switch (63H) and low pressure switch (63L)

- (1) Remove the service panel. (See figure 1.)
- (2) Remove the top panel. (See figure 1.)
- (3) Remove 3 right side panel fixing screws (5 X 10) in the rear of the unit and remove the right side panel.
- (4) Pull out the lead wire of high pressure switch and low pressure switch.
- (5) Collect the refrigerant.
- (6) Remove the welded part of high pressure switch and low pressure switch.

Note 1: Collect refrigerant without spreading it in the air.

Note 2: The welded part can be removed easily by removing the right side panel.

Note 3: When installing the high pressure switch, cover it with a wet cloth to prevent it from heating (100°C or more), then braze the pipes so that the inside of pipes are not oxidized.

Photo 10

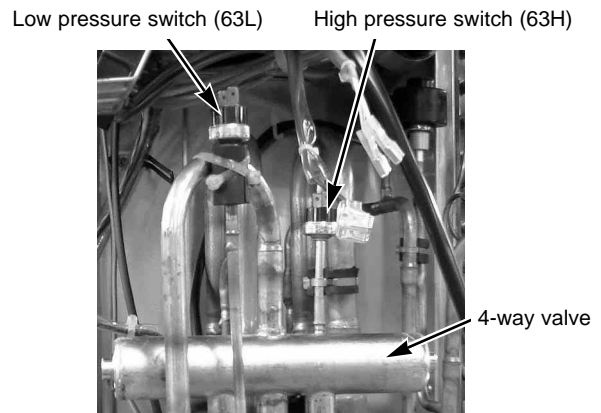

12. Removing the reactor and capacitor (CE)

- (1) Remove the service panel. (See figure 1.)
- (2) Remove the top panel. (See figure 1.)
- (3) Remove the electrical parts box. (See photo 3.)
- <Removing the reactor>
- (4) Remove 8 reactor fixing screws (4 X 10) and remove the reactor.
- <Removing the capacitor>
- (4) Remove 2 capacitor band fixing screws (4 X 10) and remove the capacitor.

* The reactor and capacitor is attached to the rear of the electrical parts box.

Photo 11

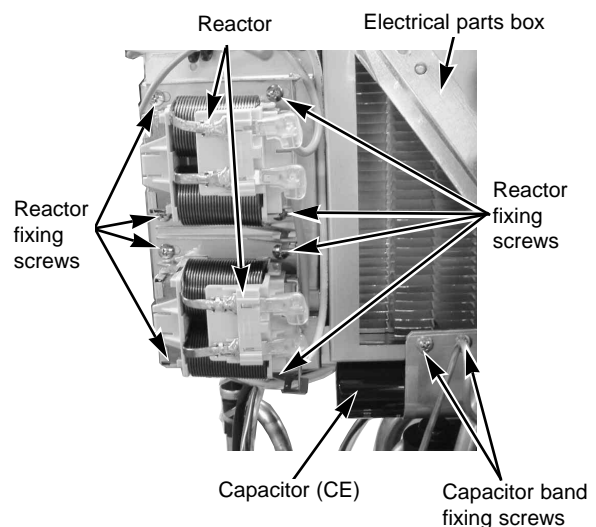

OPERATING PROCEDURE

13. Removing the compressor (MC)

- (1) Remove the service panel. (See figure 1.)
- (2) Remove the top panel. (See figure 1.)
- (3) Remove 2 front cover panel fixing screws (5 X 10) and remove the front cover panel. (See photo 3.)
- (4) Remove 2 back cover panel fixing screws (5 X 10) and remove the back cover panel.
- (5) Remove the electrical parts box. (See photo 3.)
- (6) Remove 3 valve bed fixing screws (4 X 10) and 4 ball valve and stop valve fixing screws (5 X 16) and then remove the valve bed.
- (7) Remove 3 right side panel fixing screw (5 X 10) in the rear of the unit and then remove the right side panel.
- (8) Remove 3 separator fixing screws (4 X 10) and remove the separator.
- (9) Collect the refrigerant.
- (10) Remove the 3 points of the compressor fixing nut using a spanner or a monkey wrench.
- (11) Remove the welded pipe of compressor inlet and outlet and then remove the compressor.

Note: Collect refrigerant without spreading it in the air.

PHOTOS

Photo 12

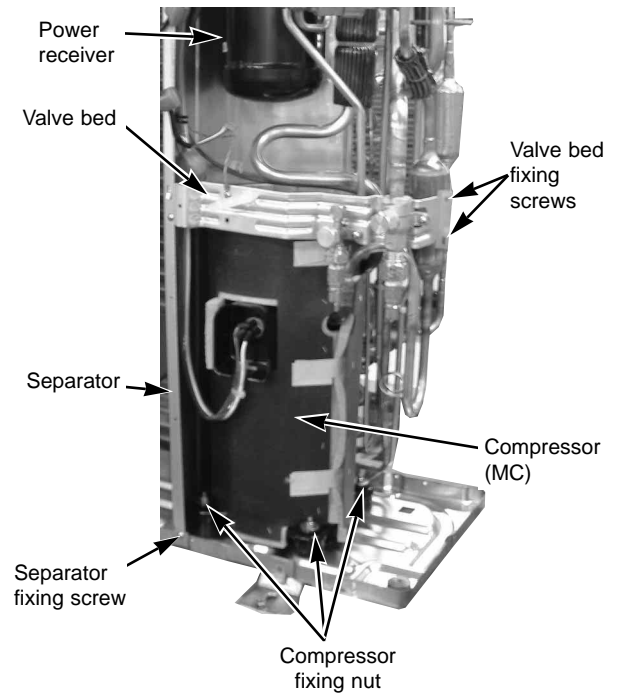

14. Removing the power receiver

- (1) Remove the service panel. (See figure 1.)
- (2) Remove the top panel. (See figure 1.)
- (3) Remove 2 front cover panel fixing screws (5 X 10) and remove the front cover panel. (See photo 3.)
- (4) Remove 2 back cover panel fixing screws (5 X 10) and remove the back cover panel.
- (5) Remove the electrical parts box. (See photo 3.)
- (6) Remove 3 right side panel fixing screw (5 X 10) in the rear of the unit and then remove the right side panel.
- (7) Collect the refrigerant.
- (8) Remove 4 welded pipes of power receiver inlet and outlet.
- (9) Remove 2 receiver leg fixing screws (4 X 10).

Note: Collect refrigerant without spreading it in the air.

Photo 13

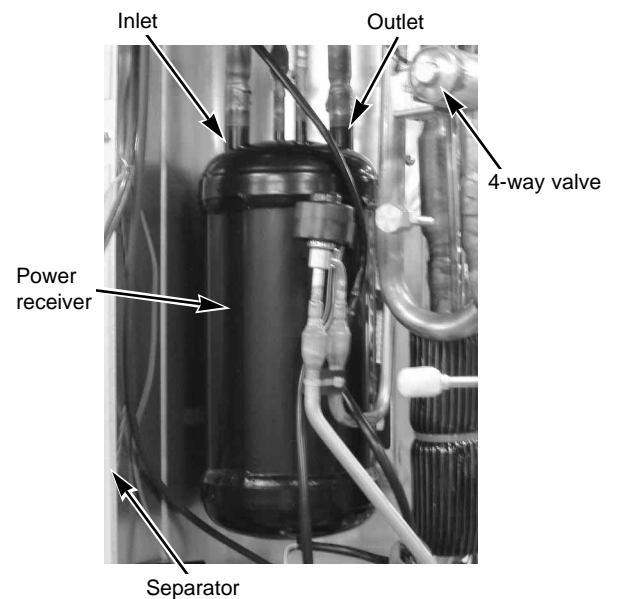

STRUCTURAL PARTS
PUHZ-RP3VHA

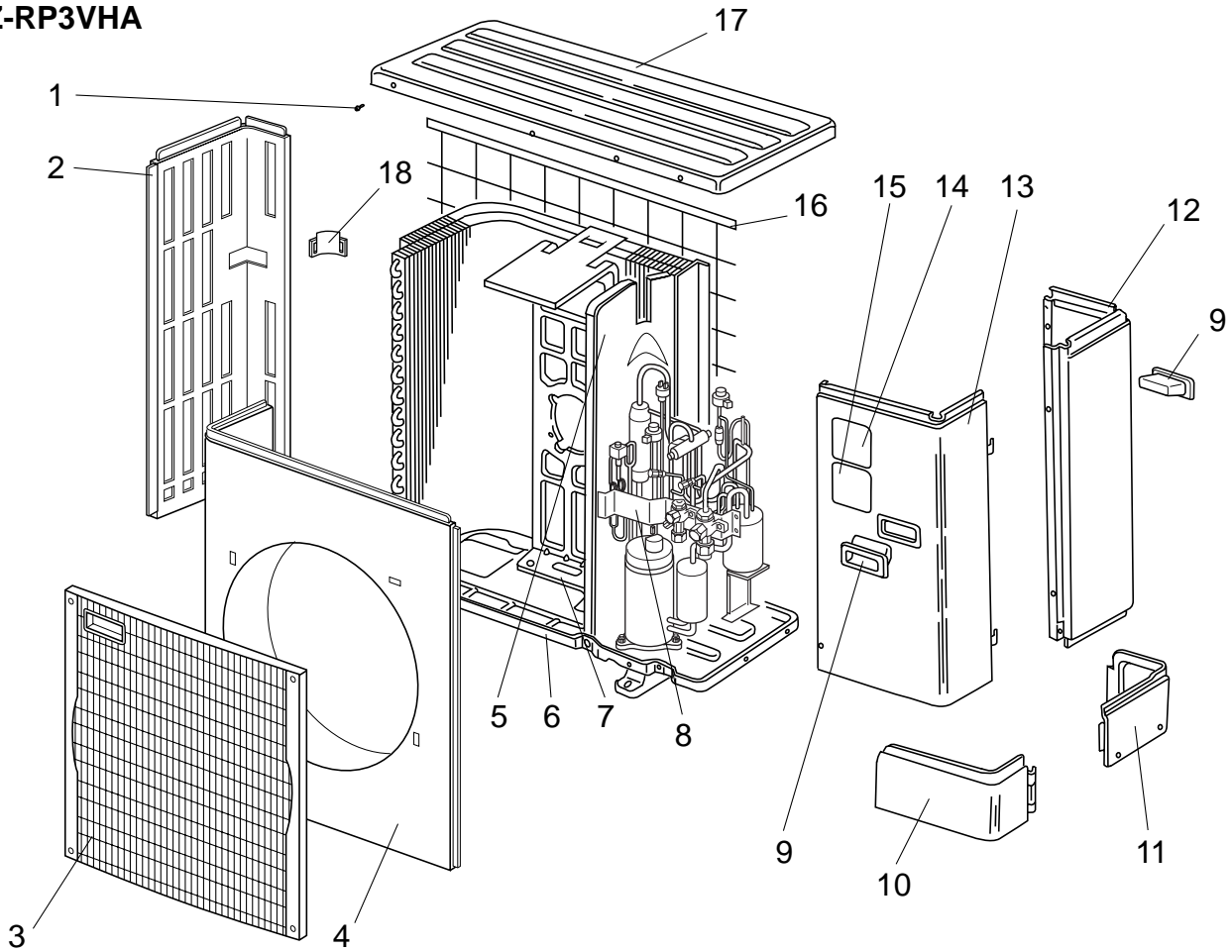

No.	Part No.	Part Name	Specification	Q'ty/set	Remarks (Drawing No.)	Wiring Diagram Symbol	Recom- mended Q'ty	Price	
				PUHZ-RP3VHA				Unit	Amount
1	—	F.ST SCREW	(5X10)	31	(DG12F536H10)				
2	R01 E01 662	SIDE PANEL (L)		1					
3	TEW E02 691	FAN GRILLE		1					
4	T7W E01 667	FRONT PANEL		1					
5	—	SEPARATOR		1	(BK00C143G25)				
6	R01 E13 686	BASE ASSY		1					
7	R01 E06 130	MOTOR SUPPORT		1					
8	—	VALVE BED ASSY		1	(BK00C142G07)				
9	R01 30L 655	HANDEL		2					
10	R01 E02 658	COVER PANEL (FRONT)		1					
11	R01 E01 658	COVER PANEL (REAR)		1					
12	R01 E03 661	SIDE PANEL (R)		1					
13	T7W E02 668	SERVICE PANEL		1					
14	—	LABEL (MITSUBISHI)		1	(DG79R130H01)				
15	—	LABEL (INVERTER)		1	(BK79C208G01)				
16	R01 E00 698	REAR GUARD		1					
17	R01 E04 641	TOP PANEL		1					
18	R01 E00 655	HANDEL		1					

STRUCTURAL PARTS

PUHZ-RP4VHA

PUHZ-RP5VHA

PUHZ-RP6VHA

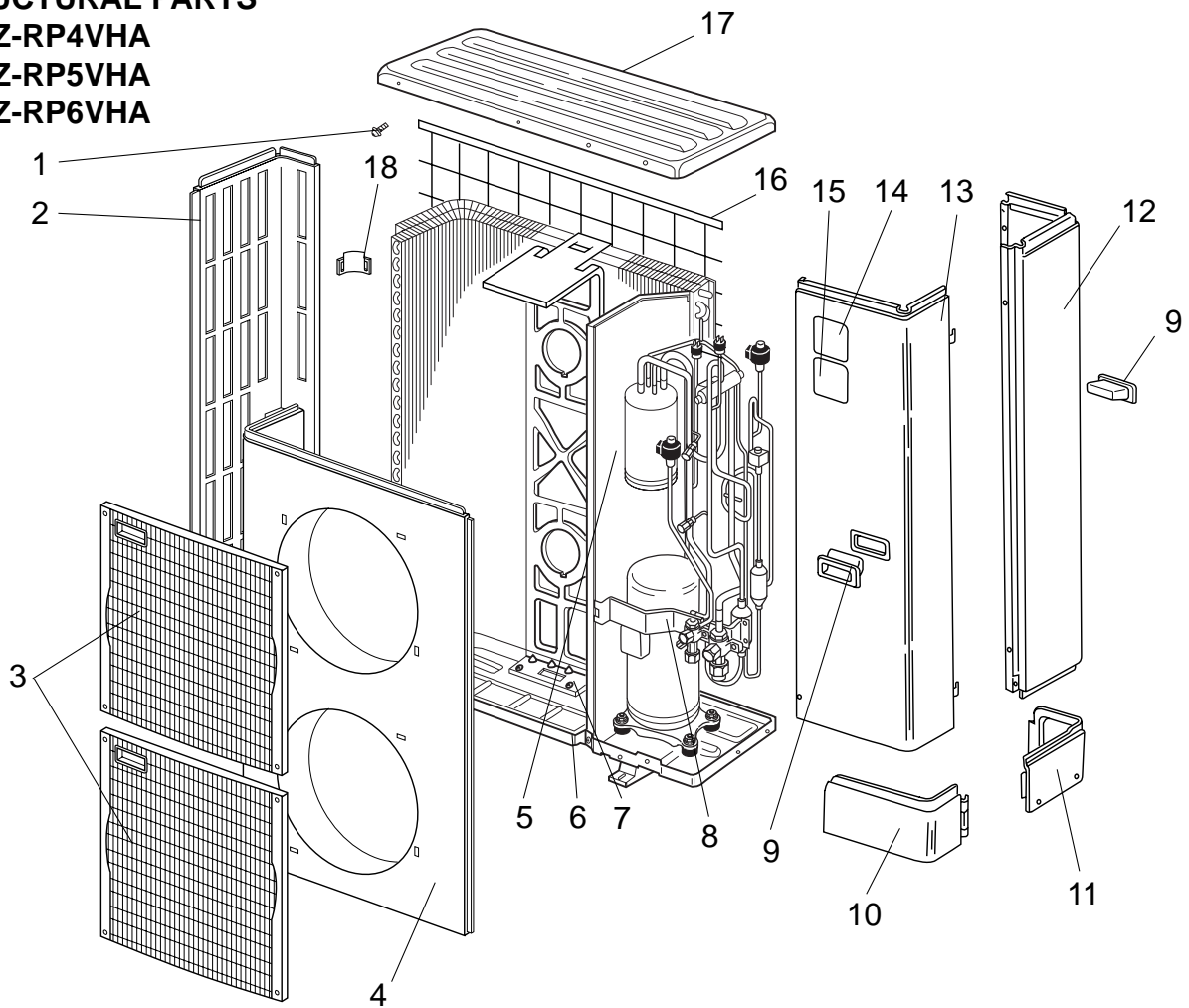

No.	Part No.	Part Name	Specificatio	Q'ty/set			Remarks (Drawing No.)	Wining Diagram Symbol	Recom- mended Q'ty	Price	
				PUHZ-RP						Unit	Amount
				4	5	6					
				VHA							
1	—	F.ST SCREW	(5X10)	38	38	38	(DG12F536H10)				
2	R01 E02 662	SIDE PANEL (L)		1	1	1					
3	T7W E02 691	FAN GRILLE		2	2	2					
4	T7W E02 667	FRONT PANEL		1	1	1					
5	—	SEPARATOR		1	1	1	(BK00C143G27)				
6	R01 E14 686	BASE ASSY		1	1	1					
7	R01 E07 130	MOTOR SUPPORT		1	1	1					
8	—	VALVE BED ASSY		1	1	1	(BK00C142G07)				
9	R01 30L 655	HANDEL		2	2	2					
10	R01 E00 658	COVER PANEL (FRONT)		1	1	1					
11	R01 E01 658	COVER PANEL (REAR)		1	1	1					
12	R01 E04 661	SIDE PANEL (R)		1	1	1					
13	T7W E03 668	SERVICE PANEL		1	1	1					
14	—	LABEL (MITSUBISHI)		1	1	1	(DG79R130H01)				
15	—	LABEL (INVERTER)		1	1	1	(BK79C208G01)				
16	R01 E01 698	REAR GUARD		1	1	1					
17	R01 E04 641	TOP PANEL		1	1	1					
18	R01 E00 655	HANDEL		1	1	1					

FUNCTIONAL PARTS
PUHZ-RP3VHA

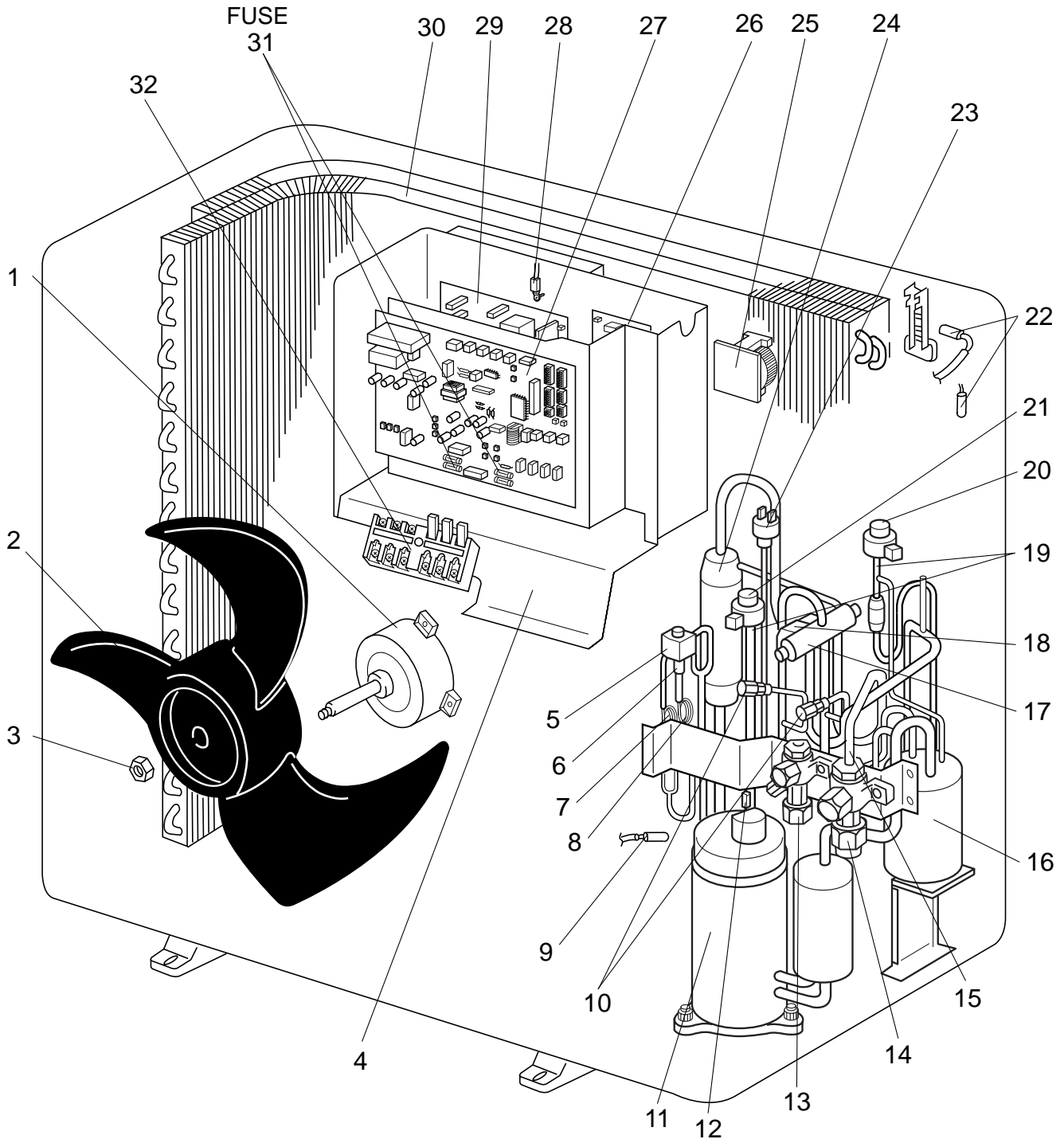



No.	Part No.			Part Name	Specification	Q'ty/set	Remarks (Drawing No.)	Wiring Diagram Symbol	Recom- mended Q'ty	Price	
						PUHZ-RP3VHA				Unit	Amount
1	R01	E28	221	FAN MOTOR		1		MF1			
2	R01	E01	115	PROPELLER FAN		1					
3	R01	E02	097	NUT		1					
4	—			ELECTRICAL PARTS BOX		1	(BK00B055G07)				
5	T7W	E00	242	BYPASS VALVE SOLENOID COIL		1		SV			
6	R01	E03	428	BYPASS VALVE		1					
7	R01	E15	425	CAPILLARY TUBE	$\phi 4.0 \times \phi 2.4 \times 500\text{mm}$	1					
8	R01	E16	425	CAPILLARY TUBE	$\phi 2.5 \times \phi 0.6 \times 1000\text{mm}$	1					
9	R01	17T	201	THERMISTOR (DISCHARGE)		1		TH4			
10	R01	E06	413	CHARGE PLUG		2					
11	T97	410	240	COMPRESSOR	TNB220FMBH Including RUBBER MOUNT	1		MC			
12	R01	E67	202	THERMISTOR (OUTDOOR PIPE)		1		TH3			
13	R01	E05	411	STOP VALVE	3/8	1					
14	R01	E05	410	BALL VALVE	5/8	1					
15	R01	36L	450	STRAINER		1					
16	R01	E13	440	POWER RECEIVER		1					
17	R01	E05	403	4-WAY VALVE		1					
18	T7W	E05	242	4-WAY VALVE SOLENOID COIL COIL		1		21S4			
19	R01	E34	401	EXPANSION VALVE		2					
20	R01	E08	242	LINEAR EXPANSION VALVE COIL		1		LEV(A)			
21	R01	E12	242	LINEAR EXPANSION VALVE COIL		1		LEV(B)			
22	R01	E68	202	THERMISTOR (COND. / EVA. , OUTSIDE)		1		TH6,7			
23	T7W	E01	208	HIGH PRESSURE SWITCH		1		63H			
24	R01	E01	490	OIL SEPARATOR		1					
25	R01	E06	259	REACTOR		1		ACL			
26	T7W	E03	346	NOISE FILTER BOARD		1		N.F.			
27	T7W	E16	315	CONTROLLER BOARD		1		C.B.			
28	R01	E65	202	THERMISTOR (HEAT SINK)		1		TH8			
29	T7W	E06	313	POWER BOARD		1		P.B.			
30	R01	E44	408	HEAT EXCHANGER		1					
31	T7E	520	239	FUSE	250V 6.3A	4		FUSE1,2,3,4			
32	T7W	E16	716	TERMINAL BLOCK	6P(L,N,⊕,S1,S2,S3)	1		TB1			

FUNCTIONAL PARTS
PUHZ-RP4VHA
PUHZ-RP5VHA
PUHZ-RP6VHA

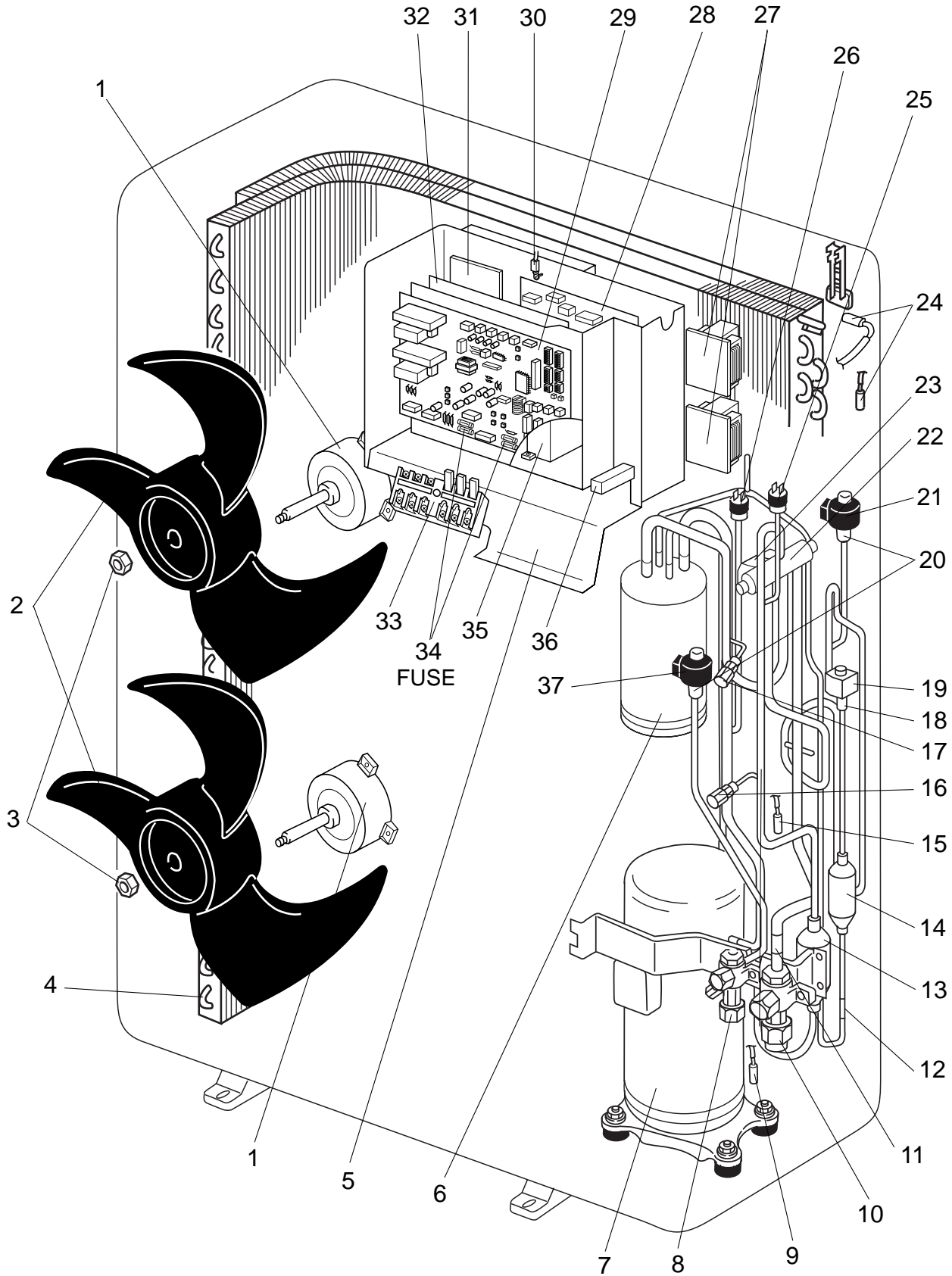

Part numbers that is circled is not shown in the figure.

No.	Part No.	Part Name	Specification	Q'ty/set			Remarks (Drawing No.)	Wiring Diagram Symbol	Recom- mended Q'ty	Price	
				PUHZ-RP						Unit	Amount
				4	5	6					
				VHA							
1	R01 E29 221	FAN MOTOR		2	2	2		MF1,2			
2	R01 E01 115	PROPELLER FAN		2	2	2					
3	R01 E02 097	NUT		2	2	2					
4	R01 E46 408	HEAT EXCHANGER		1	1	1					
5	—	ELECTRICAL PARTS BOX		1	1	1	(BK00B055G08)				
6	R01 E14 440	POWER RECEIVER		1	1	1					
7	T97 410 740	COMPRESSOR	ANV33FDAMT Including RUBBER MOUNT	1	1	1		MC			
8	R01 E05 411	STOP VALVE	3/8	1	1	1					
9	R01 E02 201	THERMISTOR (DISCHARGE)		1	1	1		TH4			
10	R01 E05 410	BALL VALVE	5/8	1	1	1					
11	R01 36L 450	STRAINER		1	1	1					
12	R01 E02 418	RESTRICTOR VALVE		1	1	1					
13	R01 E05 467	MUFFLER		1	1	1					
14	—	REPLACE FILTER		1	1	1	(BK00C119G02)				
15	R01 E66 202	THERMISTOR (OUTDOOR PIPE)		1	1	1		TH3			
16	R01 E06 413	CHARGE PLUG		1	1	1					
17	R01 E08 413	CHARGE PLUG		1	1	1					
18	R01 E03 428	BYPASS VALVE		1	1	1					
19	T7W E00 242	BYPASS VALVE SOLENOID COIL		1	1	1		SV			
20	R01 E33 401	EXPANSION VALVE		2	2	2					
21	T7W E03 242	LINEAR EXPANSION VALVE COIL		1	1	1		LEV(A)			
22	R01 E06 403	4-WAY VALVE		1	1	1					
23	T7W A01 242	4-WAY VALVE SOLENOID COIL		1	1	1		21S4			
24	R01 E68 202	THERMISTOR (COND./EVA., OUTSIDE)		1	1	1		TH6,7			
25	T7W E01 208	HIGH PRESSURE SWITCH		1	1	1		63H			
26	R01 25T 209	LOW PRESSURE SWITCH		1	1	1		63L			
27	T7W E01 259	REACTOR		2	2	2					
28	T7W E07 313	POWER BOARD		1	1	1		P.B.			
29	T7W E16 315	CONTROLLER BOARD		1	1			C.B.			
	T7W E20 315	CONTROLLER BOARD				1		C.B.			
30	R01 E65 202	THERMISTOR (HEAT SINK)		1	1	1		TH8			
31	T7W E00 233	ACT MODULE		1	1	1		ACTM			
32	T7W E04 346	NOISE FILTER BOARD		1	1	1		N.F.			
33	T7W E16 716	TERMINAL BLOCK	6P(L,N,⊙,S1,S2,S3)	1	1	1		TB1			
34	T7W 520 239	FUSE	250V 6.3A	4	4	4		FUSE1,2,3,4			
35	T7W E02 259	CONTACTOR		1	1	1		52C			
36	T7W E01 234	RESISTOR		1	1	1					
37	T7W E04 242	LINEAR EXPANSION VALVE		1	1	1		LEV(B)			
38	T7W E05 254	CAPACITOR		1	1	1		CE			

13-1. DRAIN SOCKET

Part No.	PAC-SG61DS-E
Applied models	PUHZ-RP3, 4, 5, 6VHA

13-2. AIR OUTLET GUIDE

Part No.	PAC-SG59SG-E
Applied models	PUHZ-RP3, 4, 5, 6VHA

* PUHZ-RP4, 5, 6VHA needs two piece.

13-3. DRAIN PAN

Part No.	PAC-SG64DP-E
Applied models	PUHZ-RP3, 4, 5, 6VHA

13-4. A CONTROL SERVICE TOOL

Part No.	PAC-SK52ST
Applied models	PUHZ-RP3, 4, 5, 6VHA